



# CLASSIC

7 [LEGO.com](https://www.lego.com)

10695







[LEGO.com/brickseparator](https://LEGO.com/brickseparator)



Easy building  
Einfach zu bauen  
Construction facile  
Construcción fácil  
Construção fácil  
Kezdő építőknek  
简单拼砌



Medium building  
Mittelschwer  
Construction intermédiaire  
Construcción intermedia  
Construção intermédia  
Gyakorló építőknek  
中级拼砌



Advanced building  
Fortgeschritten  
Construction avancée  
Construcción avanzada  
Construção avançada  
Tapasztalt építőknek  
高级拼砌



[LEGO.com/classic](http://LEGO.com/classic)

Page/页码  
**43**



Page/页码  
**6**



Page/页码  
**13**





Page/页码

26







1x



1x

1





2x

2



3x

3



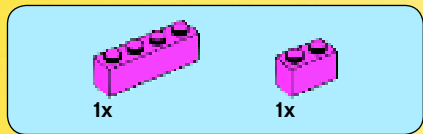

4

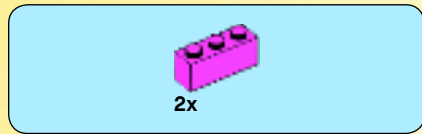

5







2x

6

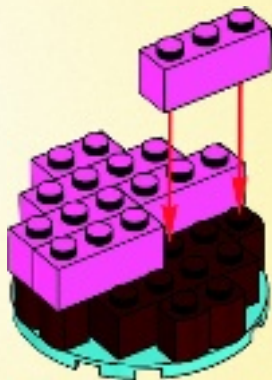

1x



1x

7





1x



1x

8



1x



1x

9





1x



1x

# 10



3x



3x

# 11





1x



1x



2x

# 12

1



2



3



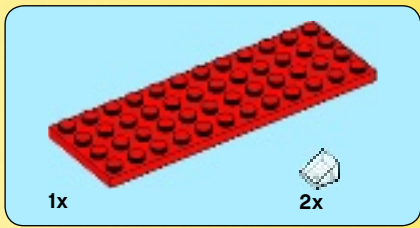

1

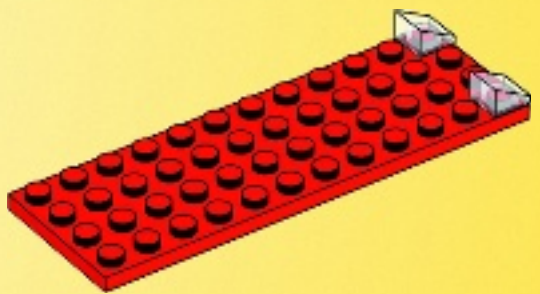

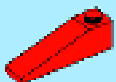

2x

2

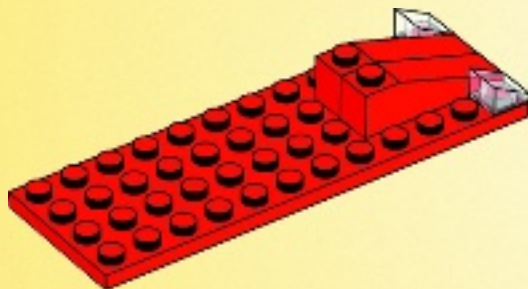





2x

3

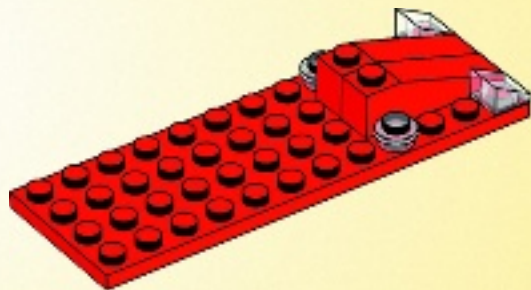

2x

4





2x



1x

5

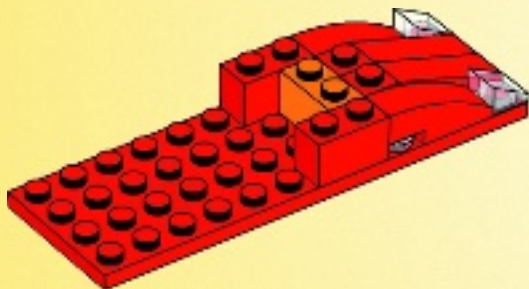



2x



2x

6

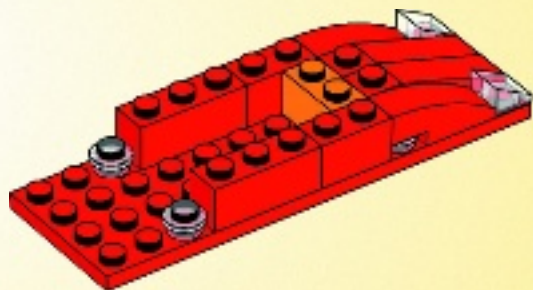

2x

7

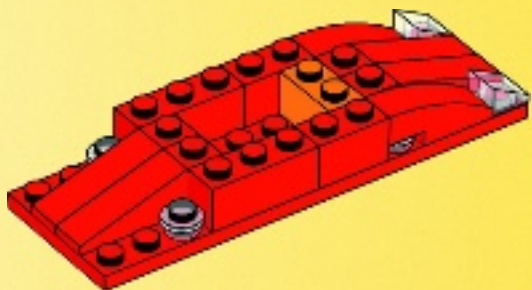



2x

8

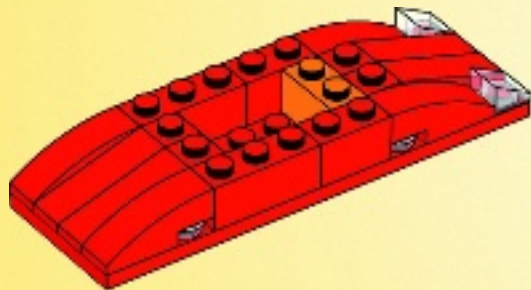

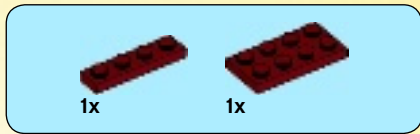

9

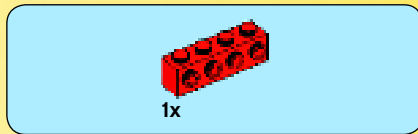
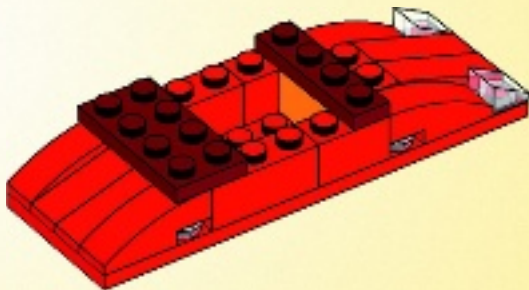

10

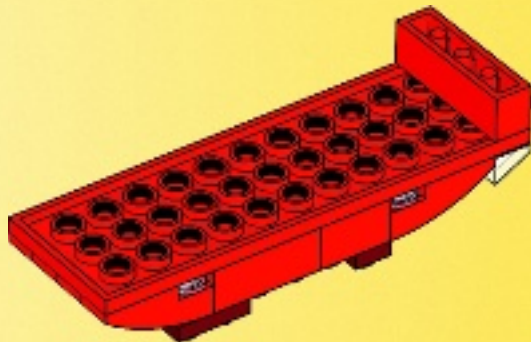
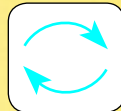



1x



2x

# 11

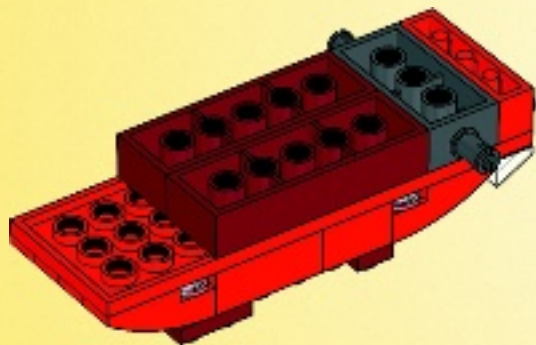





12

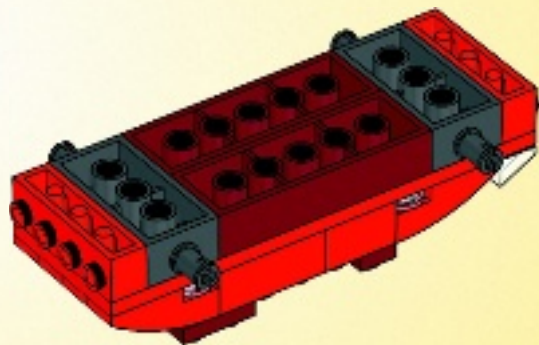

13

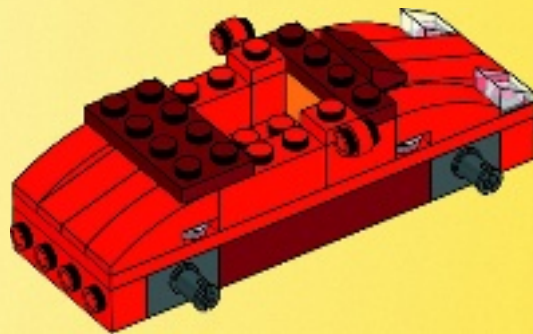
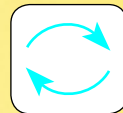



2x



1x

14

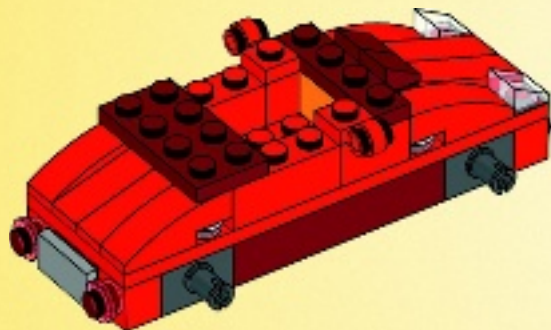



1x



1x

# 15

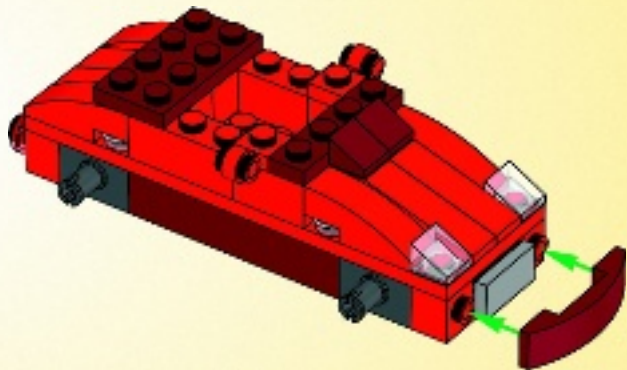

2x

# 16

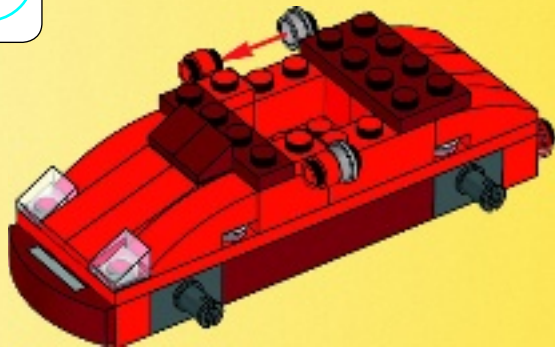
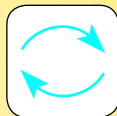



2x

17

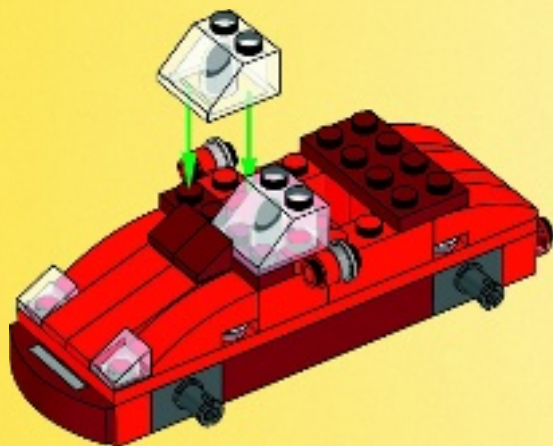

4x



1x

18

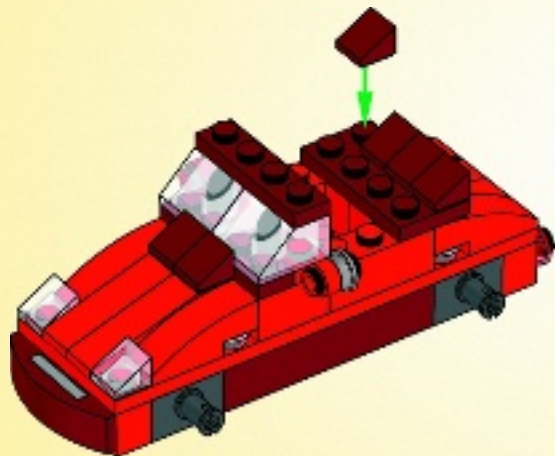



4x



4x

# 19

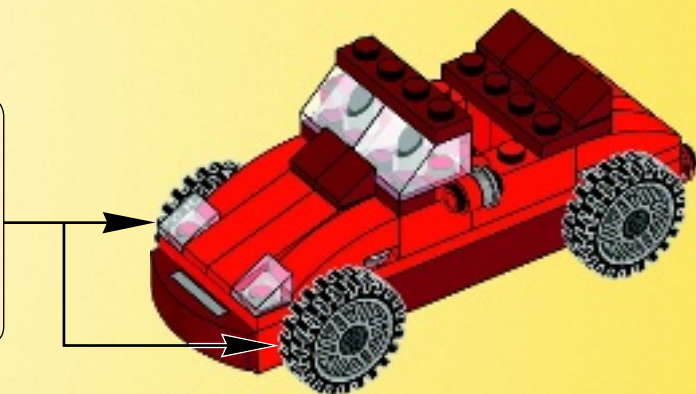



1x



1x

1







2



3





1x



2x

4





1x

5

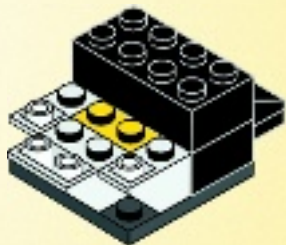

1x

6





2x



1x

7





1x



1x

8

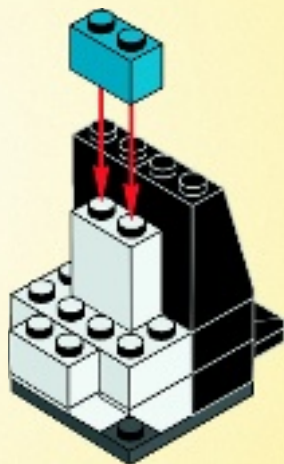

2x

9





1x

10





1x



1x

# 11



2x

# 12







13

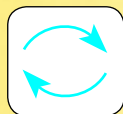



2x

14

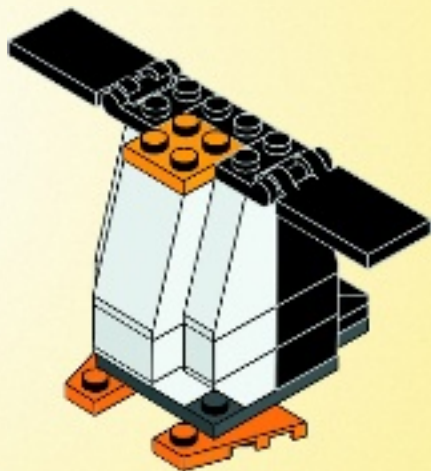
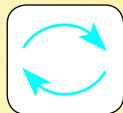

2x

15





1x

16





1x

17



1x



1x

18





2x

19





2x

# 20

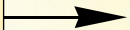

1x



2x

# 21





1x

1



2x

2







1x

3



1x

4





5

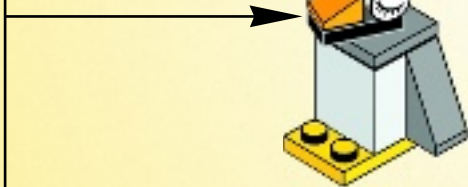



1





1x



1x

**2**

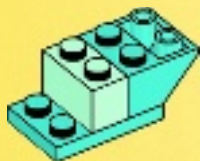

1x

**3**





1x



1x

4



1x

5





2x

6



1x



1x

7

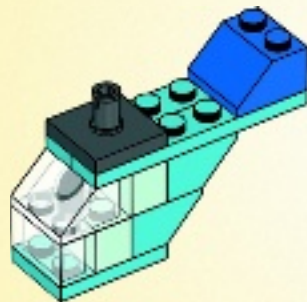

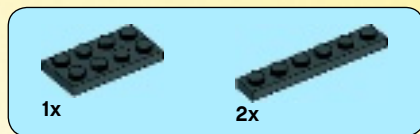

# 8

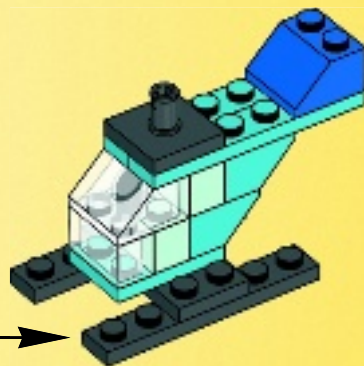
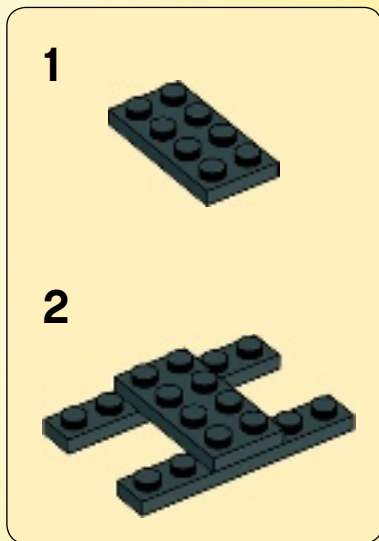



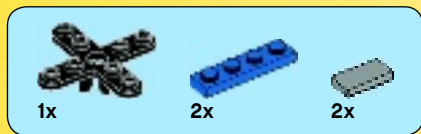

9

1



2



3

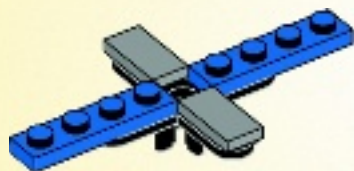

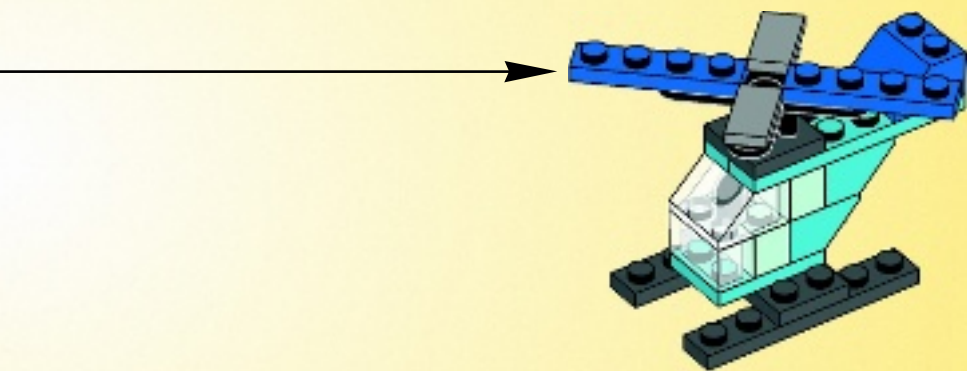



**More ideas online:**  
[LEGO.com/classic](http://LEGO.com/classic)

More ideas online:  
Weitere Ideen online:  
Plus d'idées en ligne :  
Más ideas en Internet:  
Mais ideias online:  
Online még több ötletet találsz:  
更多在线构思:  
[LEGO.com/classic](http://LEGO.com/classic)



**LEGO CLASSIC**



10692



10693

10694



10696

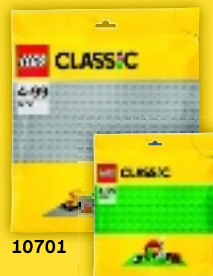

10701

10700





# LEGO CREATOR



31030



31031



31032



31033

3 IN 1

LEGO.com/creator

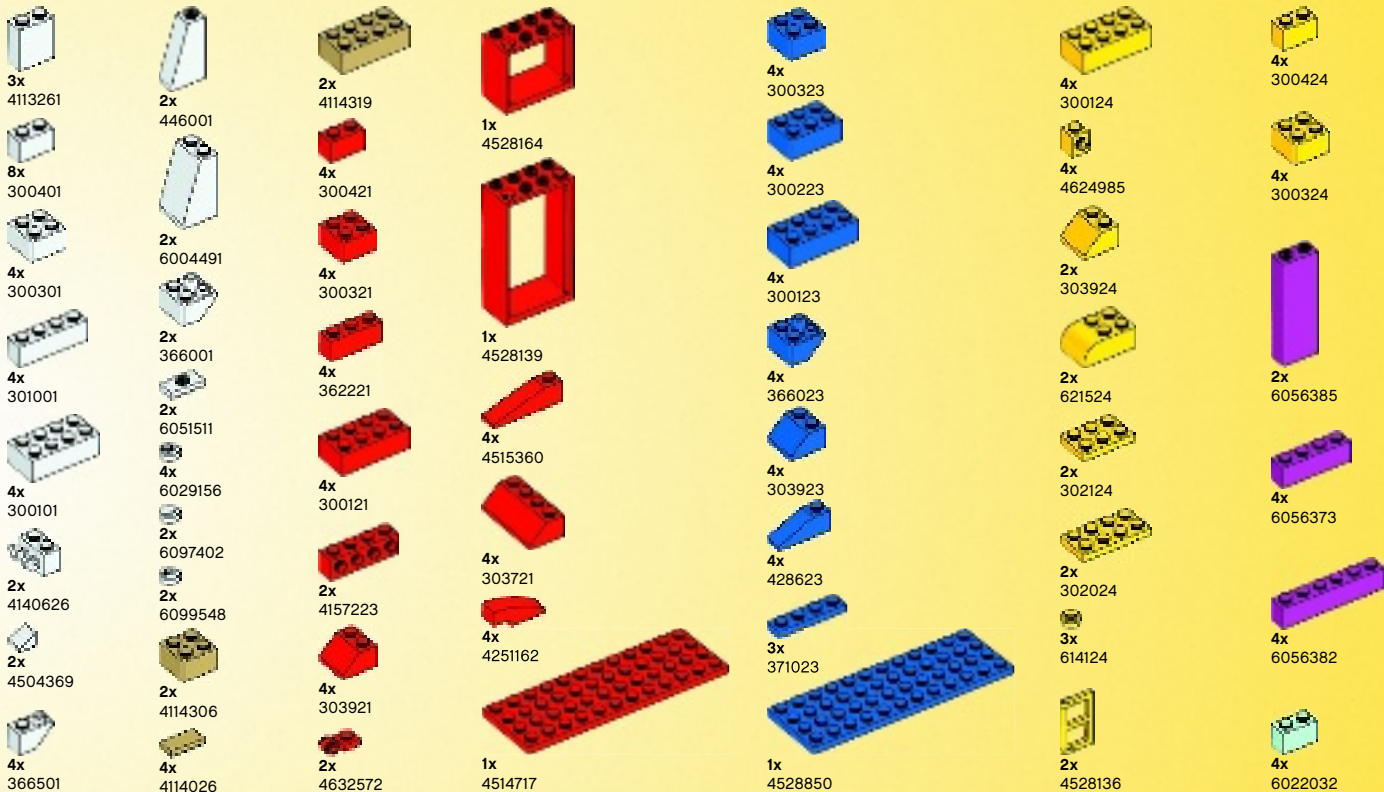



2x  
4618852



4x  
300426



4x  
300226



2x  
300126



4x  
4558954



2x  
4548180



2x  
366026



4x  
4541455



2x  
4189064



2x  
6007896



2x  
329826



2x  
6092585



2x  
302326



2x  
302226



2x  
4225201



2x  
4297713



1x  
247926



3x  
4619599



3x  
621528



4x  
302228



1x  
4583718



4x  
4647553



1x  
4617799



4x  
6096995



3x  
4142898



6x  
3005740



3x  
3005741



4x  
306544



3x  
3005748



8x  
4579659

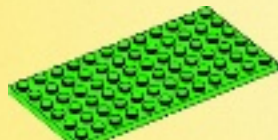

1x  
4541414



4x  
4164022



4x  
4220632



4x  
4165967



2x  
4621548



4x  
306540



3x  
4244362



5x  
622740



2x  
6092599



2x  
4158355



1x  
4180540



1x  
4180512



8x  
4121739



4x  
4153826



4x  
4118828



4x  
4118829



4x  
4251969



4x  
4625027



12x  
4651903



4x  
4655173



4x  
4625024



2x  
6070777



4x  
4619524



1x  
4654448





Customer Service

Kundenservice

Service Consommateurs

Servicio Al Consumidor

LEGO.com/service or dial



: 00800 5346 5555

: 1-800-422-5346