



# NEXO KNIGHTS



70314



LEGO.com/nexoknights





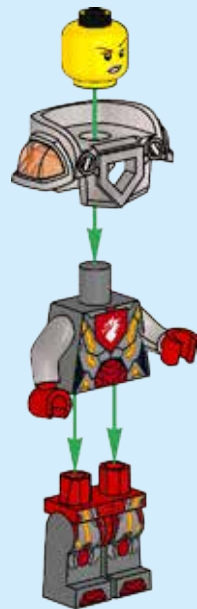

1

2

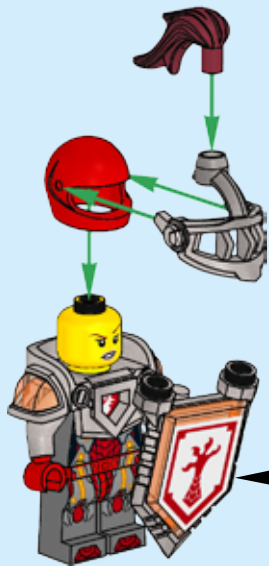

1



2



3



3



1



2



3



**1**

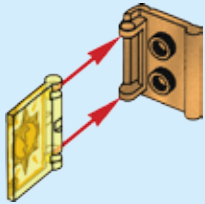

**2**

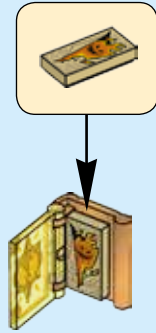

**3**



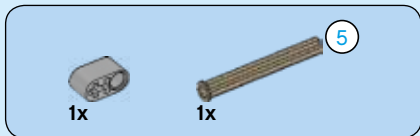

1

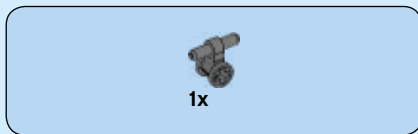
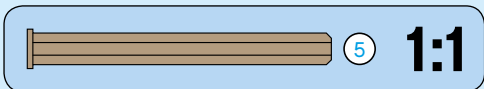
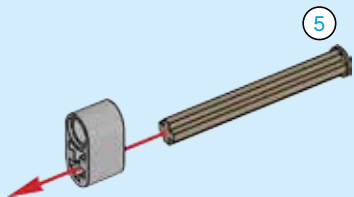

2

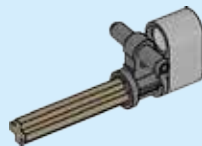



3x

3

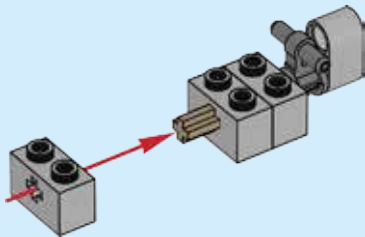

8



1x



1x



1x

4

1

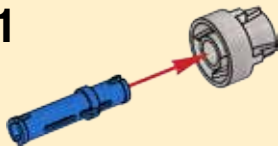

2

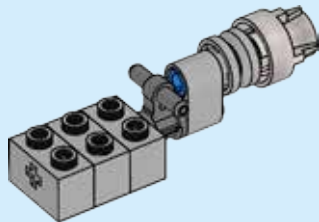
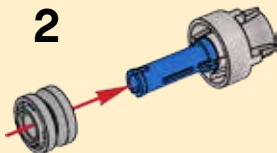





2x

5

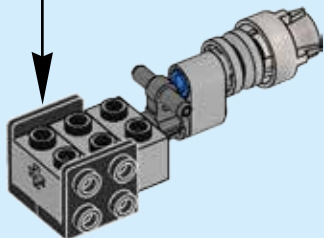
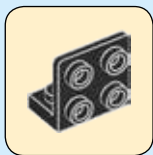

1x



1x

6

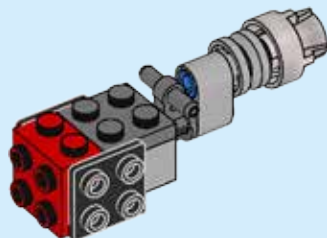



2x

7

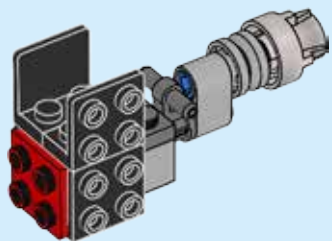

2x

8

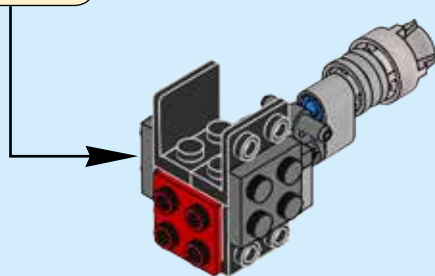



2x

9

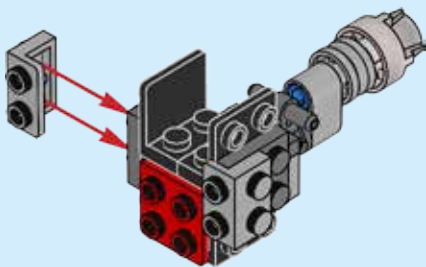

2x

10

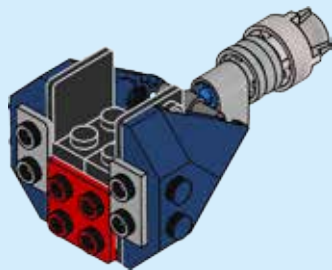



1x



2x

# 11

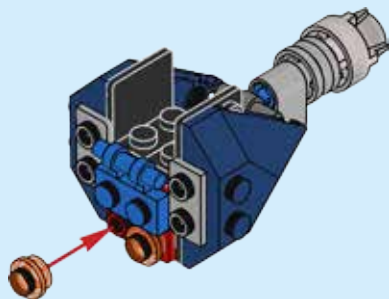

2x

# 12

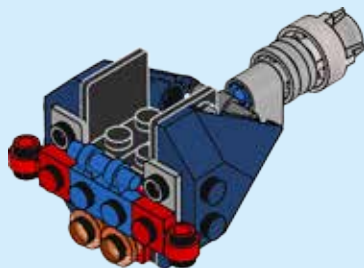



2x



2x

# 13

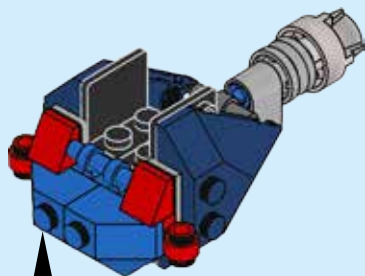

2x



2x

# 14

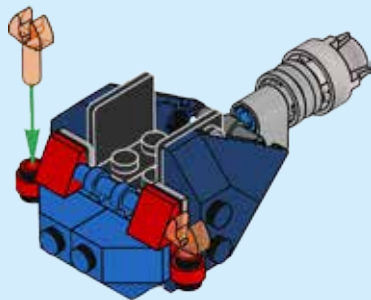



15

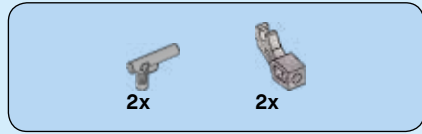
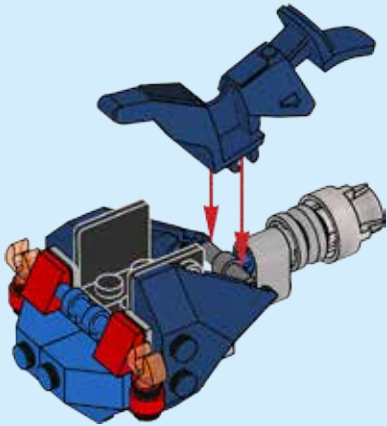

16

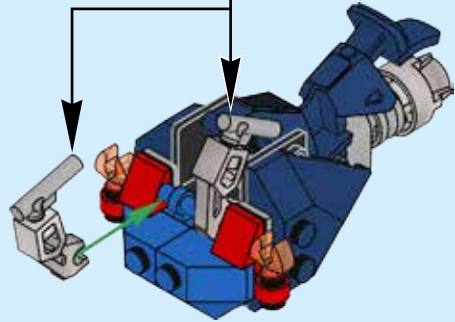
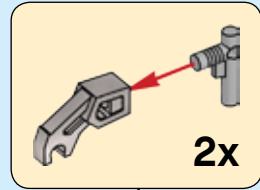

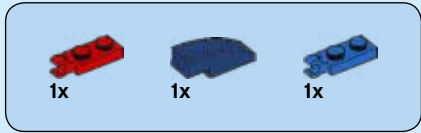

17

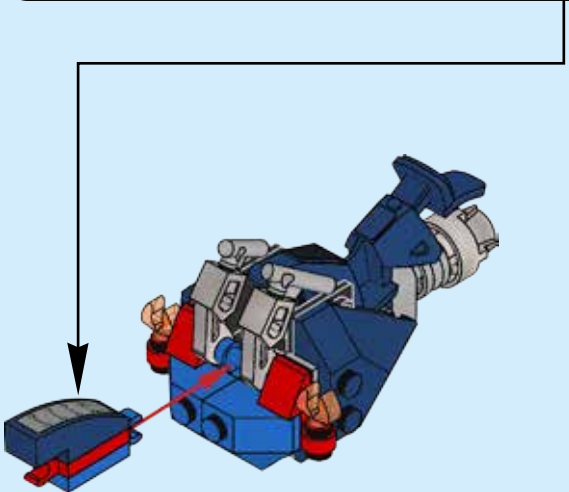
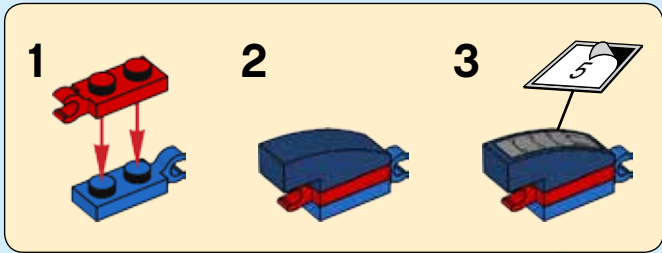



18

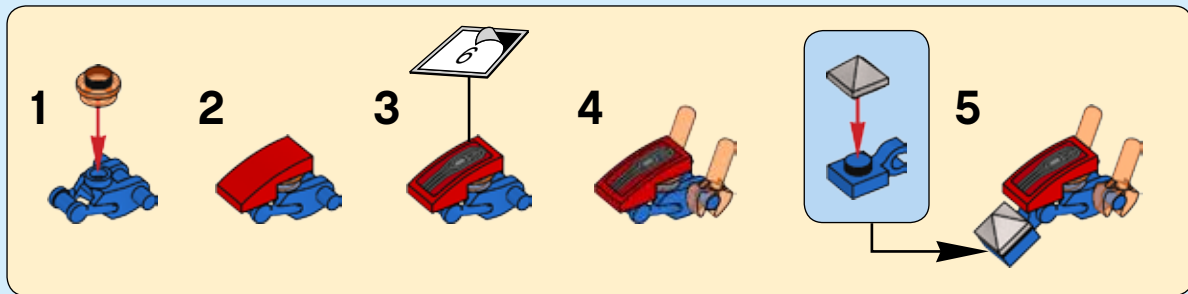



19



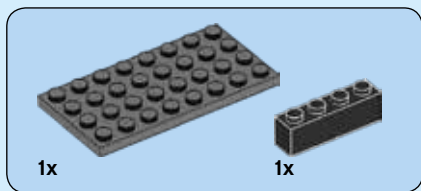
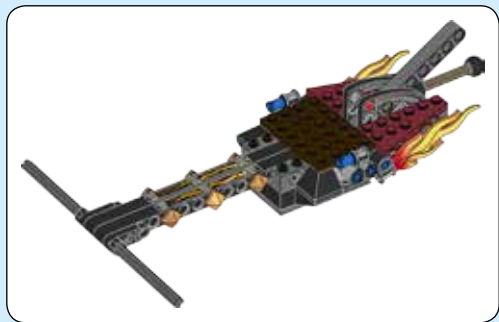

**1**

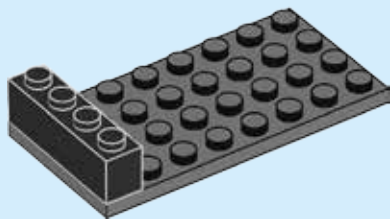



2x

2

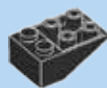
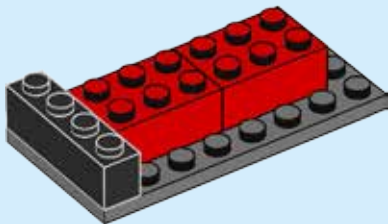

5x

3

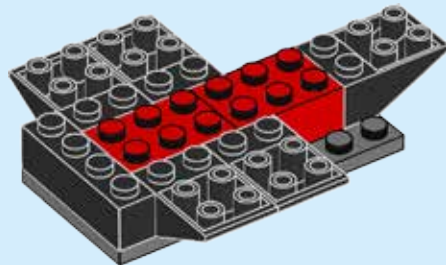



2x

4

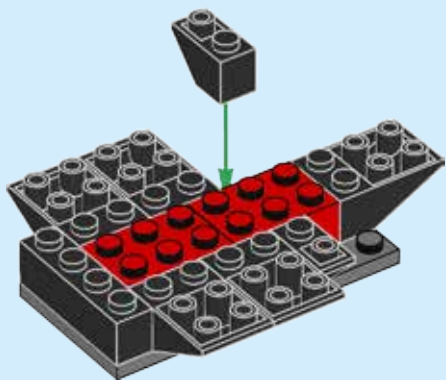

1x



1x

5

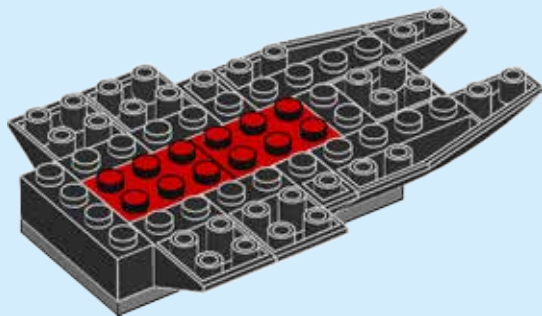

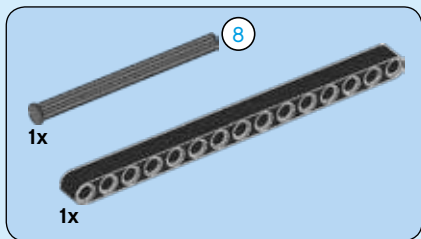
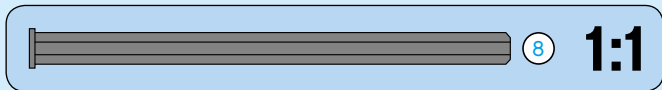

6

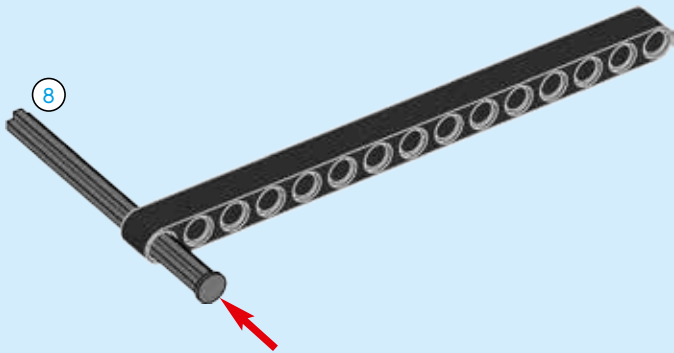



1x

7

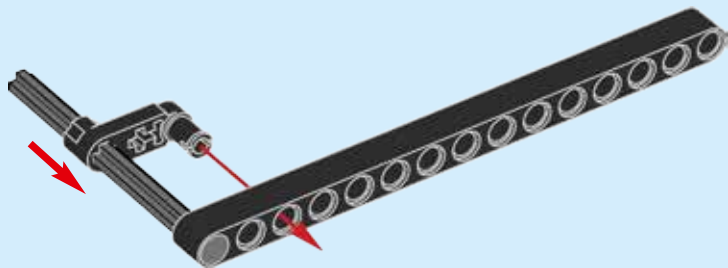



4x

8

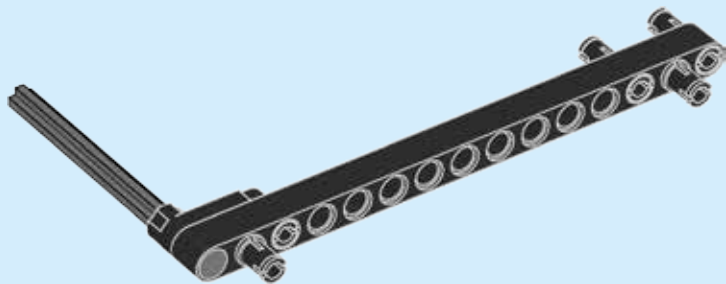



9

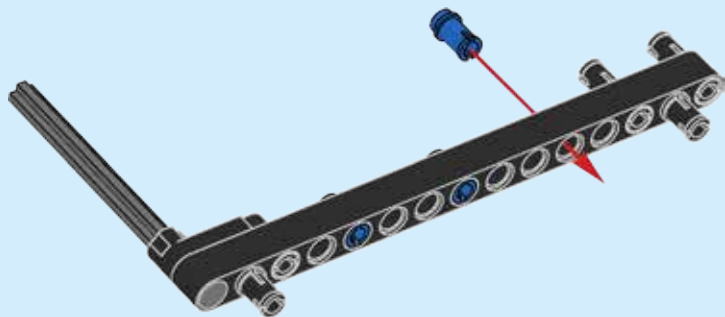



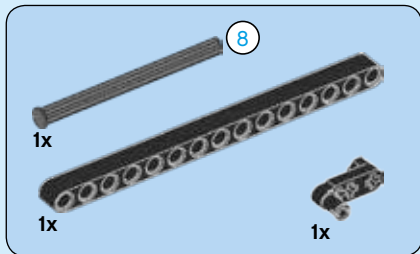

**10**

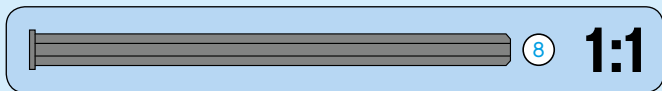
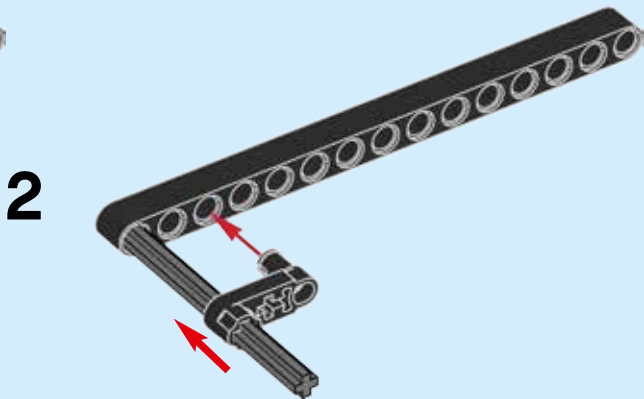
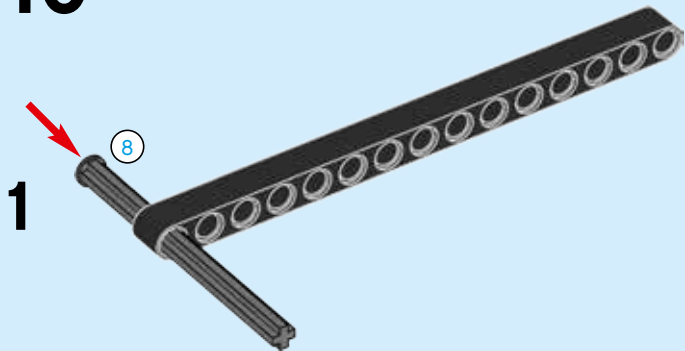

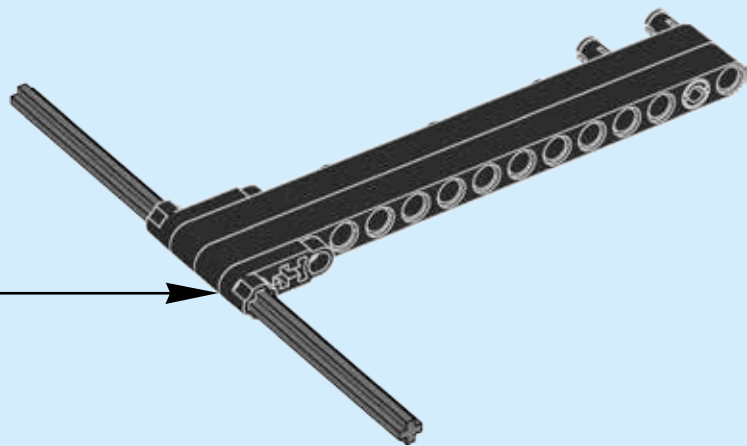



2x



3x

# 11

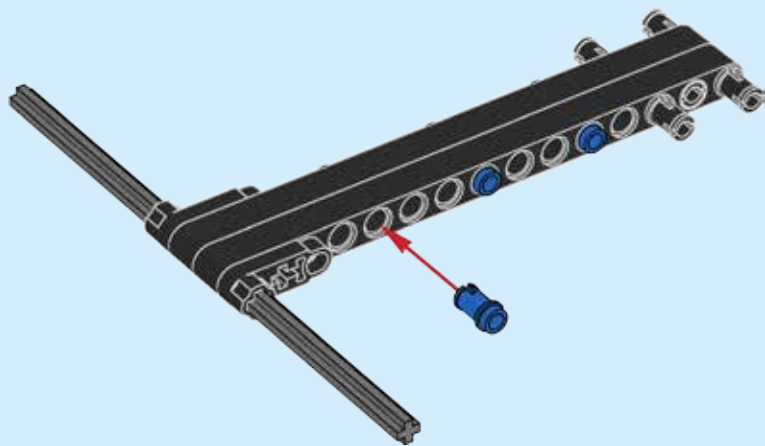

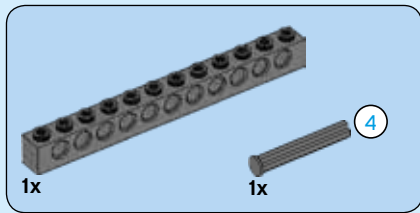

12

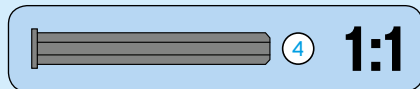
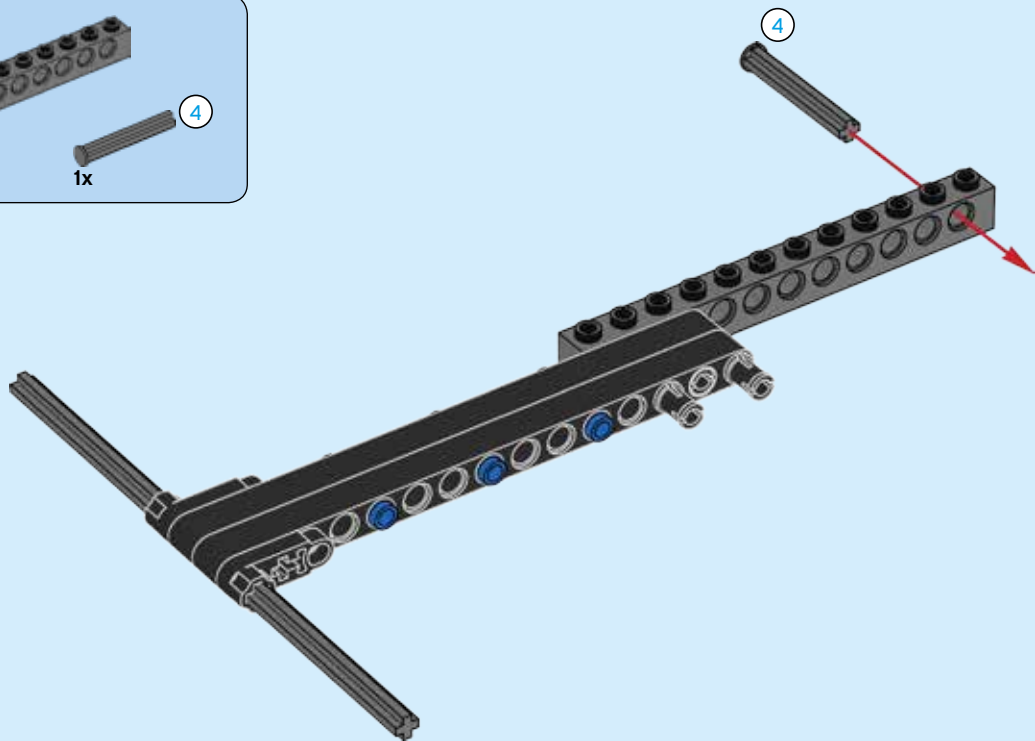

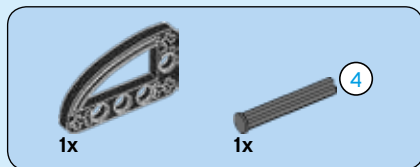

# 13

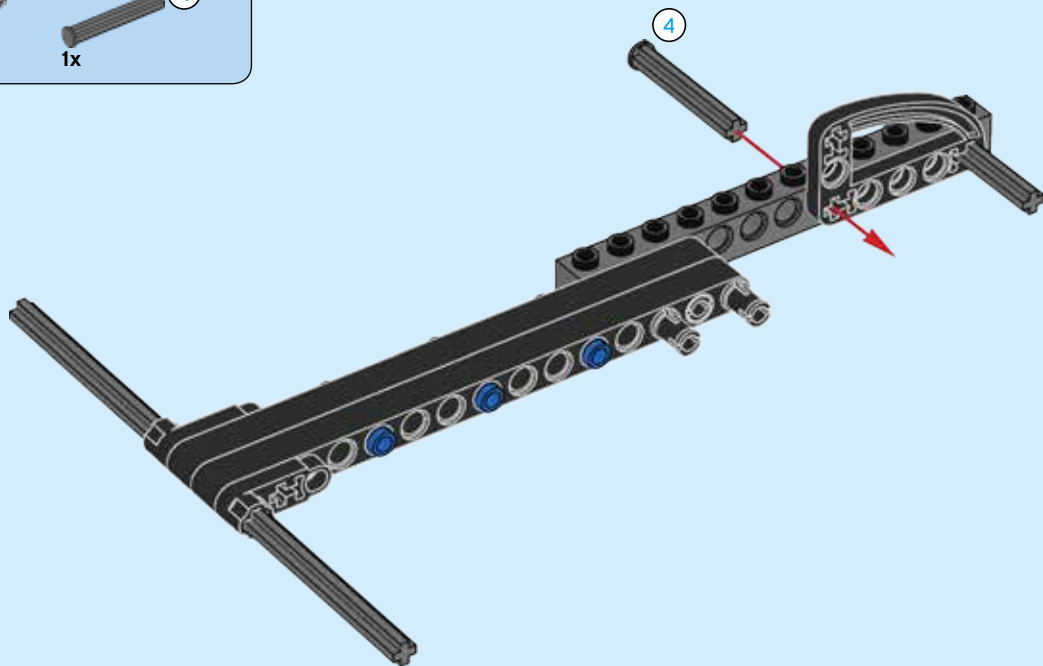



1x

14

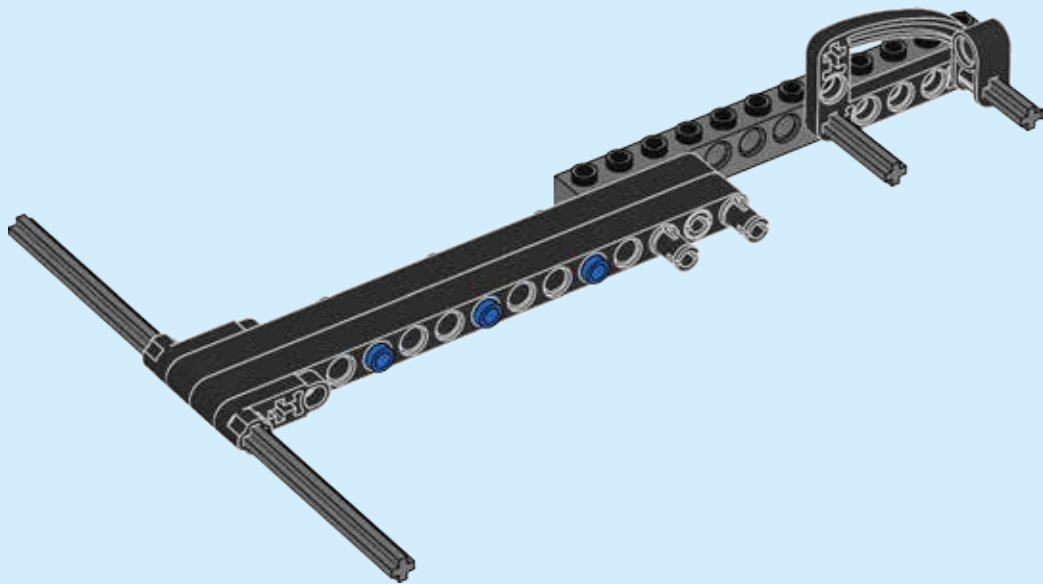

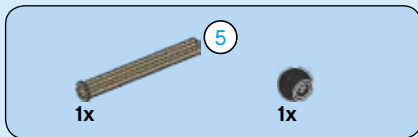

15

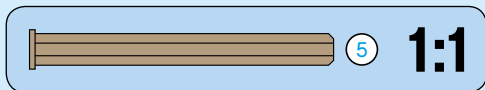
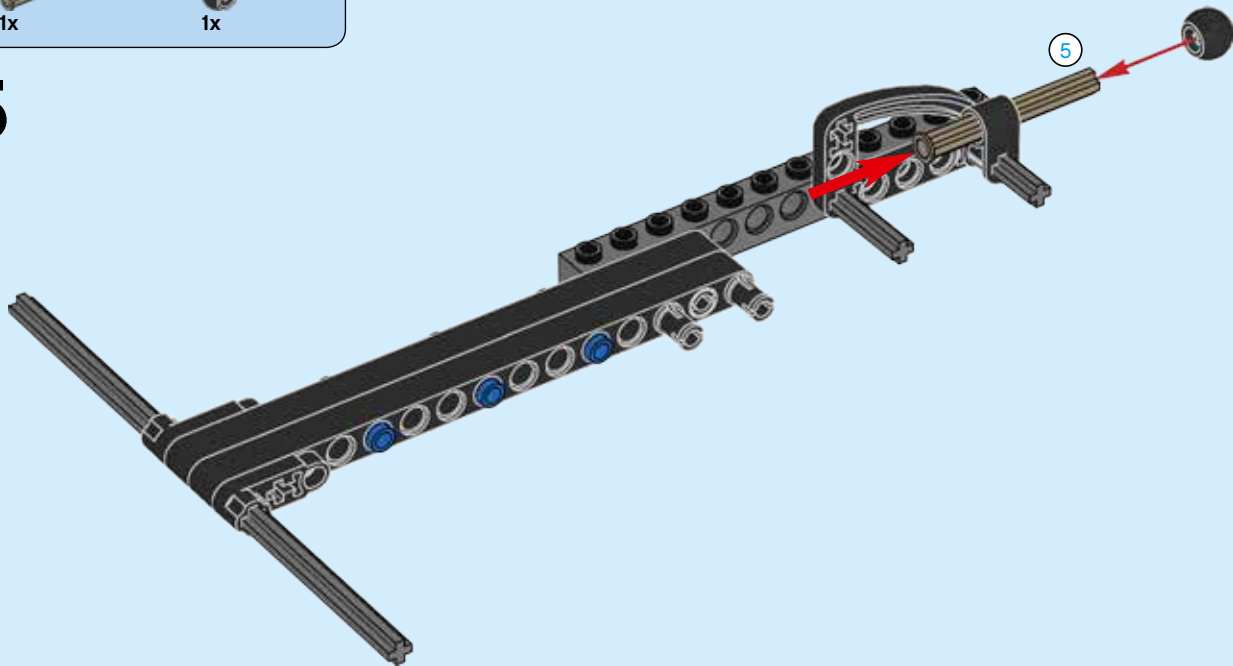



1x



1x

# 16

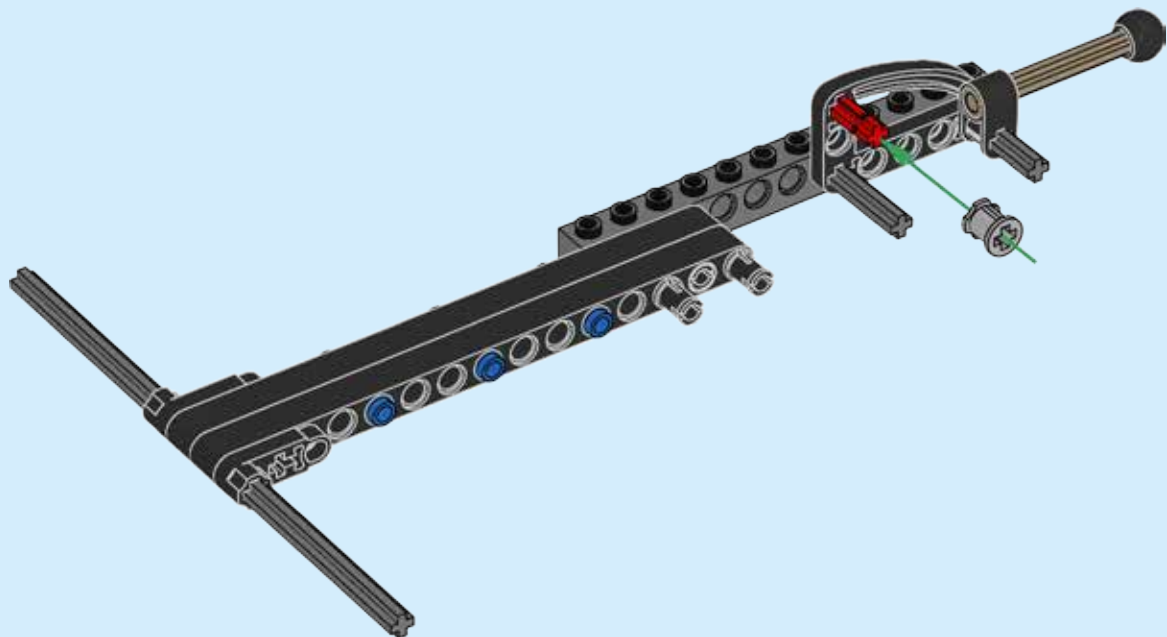



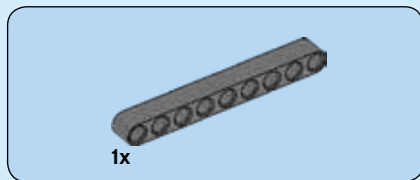

17

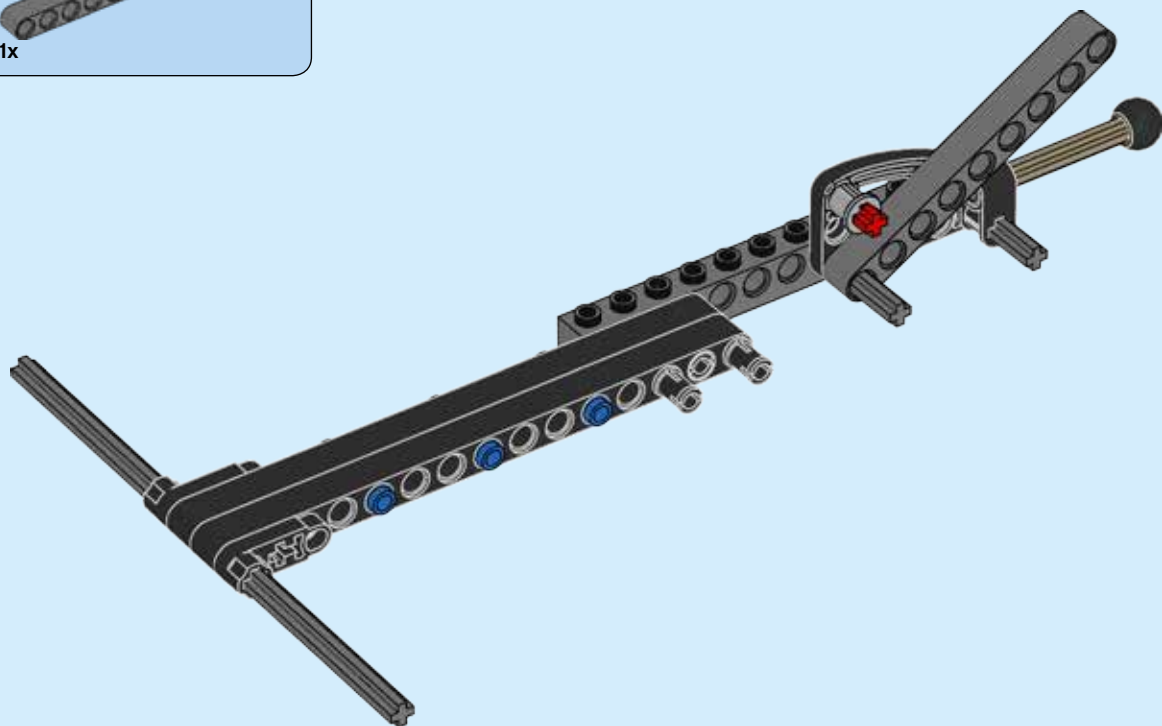



18

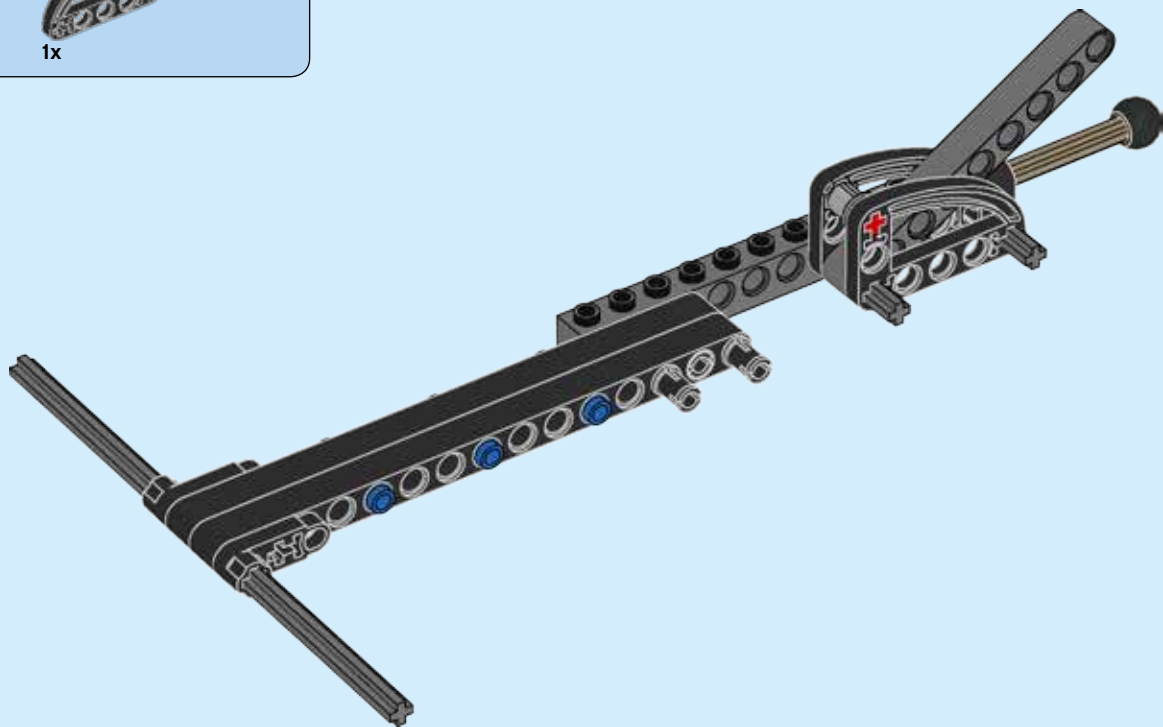

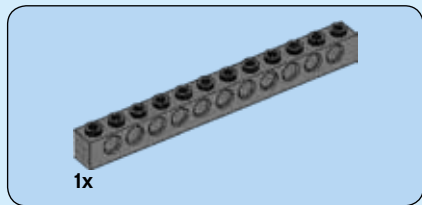

19

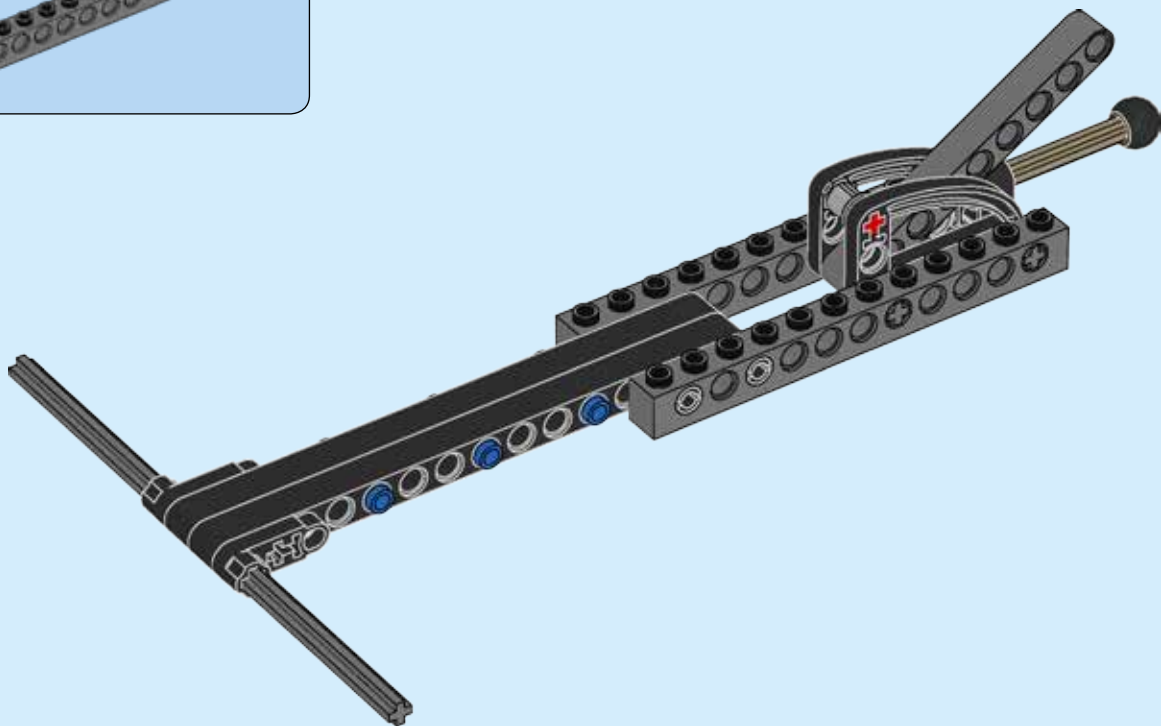

20

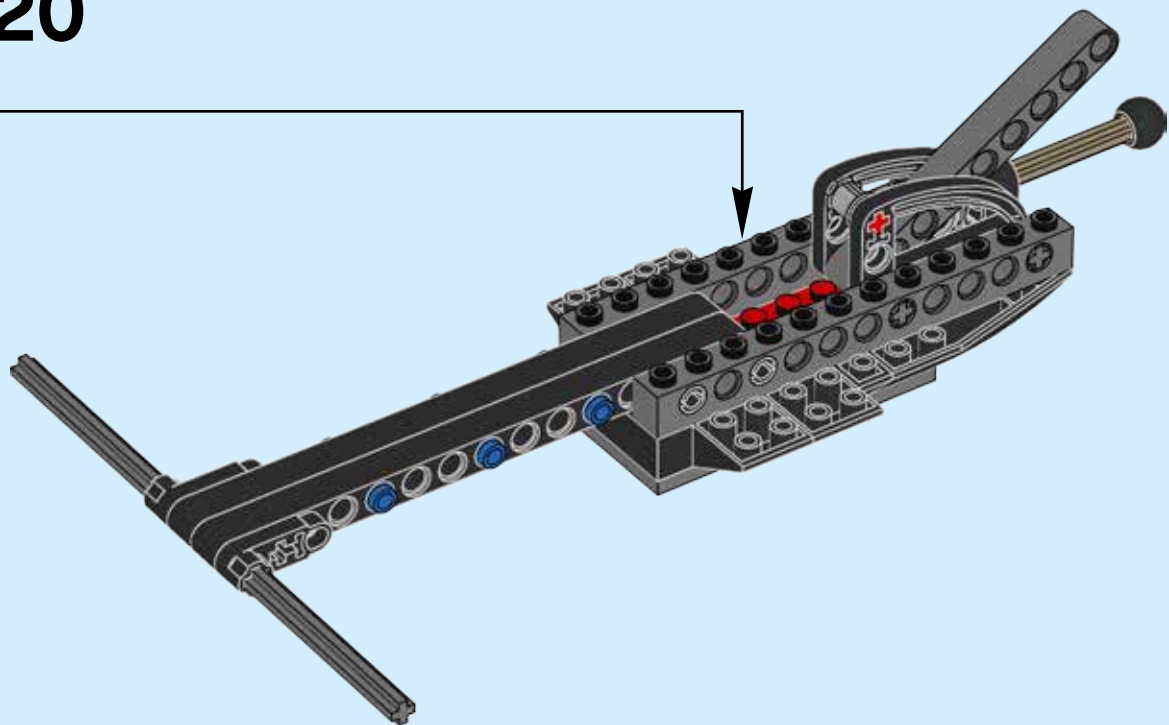



6x

21

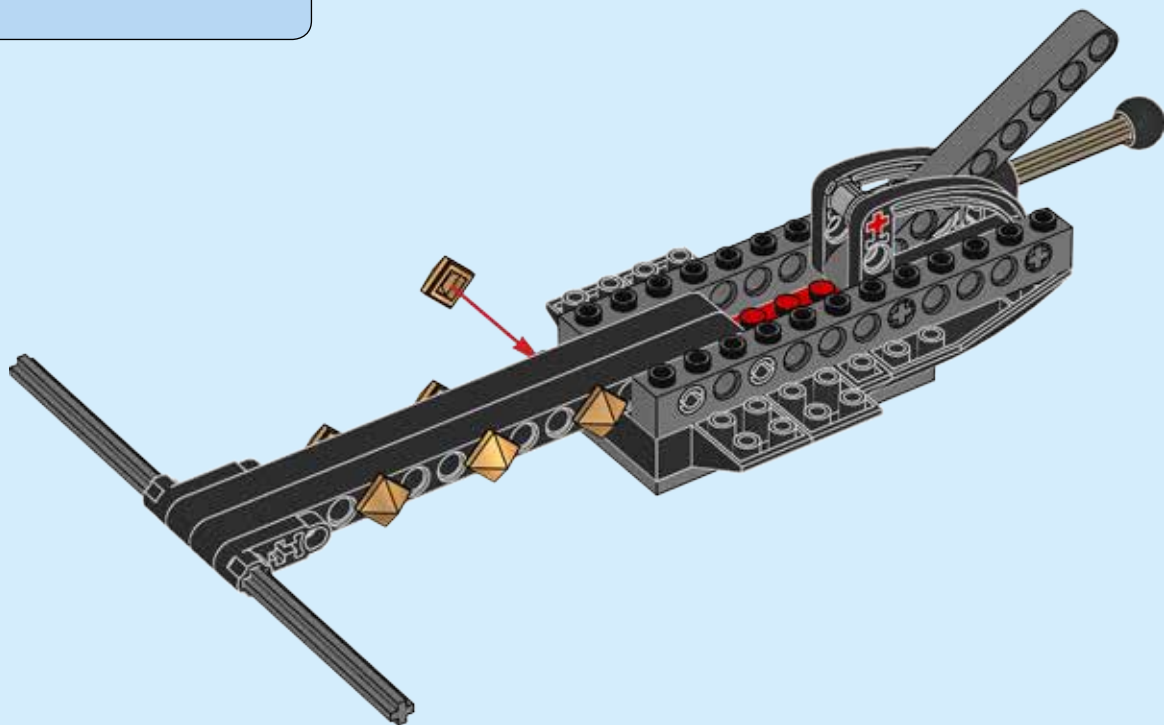



2x

22

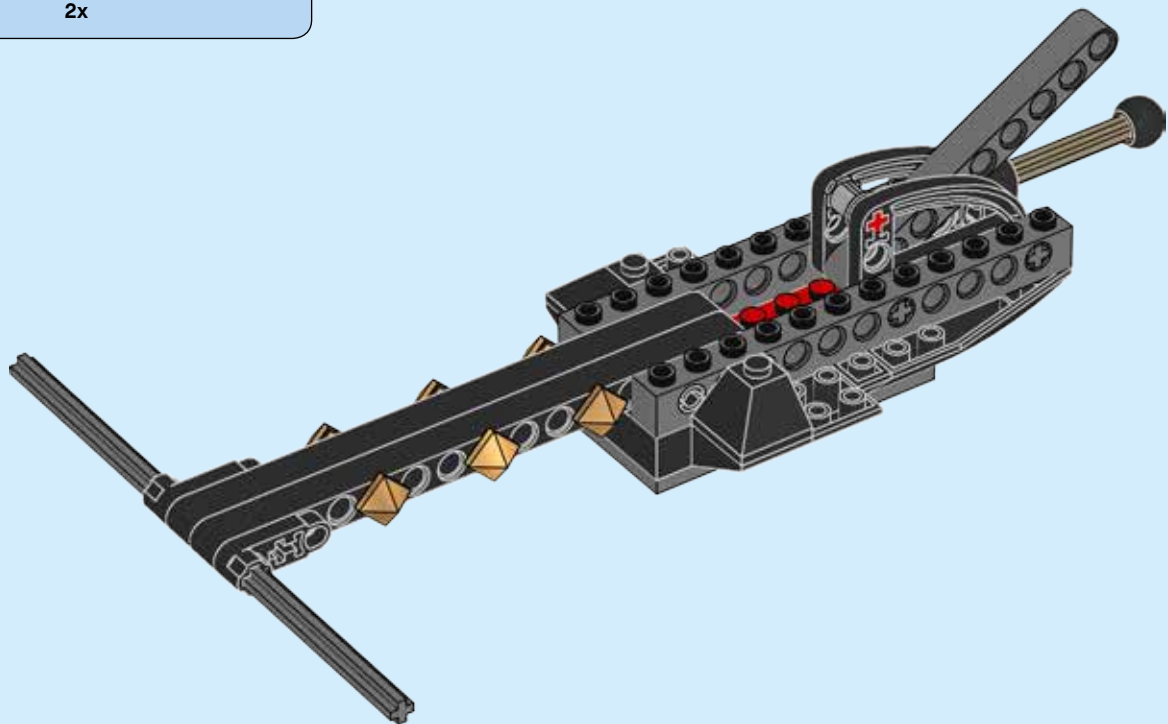

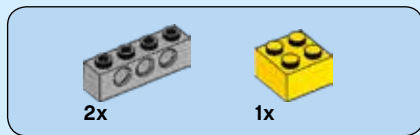

23

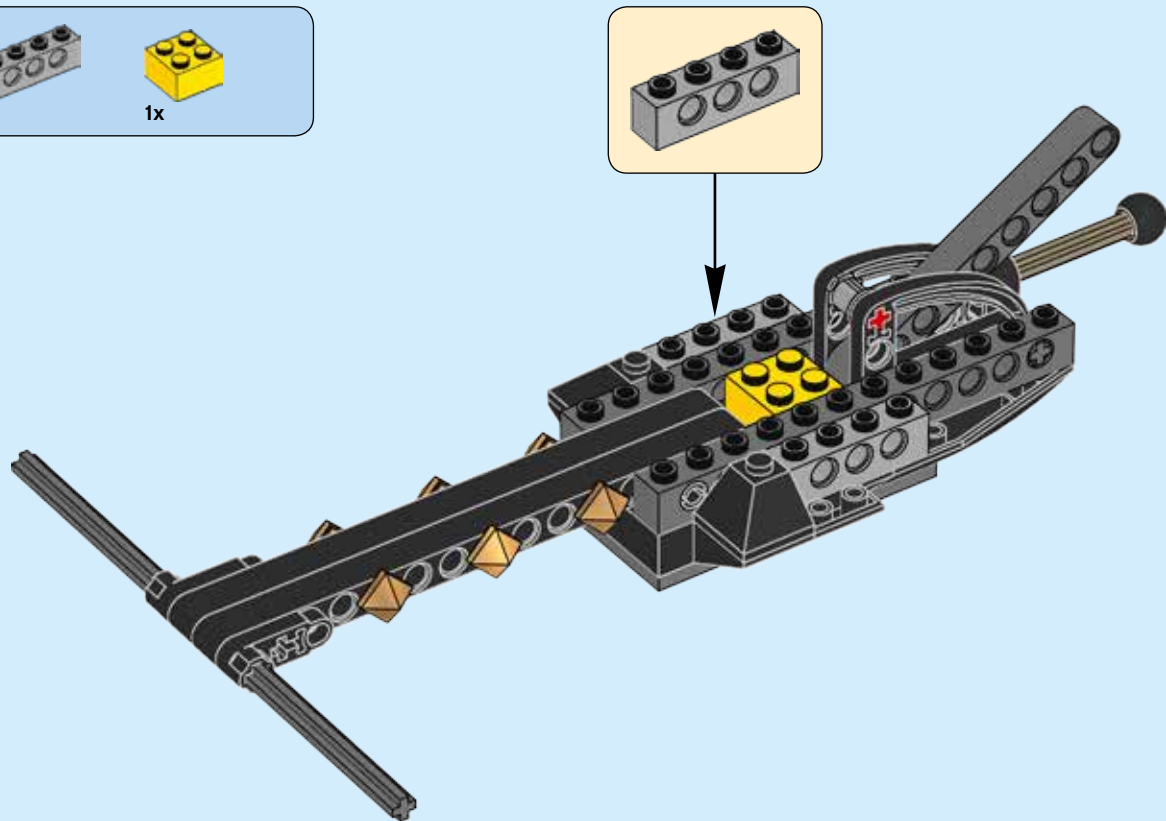



6x

24

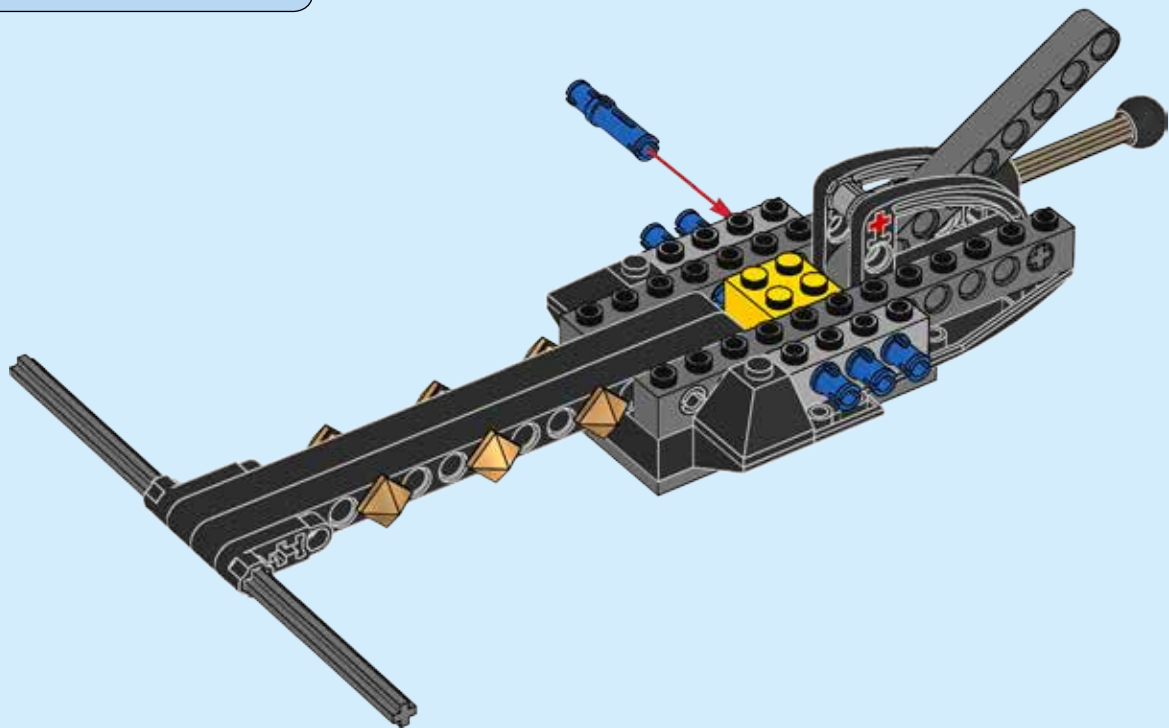





25

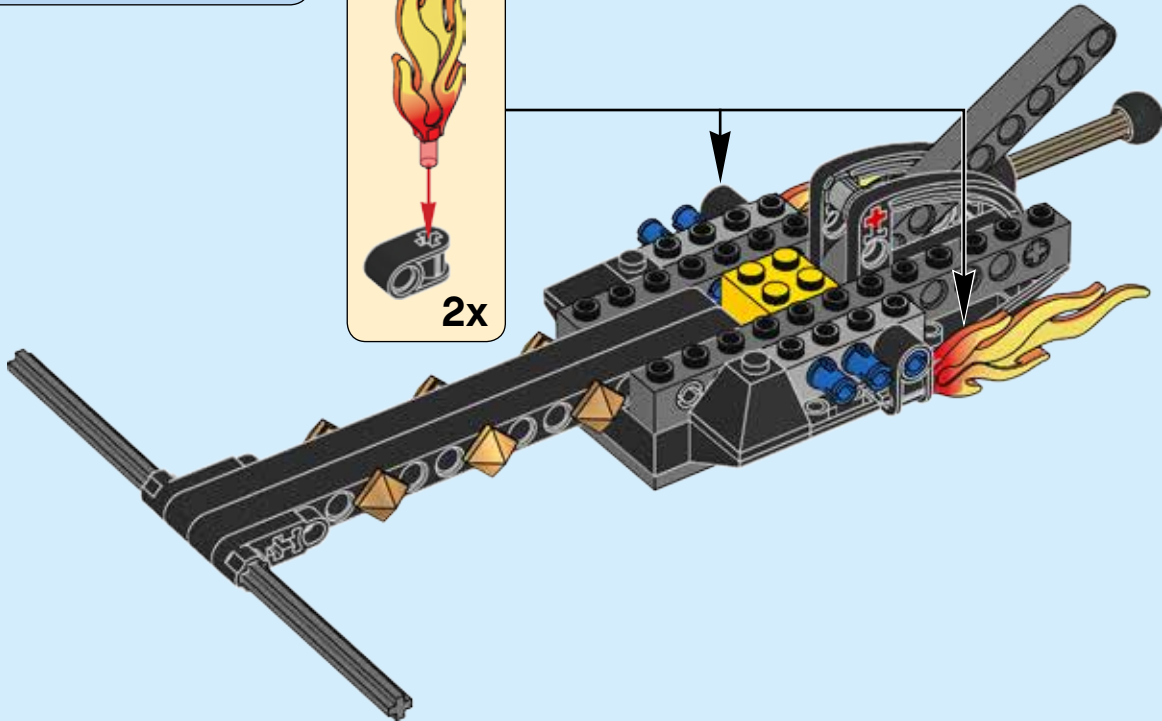

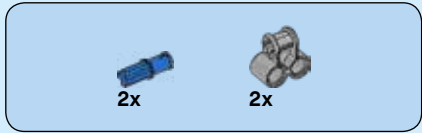

26

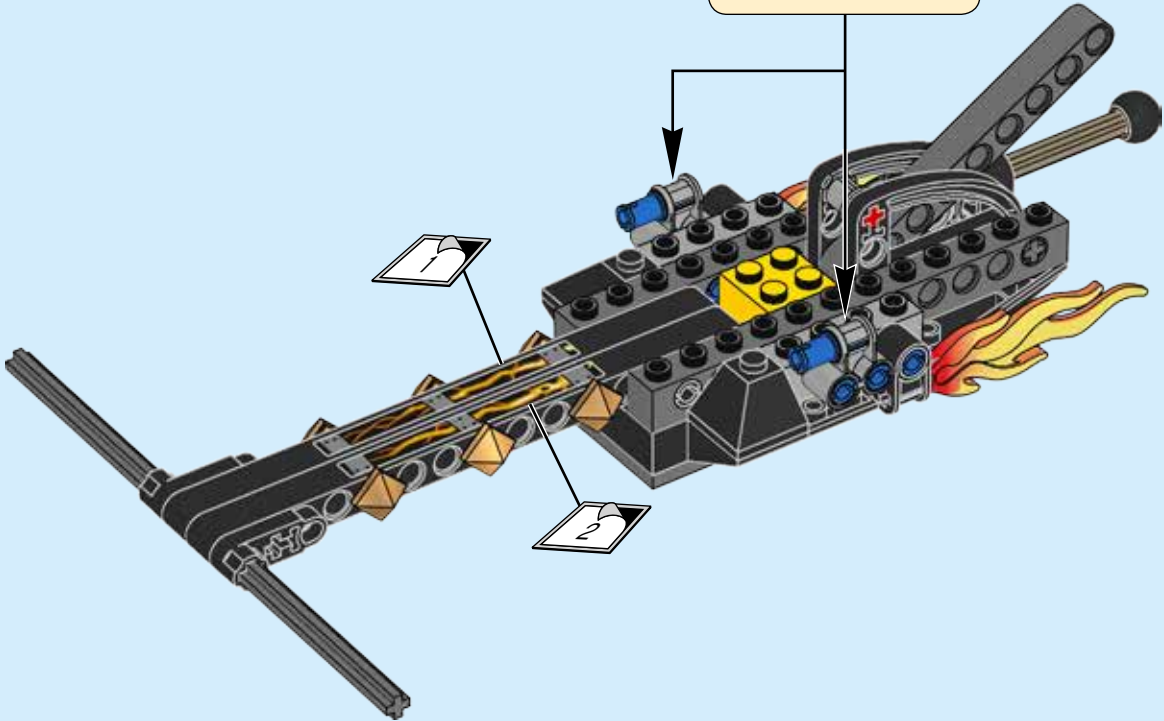
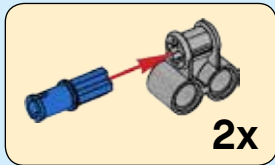



2x

27

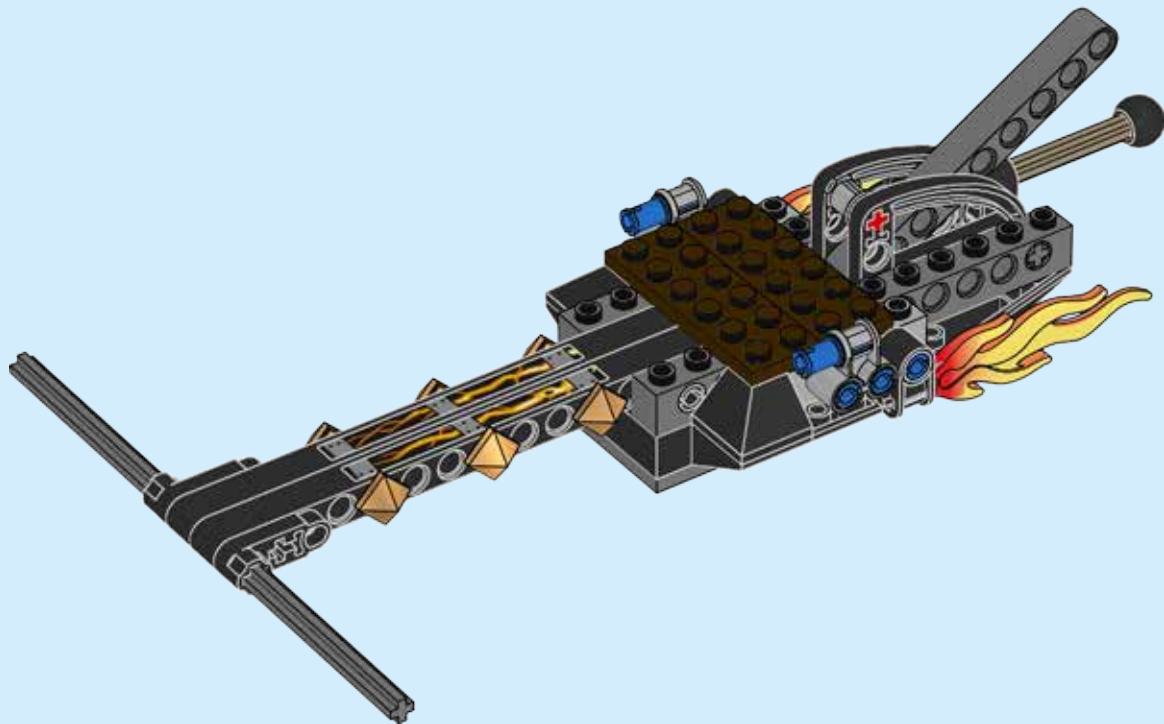

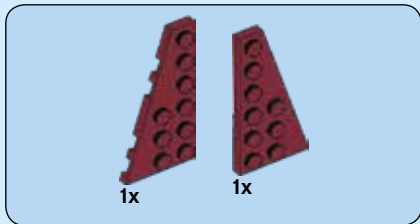

28

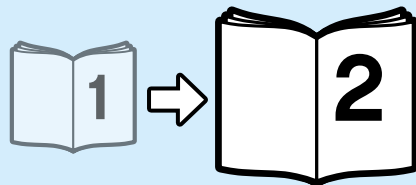
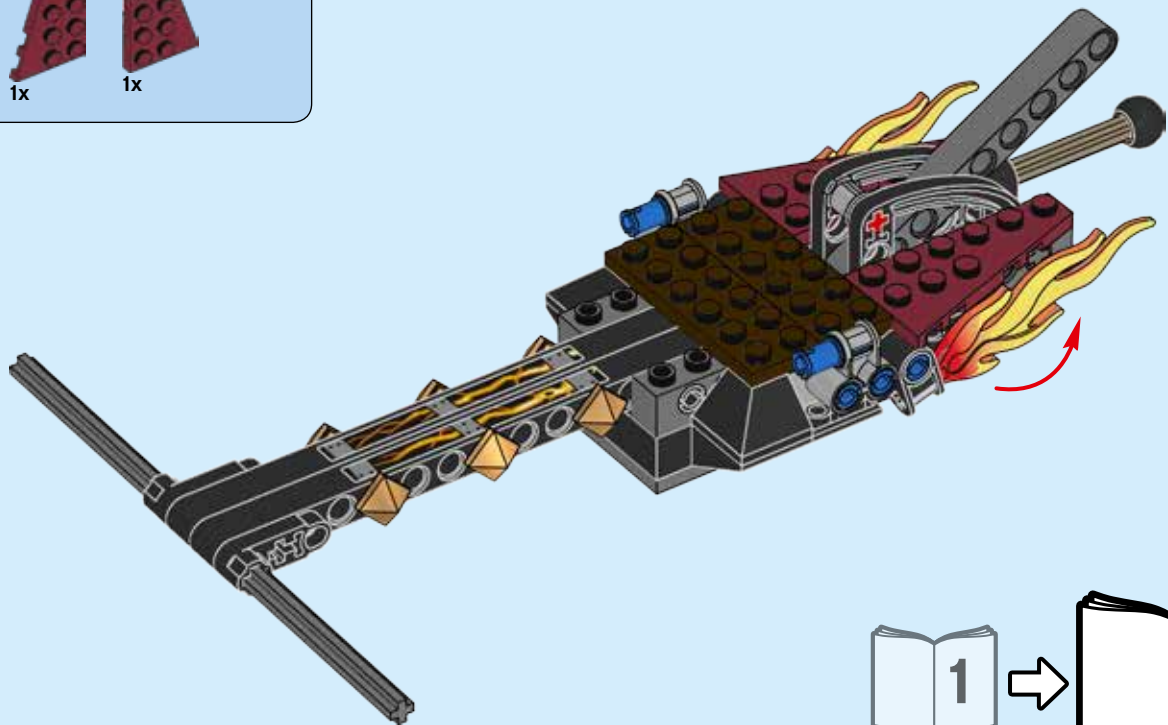

**LEGO**

**NEXO  
KNIGHTS**



70330



70331



70332



70333



70334



70335



# NEXO KNIGHTS



ULTIMATE BEAST MASTER  
70334

ULTIMATE LAVARIA  
70335



SPARKKS  
70316



JESTRO  
70316



BOOK OF MONSTERS  
70316



MOLTOR  
70313



BEAST MASTER  
70314



CRUST SMASHER  
70311



ASH ATTACKER  
\* 70310 / 70315 / 70317



FLAME THROWER  
70312



SCURRIER  
\* 70315 / 70317

\* Weapons and decorations vary by set/Zubehör und Dekoration variieren je nach Set/Les armes et les décorations varient selon les boîtes/



ULTIMATE CLAY  
70330

ULTIMATE MACY  
70331

ULTIMATE AARON  
70332

ULTIMATE ROBIN  
70333



AARON  
\* 70313 / 70317



AXL  
70317



LANCE  
\* 70312 / 70316



MACY  
70314



CLAY  
\* 70315 / 70317



CHEF ÉCLAIR  
70317



LANCE BOT  
70312



CLAY BOT  
70315



ROYAL SOLDIER  
\* 70310 / 70311



MERLOK 2.0  
70317



Las armas y accesorios varían según el set/As armas e decorações variam consoante o conjunto/A fegyverek és dekorációk készletenként változnak./套装不同，武器和装饰各有不同



# club™

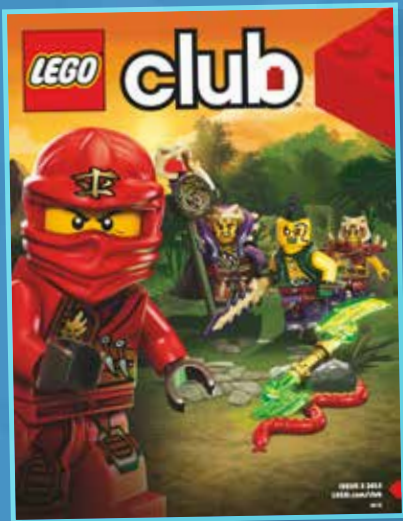

1



[LEGO.com/club](http://LEGO.com/club)

2



3







# NEXO KNIGHTS



70314



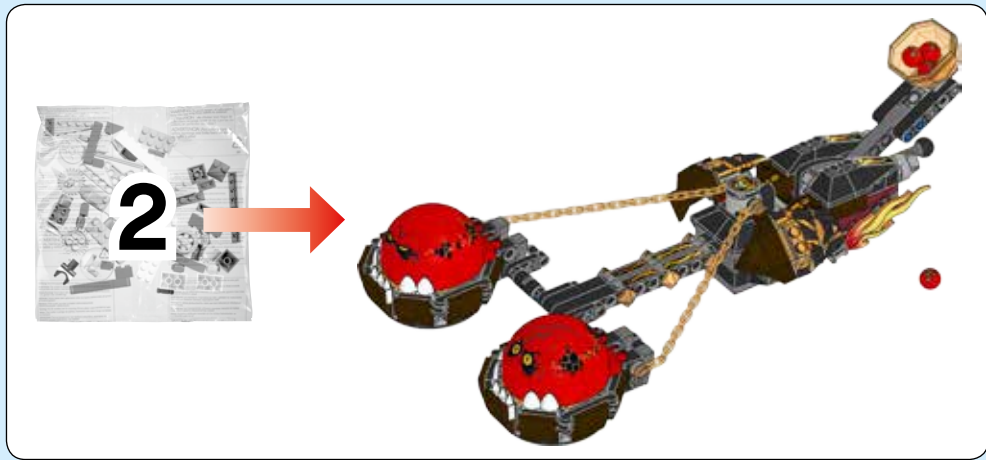

29

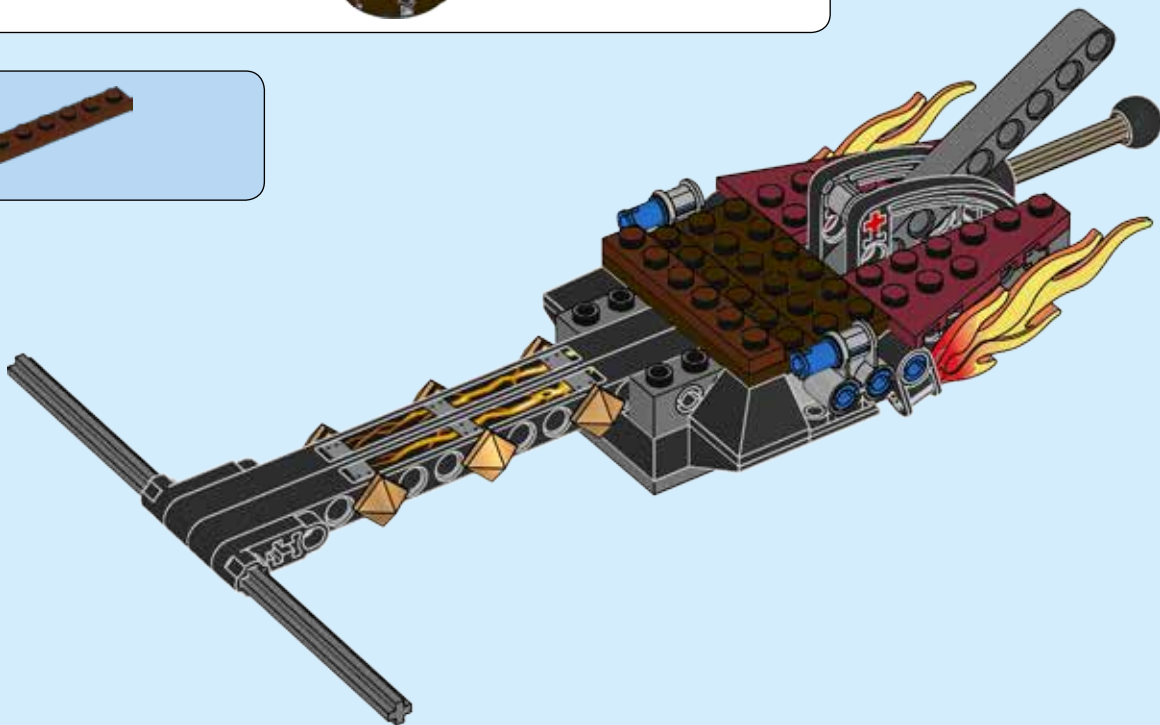

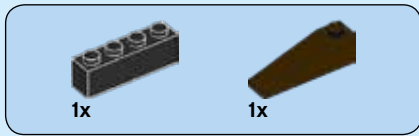

30

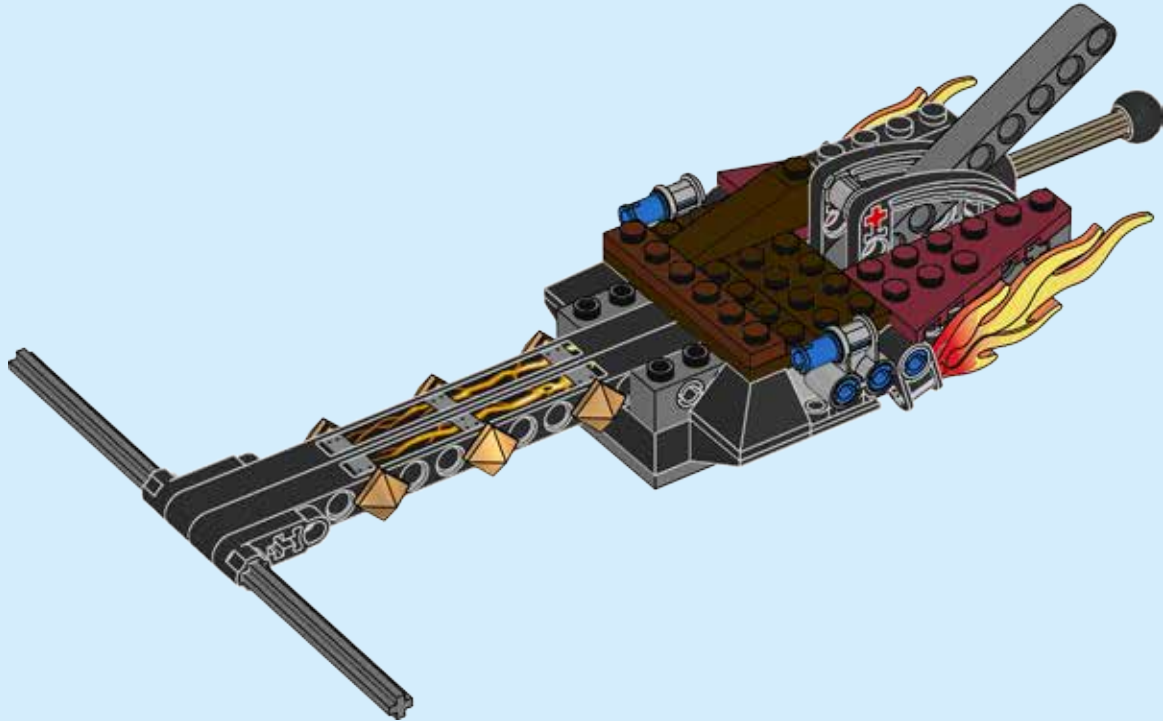



1x



1x

# 31

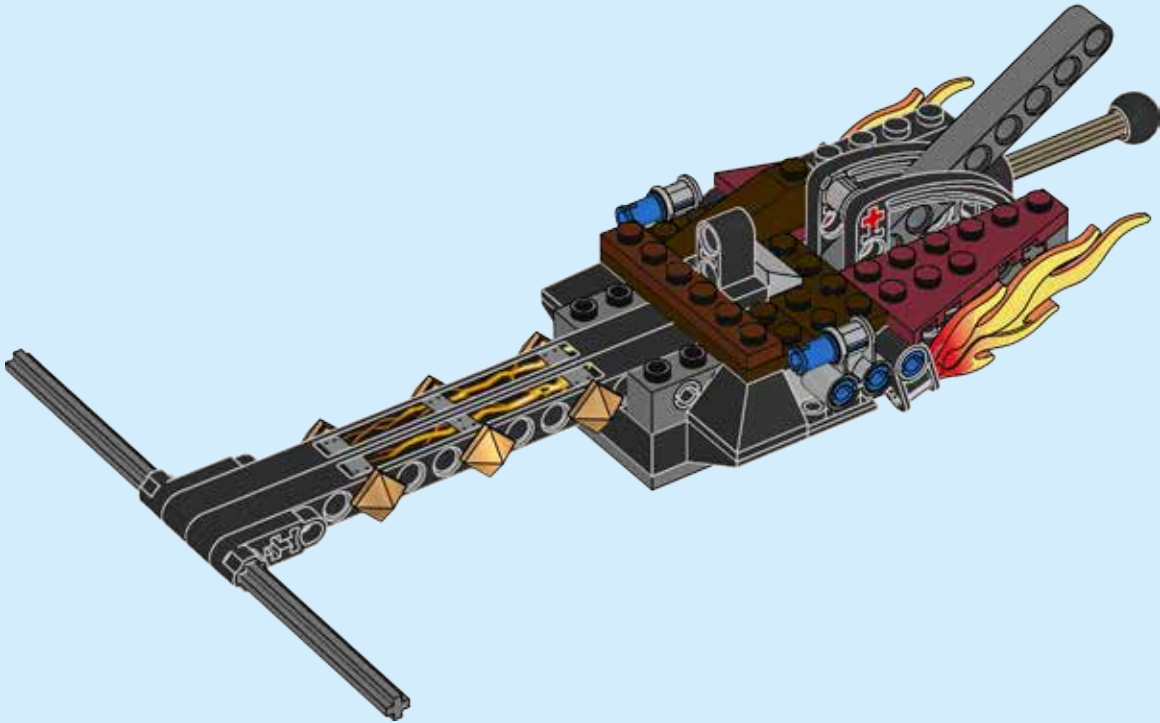

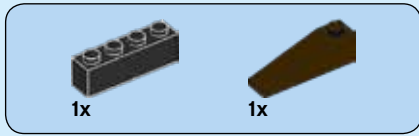

32

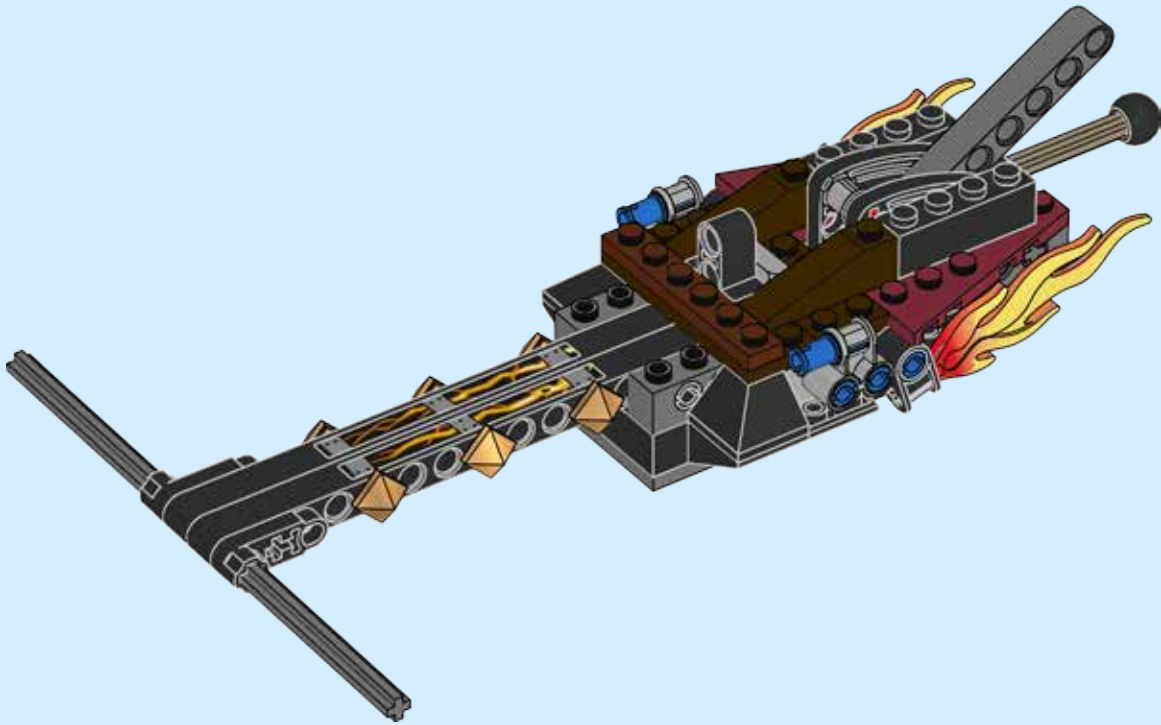

# 33

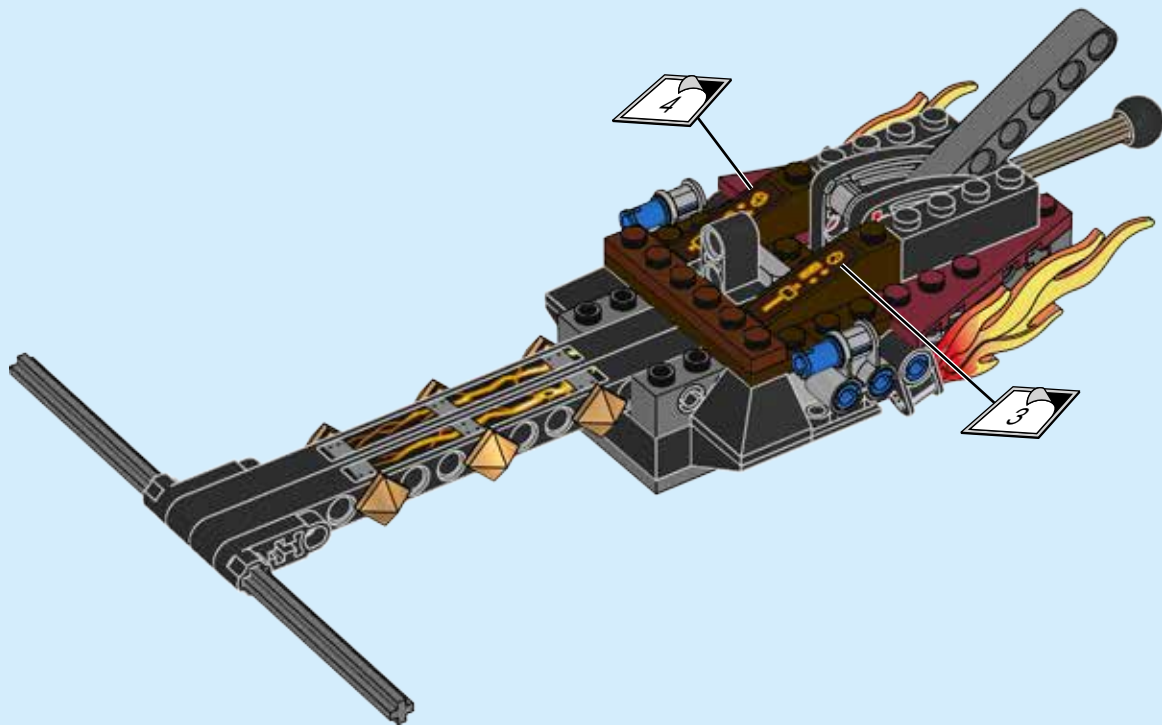



4x

# 34

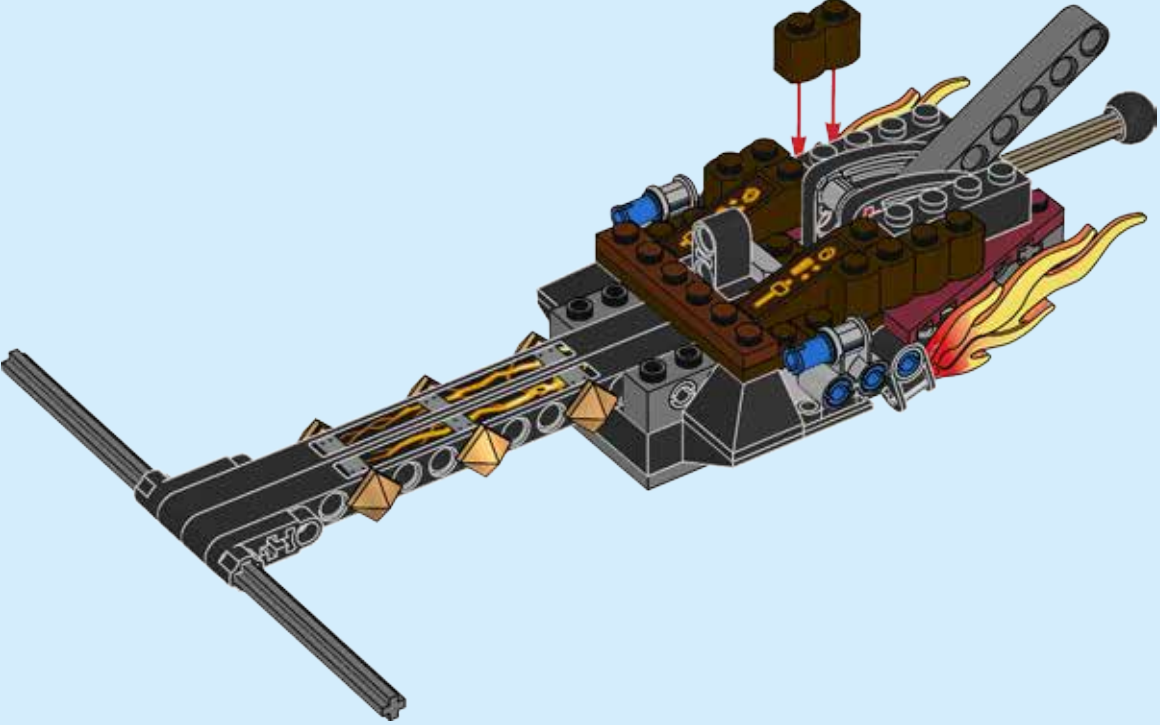



2x

# 35

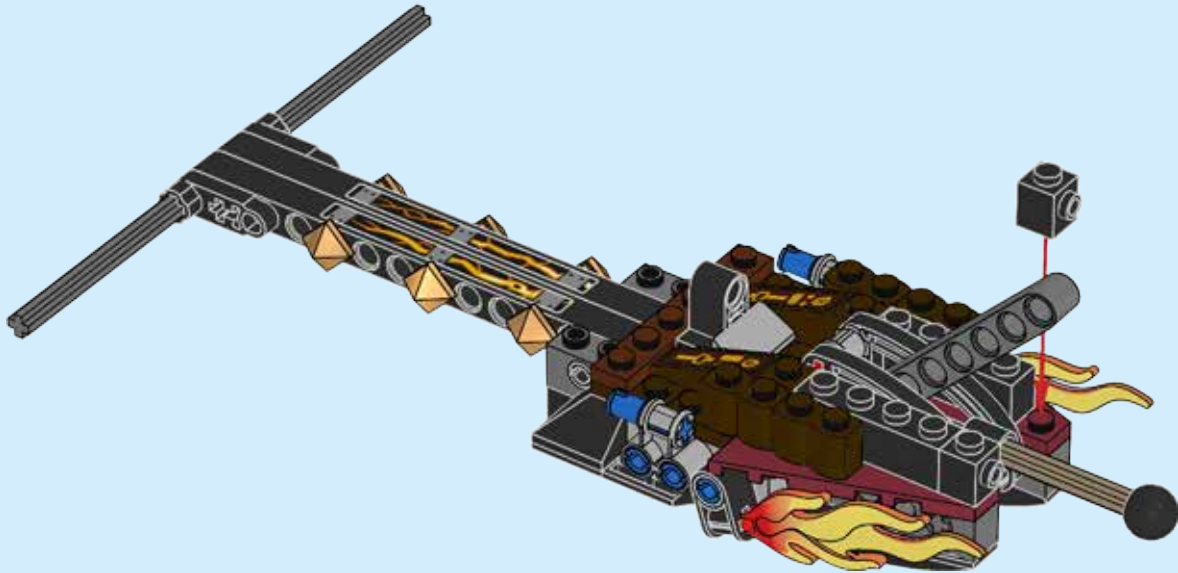
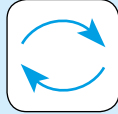



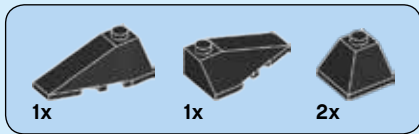

# 36





2x

# 37





# 38

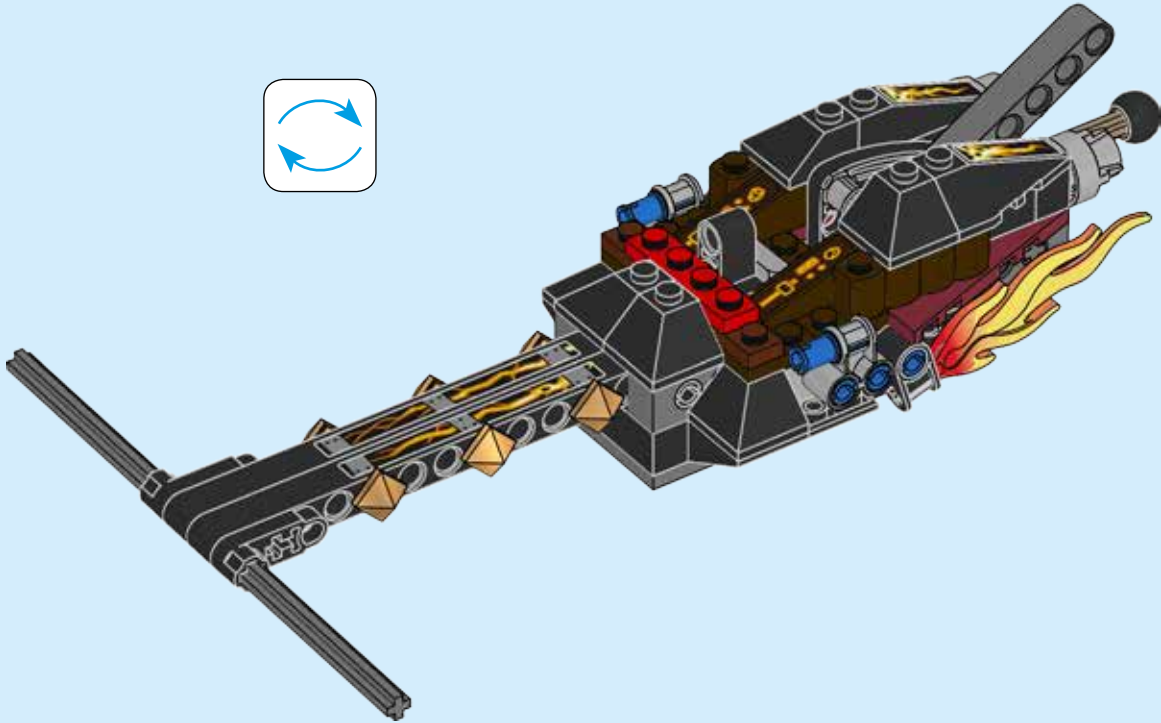
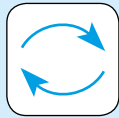



1x



2x

# 39

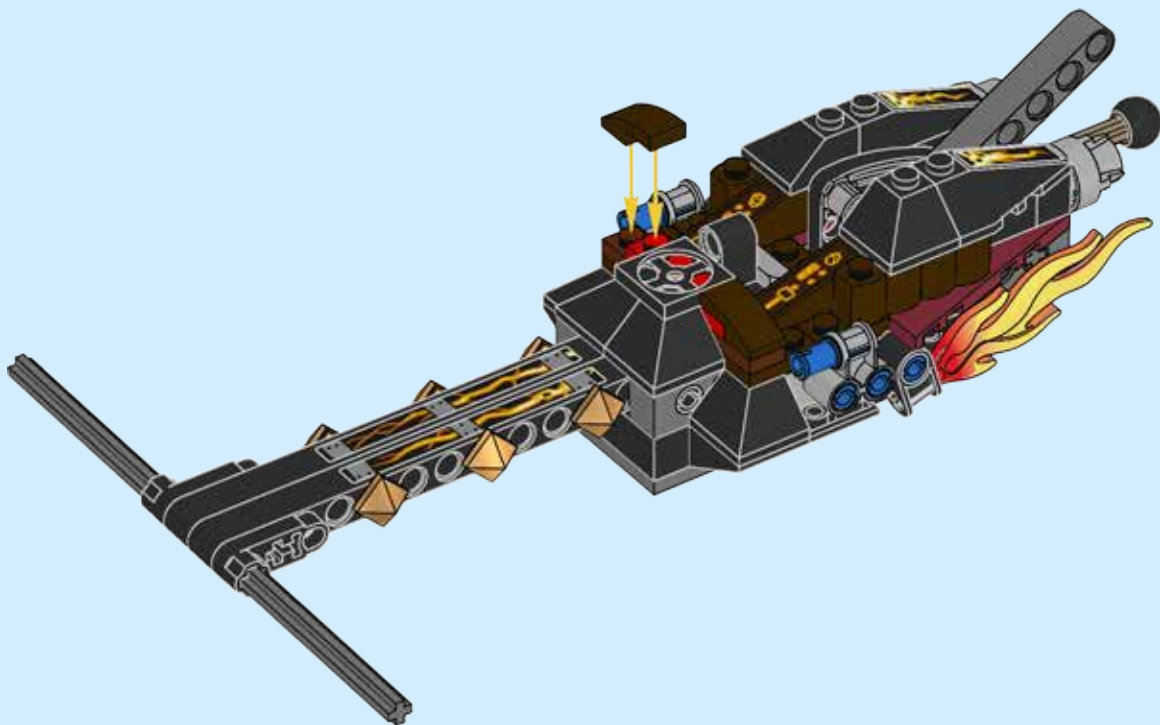



1x

# 40

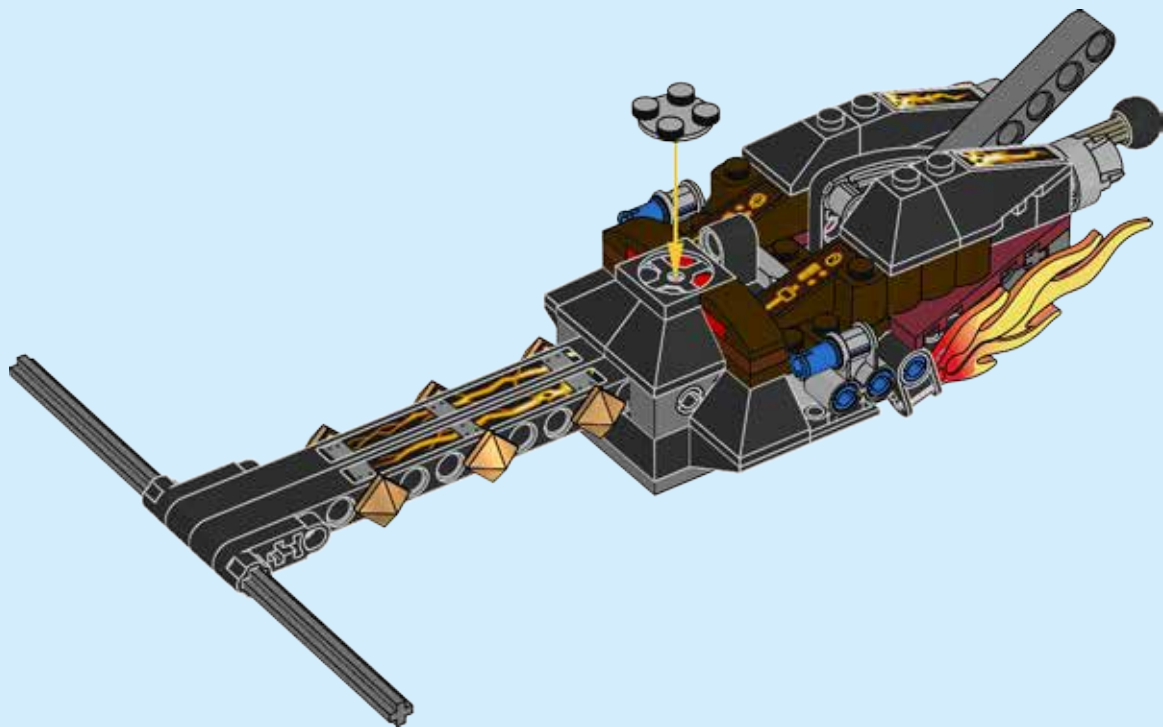



# 41

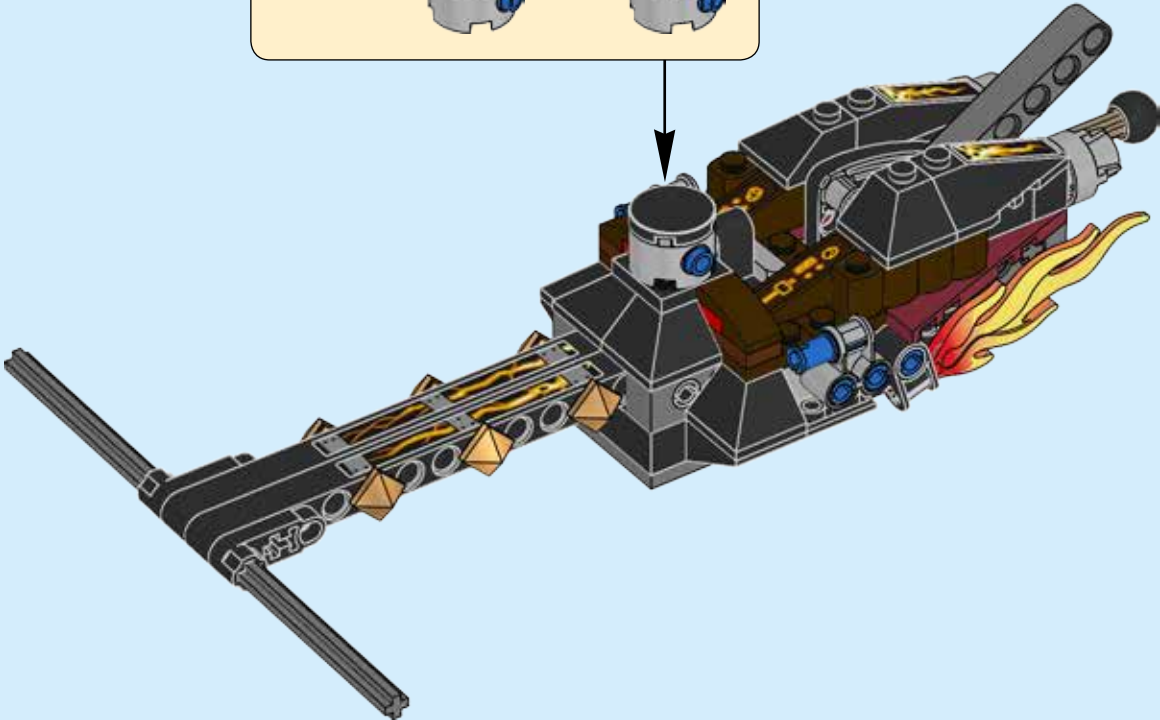
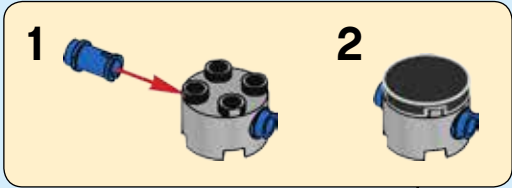



2x

# 42

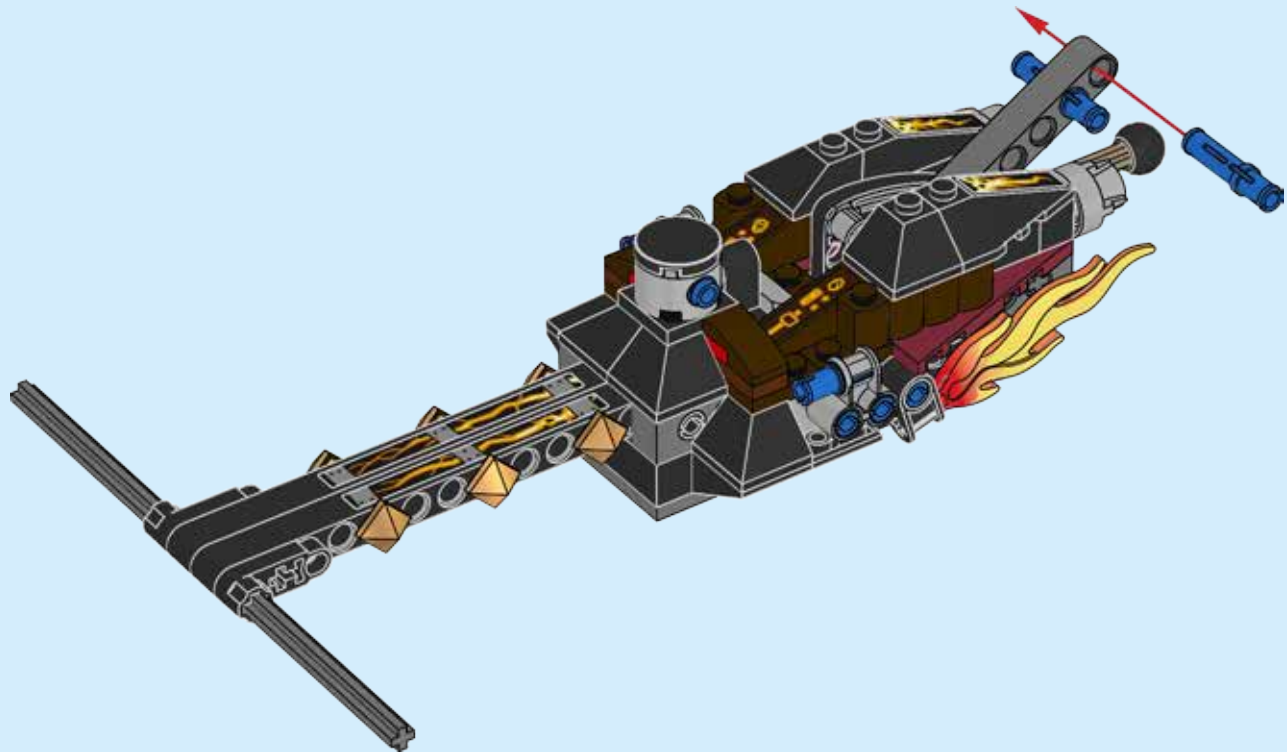

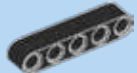

1x

# 43





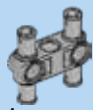

1x

# 44



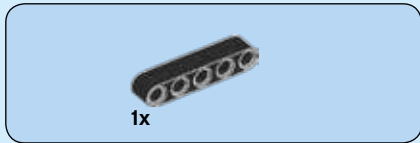

45

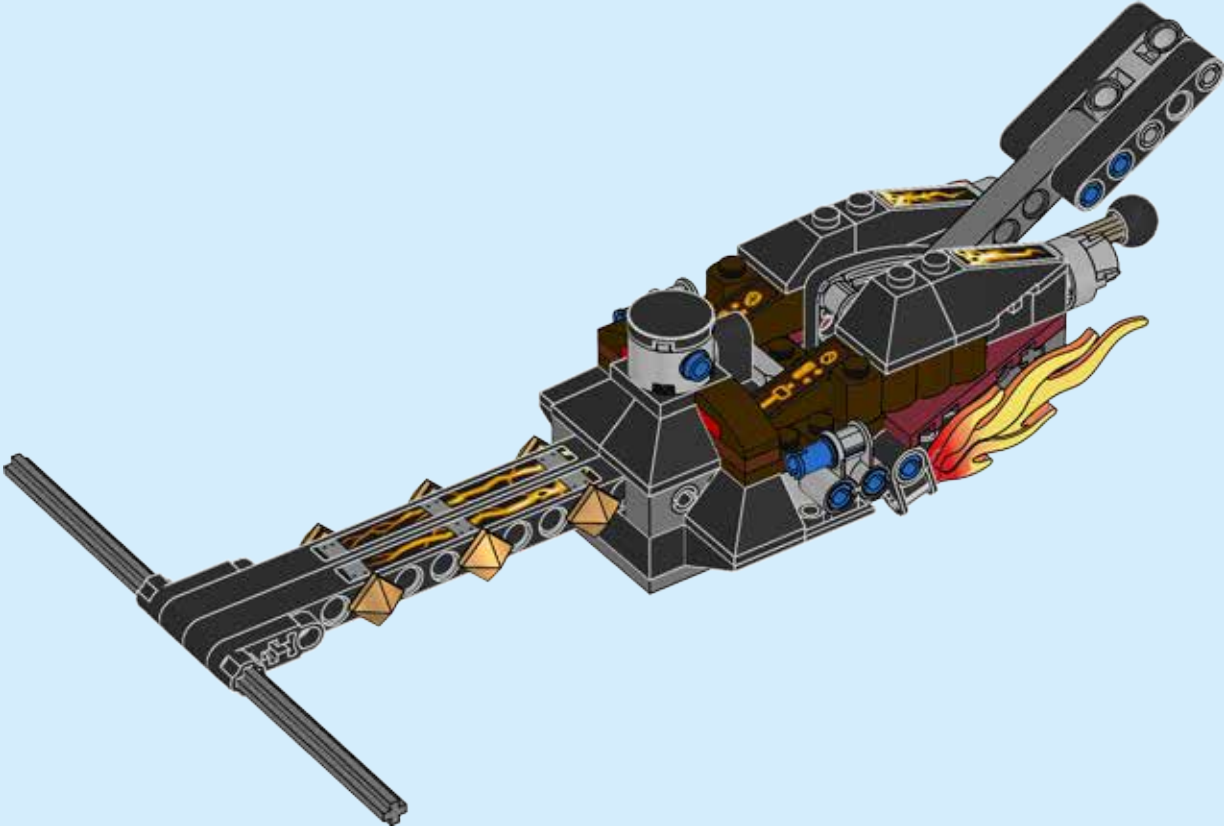

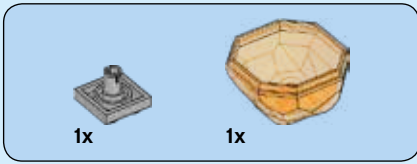

46

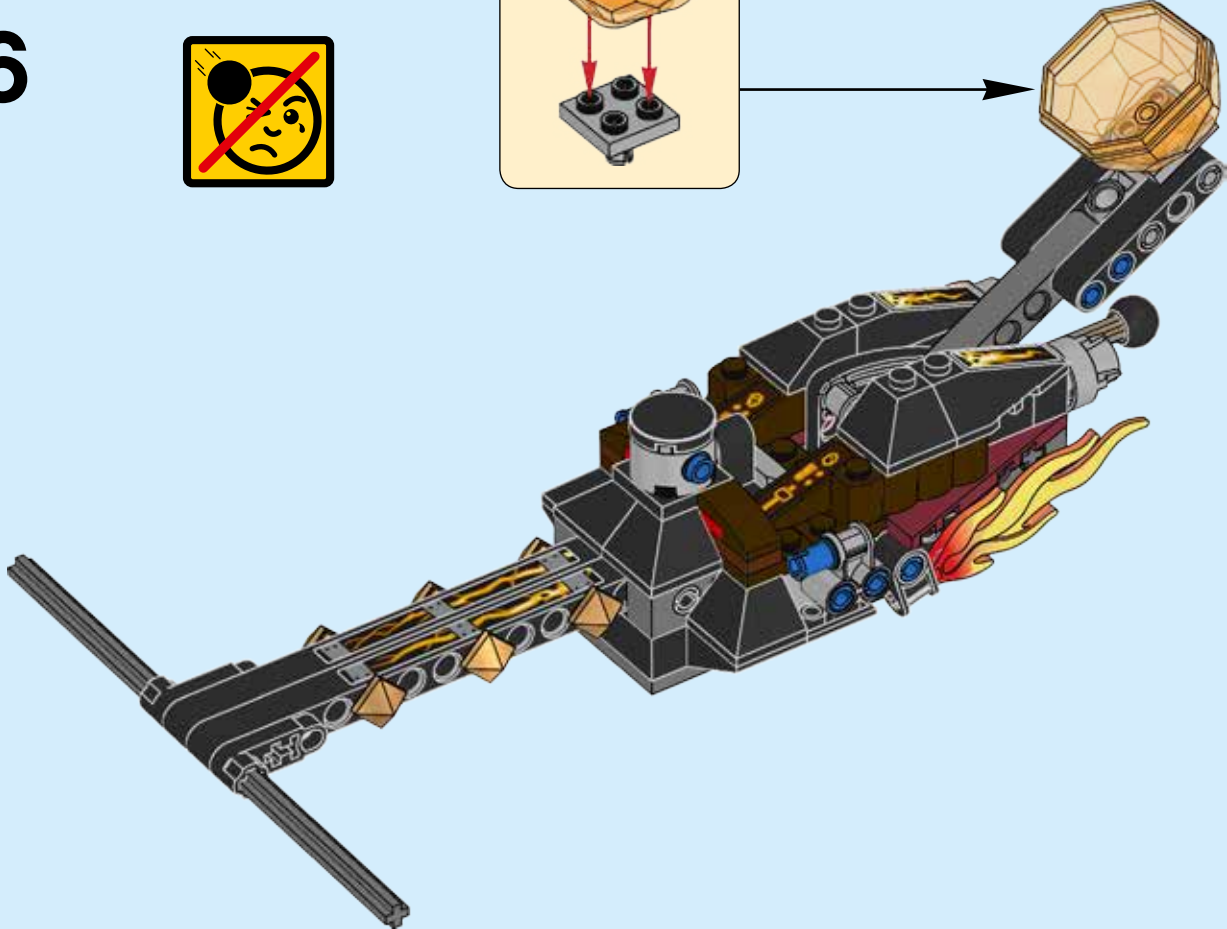
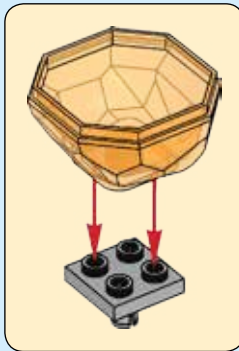



2x



1x



1x

# 47

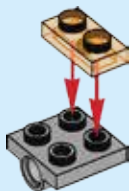

1x

# 48

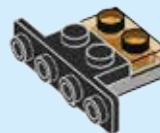



1x

# 49

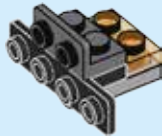

1x

# 50





1x

# 51



1x



1x

# 52

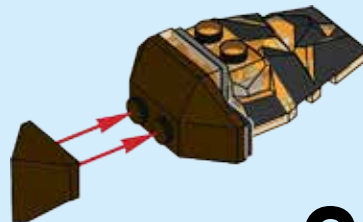

# 2x

53

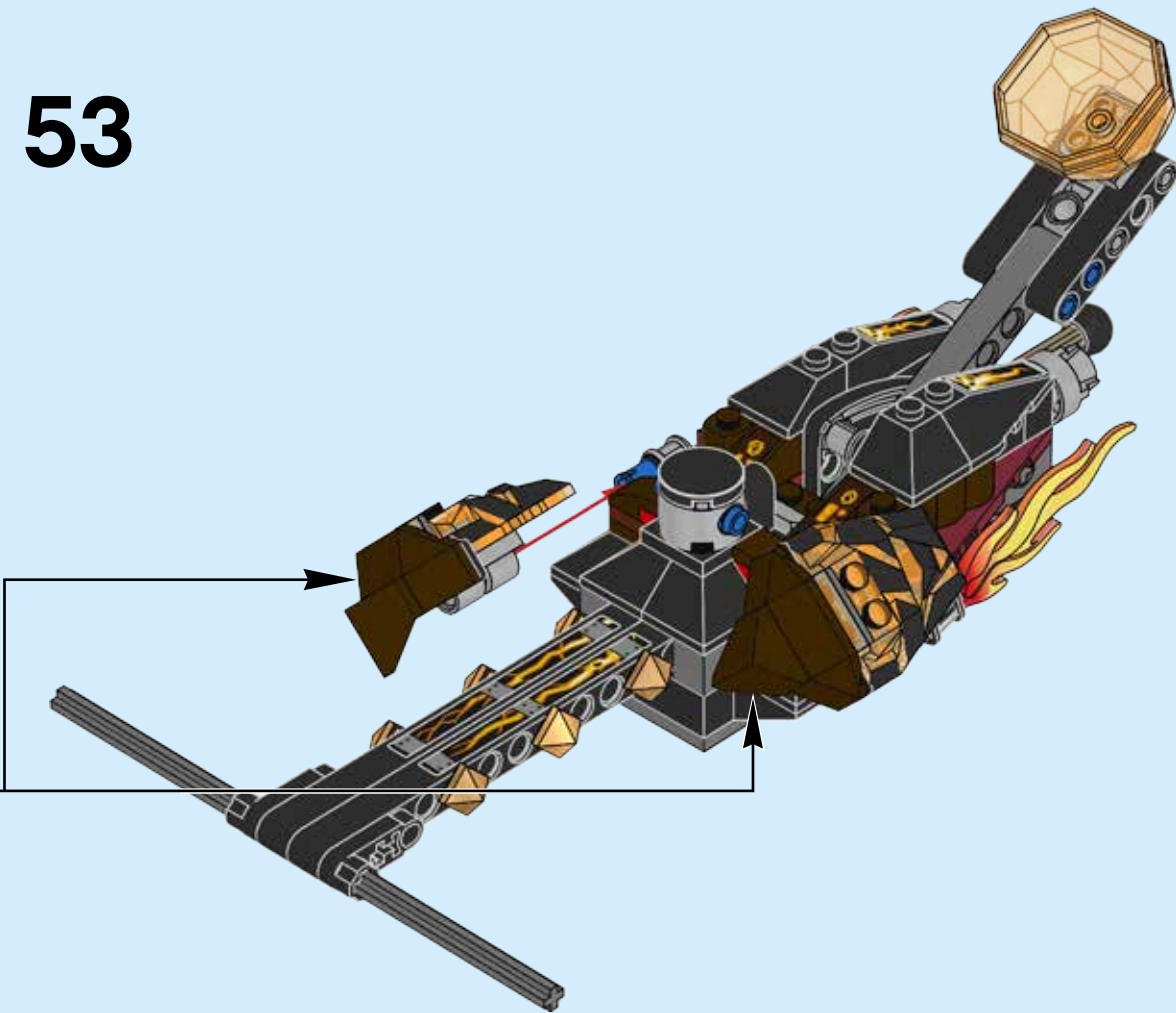



2x

# 54

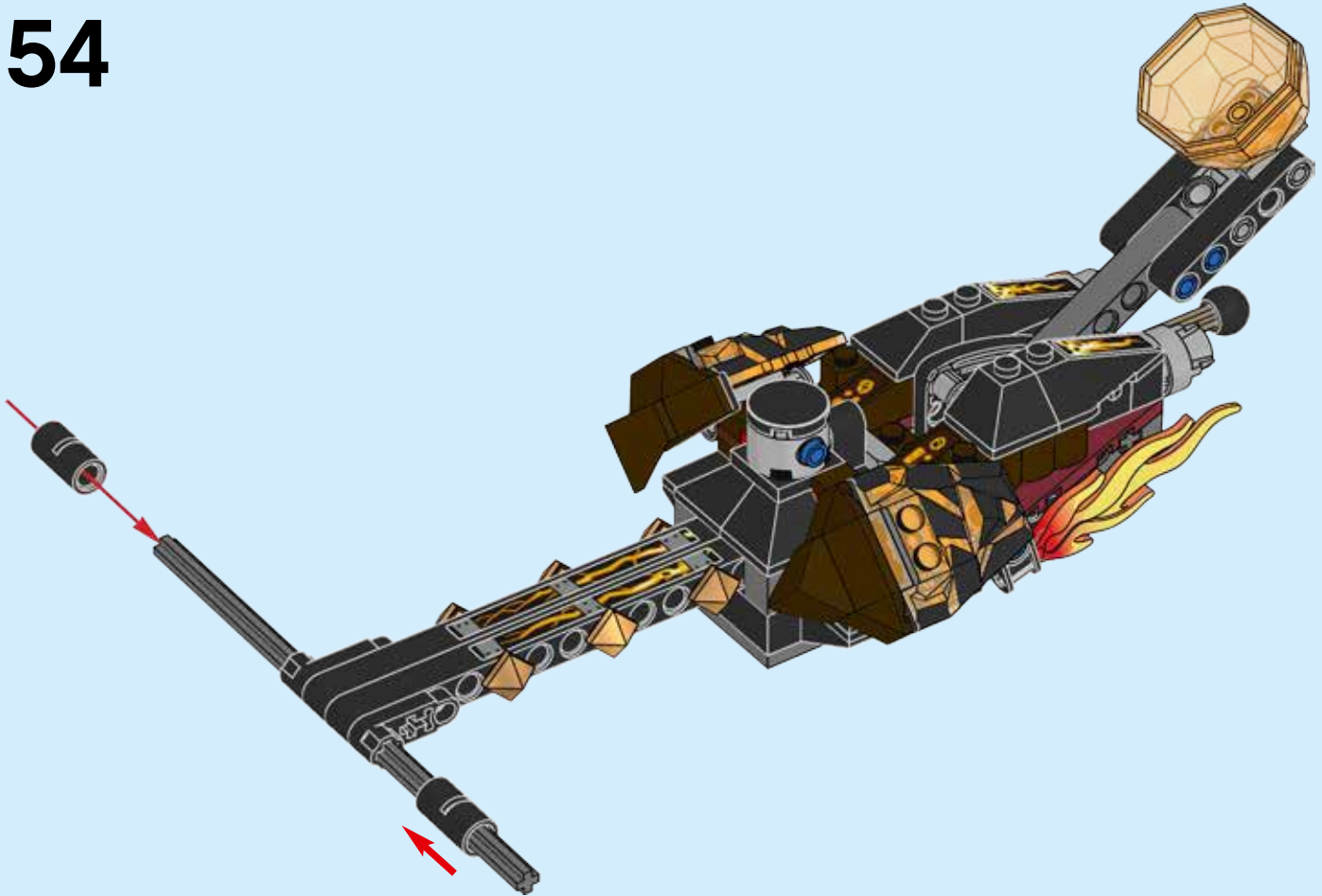





2x

# 55

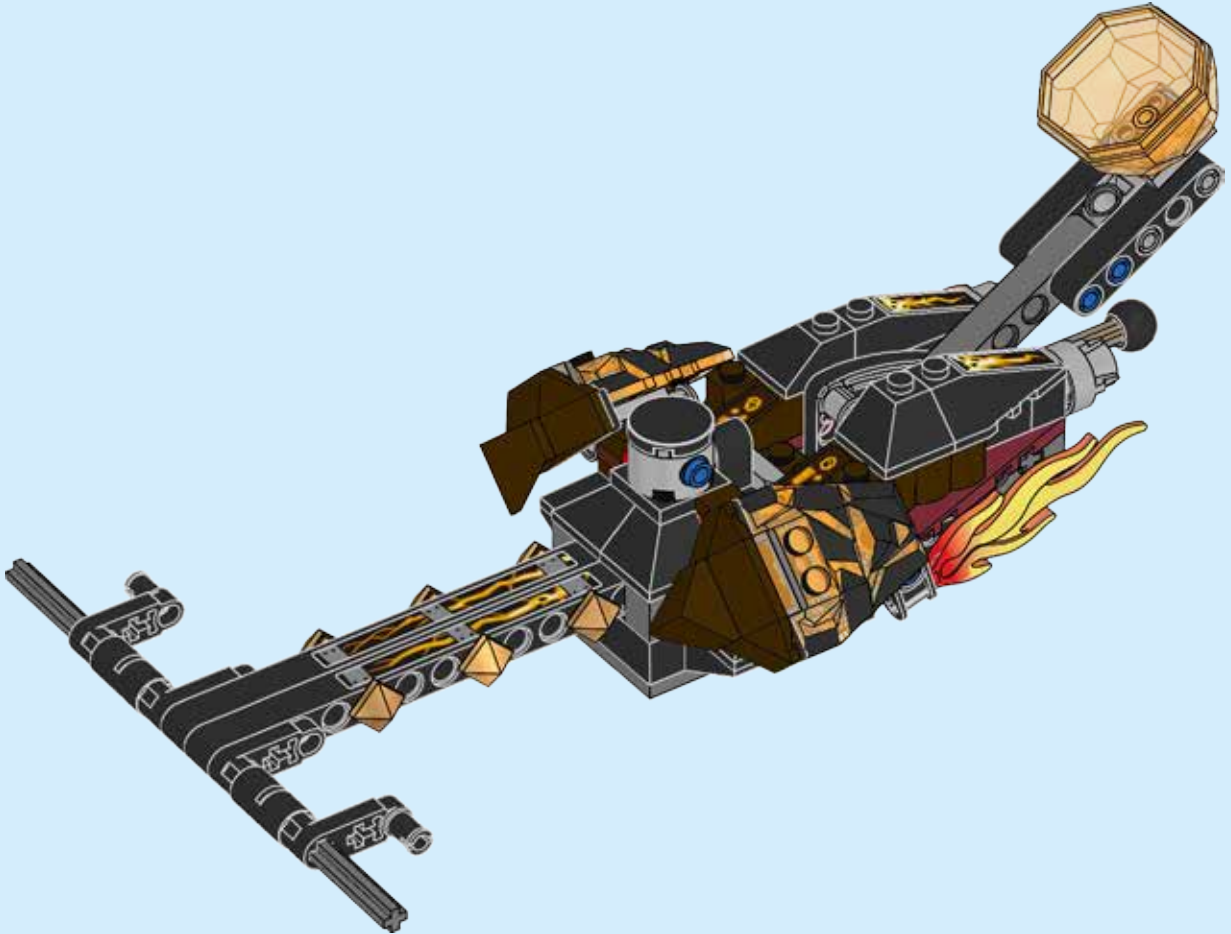

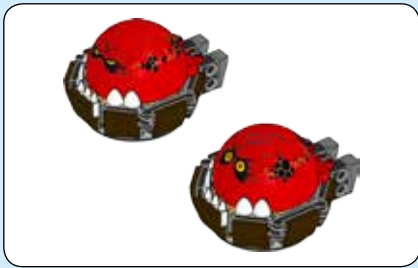

56

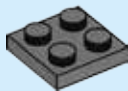

57

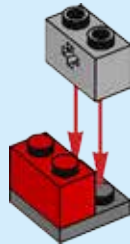

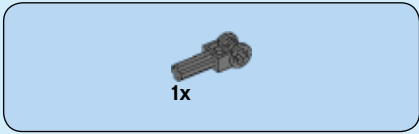

58

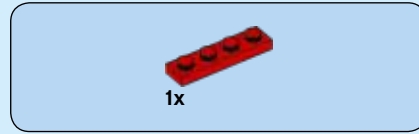
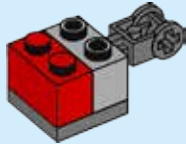

59

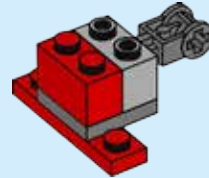



2x

# 60

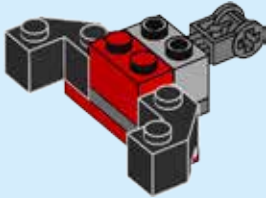

2x

# 61

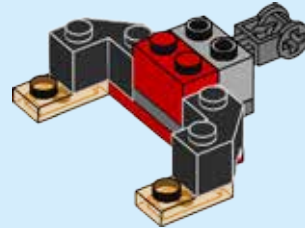



2x

# 62

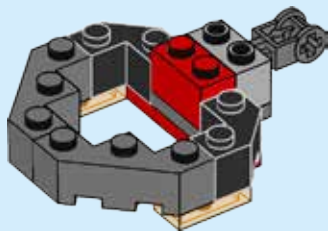

1x

# 63

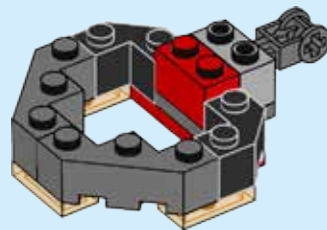



2x

# 64

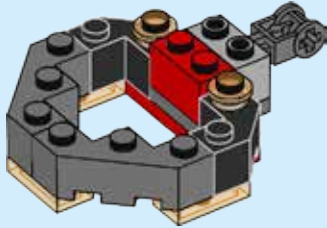

3x

# 65

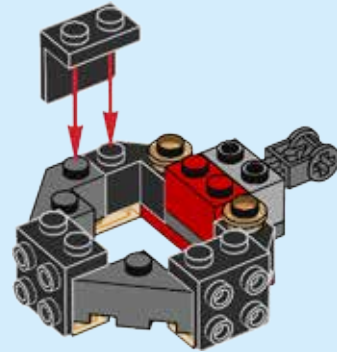

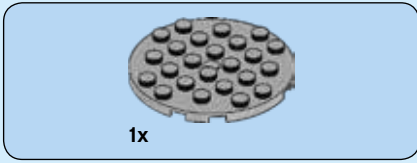

66

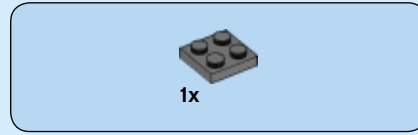
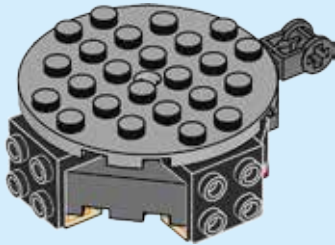

67

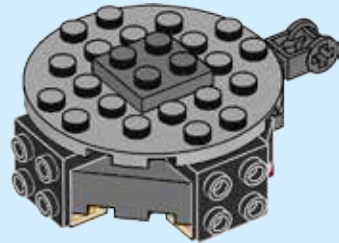

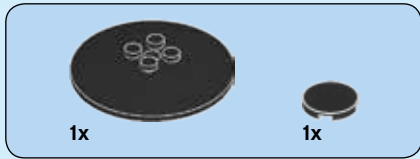

# 68

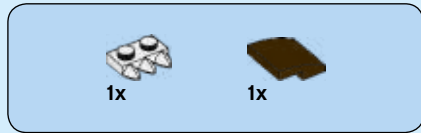
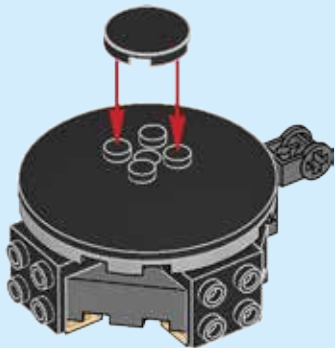

# 69

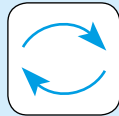



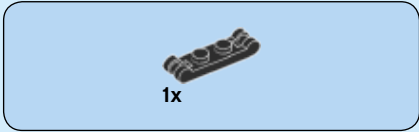
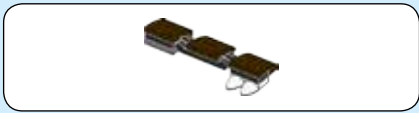

70

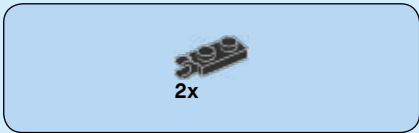

71





3x

# 72

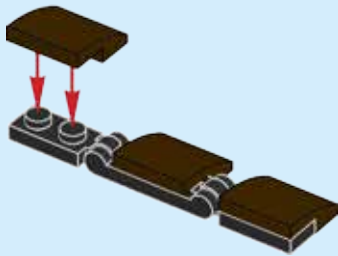

1x



2x

# 73

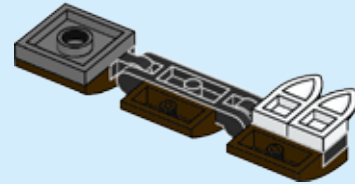
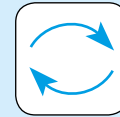

74

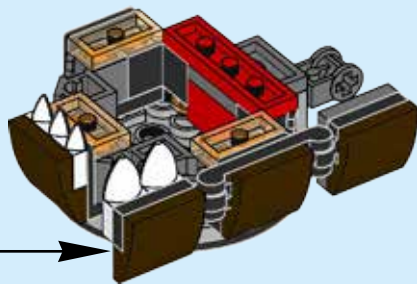



1x

# 75



2x

# 76

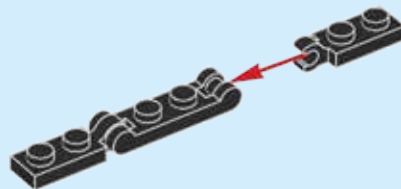



3x

# 77

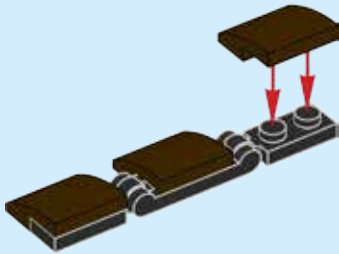

1x



2x

# 78

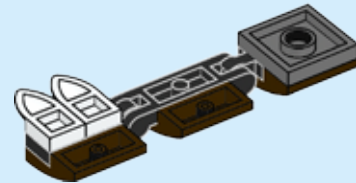
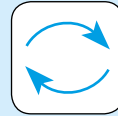

79

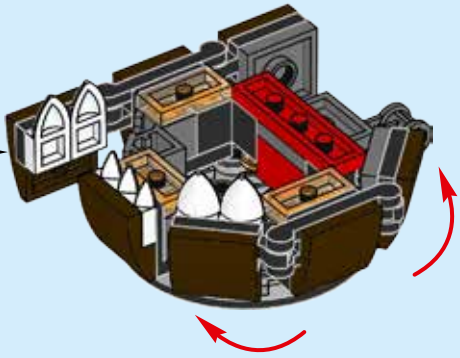

80

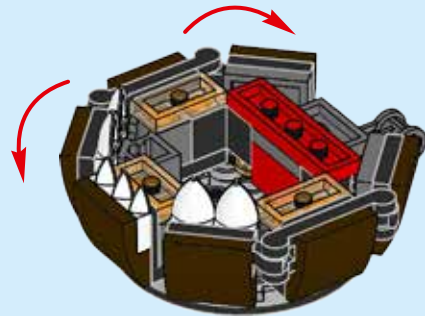

2x

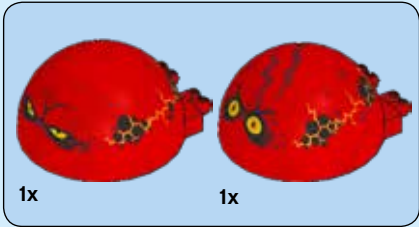
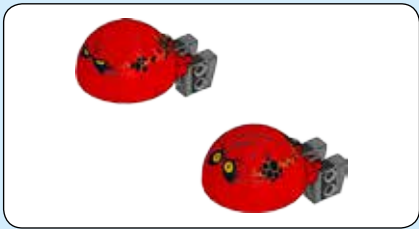

81





4x



4x



4x

# 82

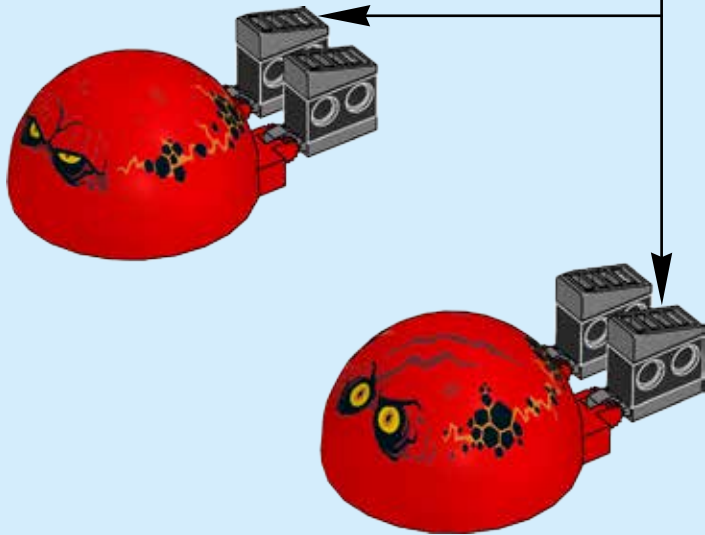
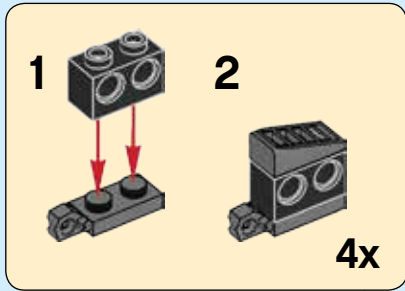

# 83

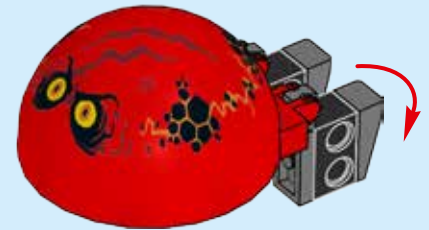
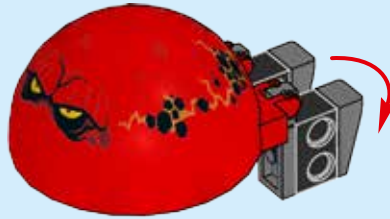



84

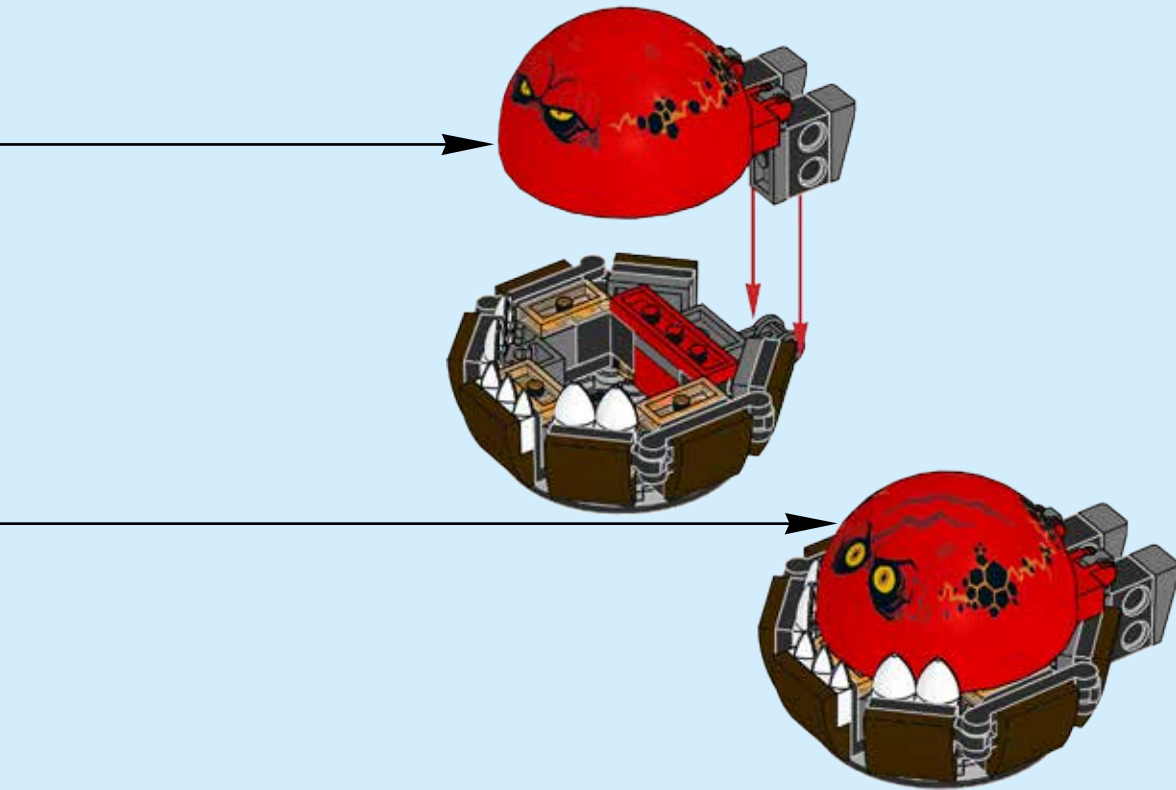

85

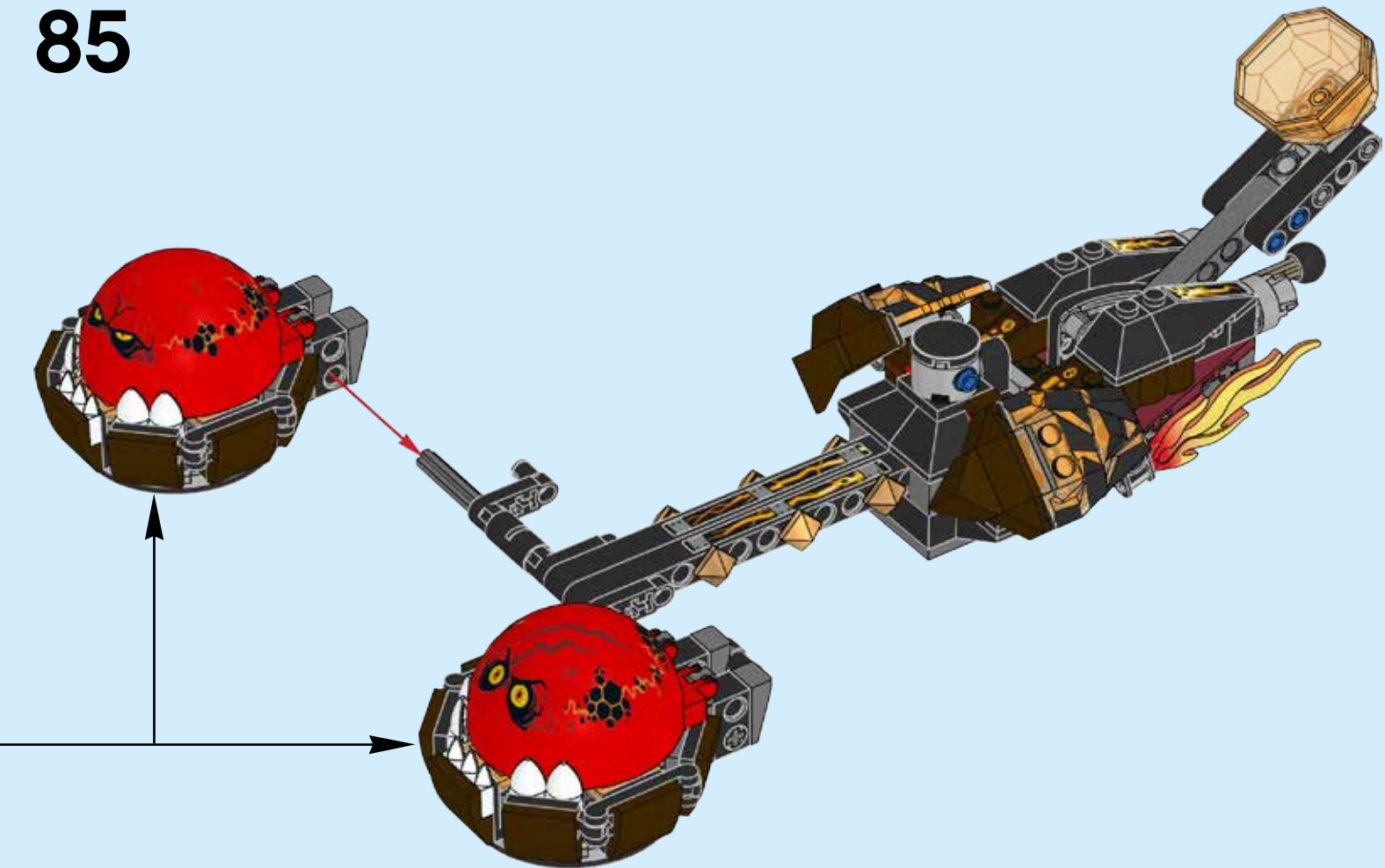

2x

# 86

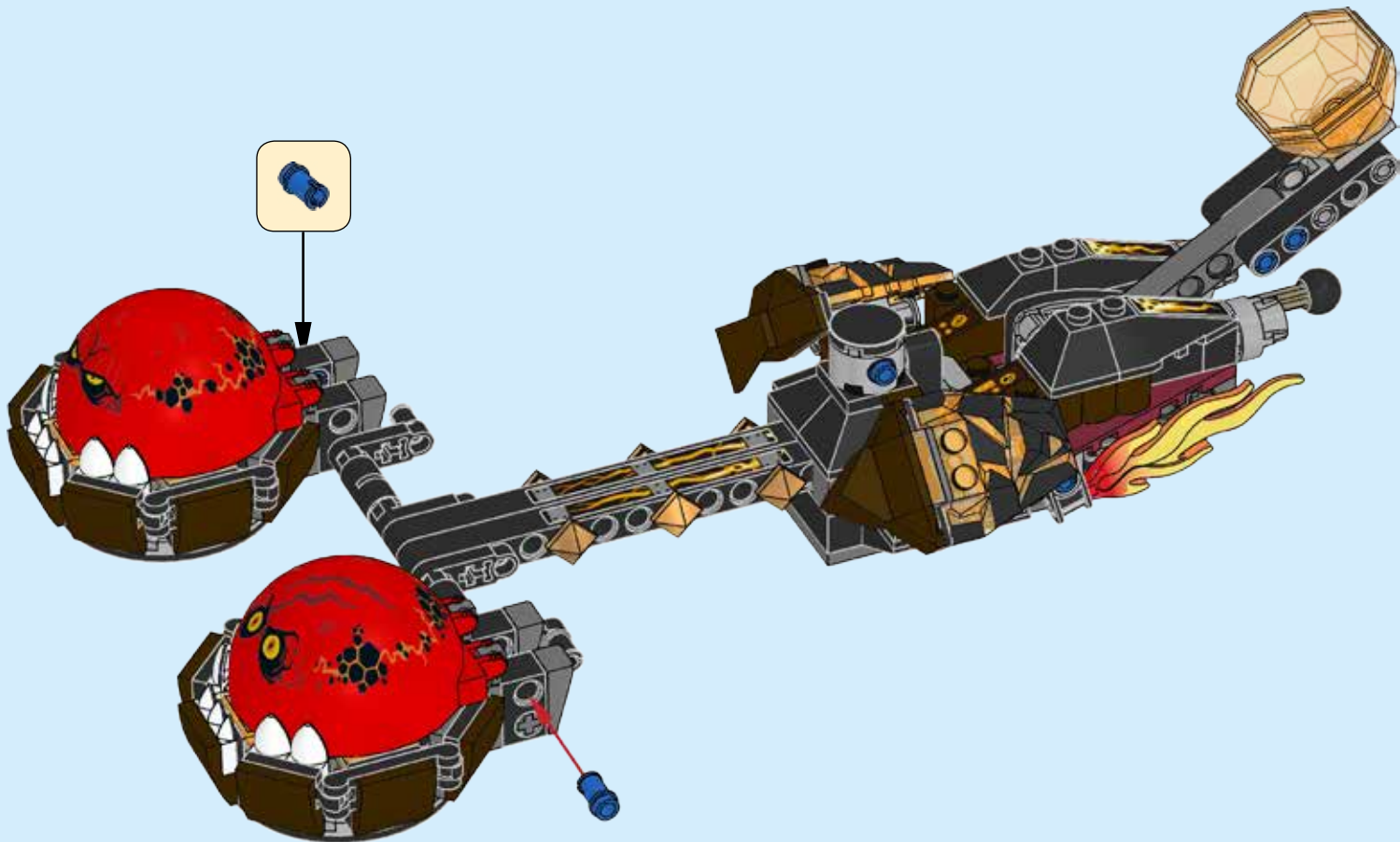

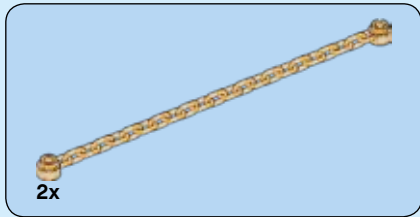

87

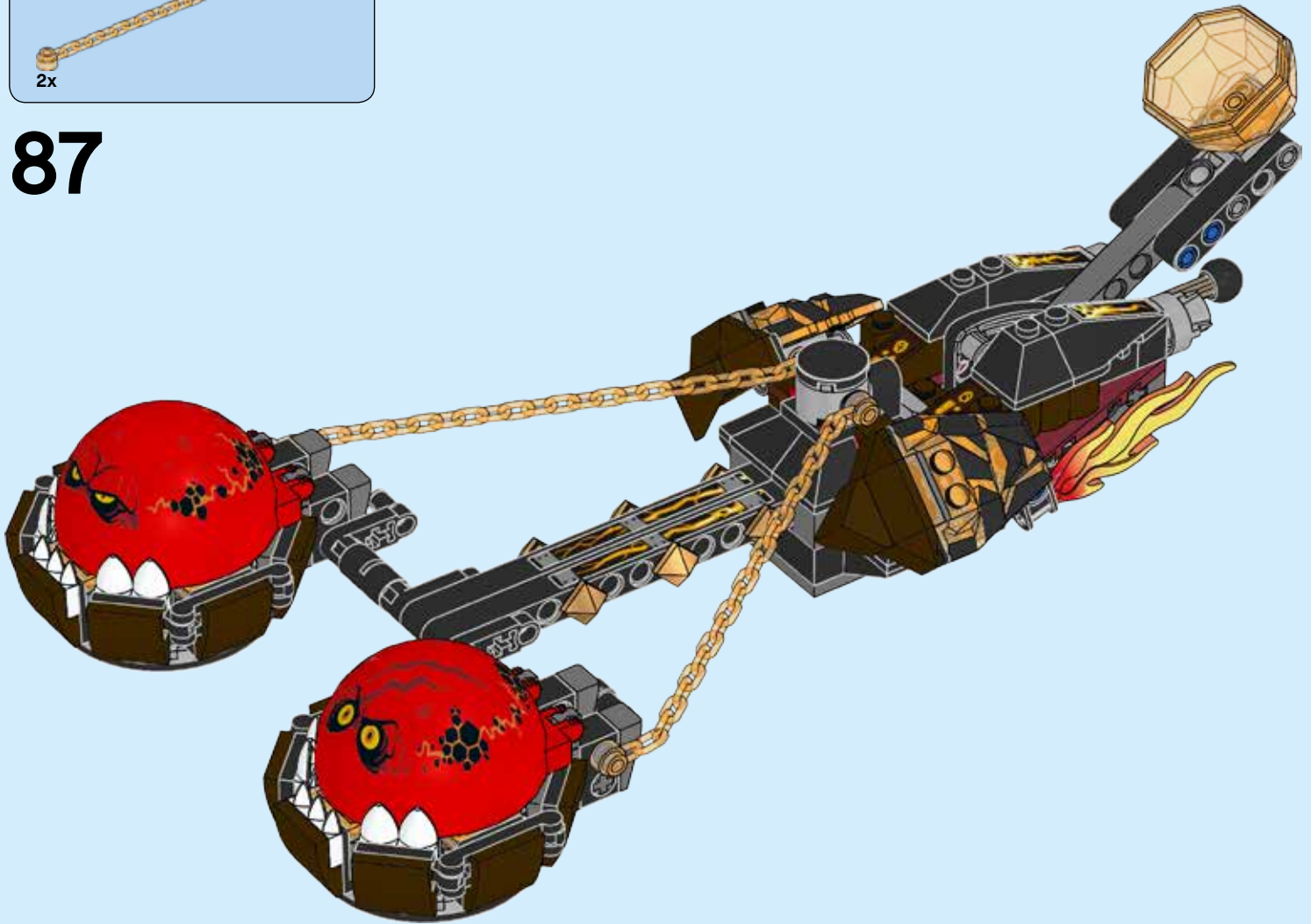

1x 1x 2x



88



89

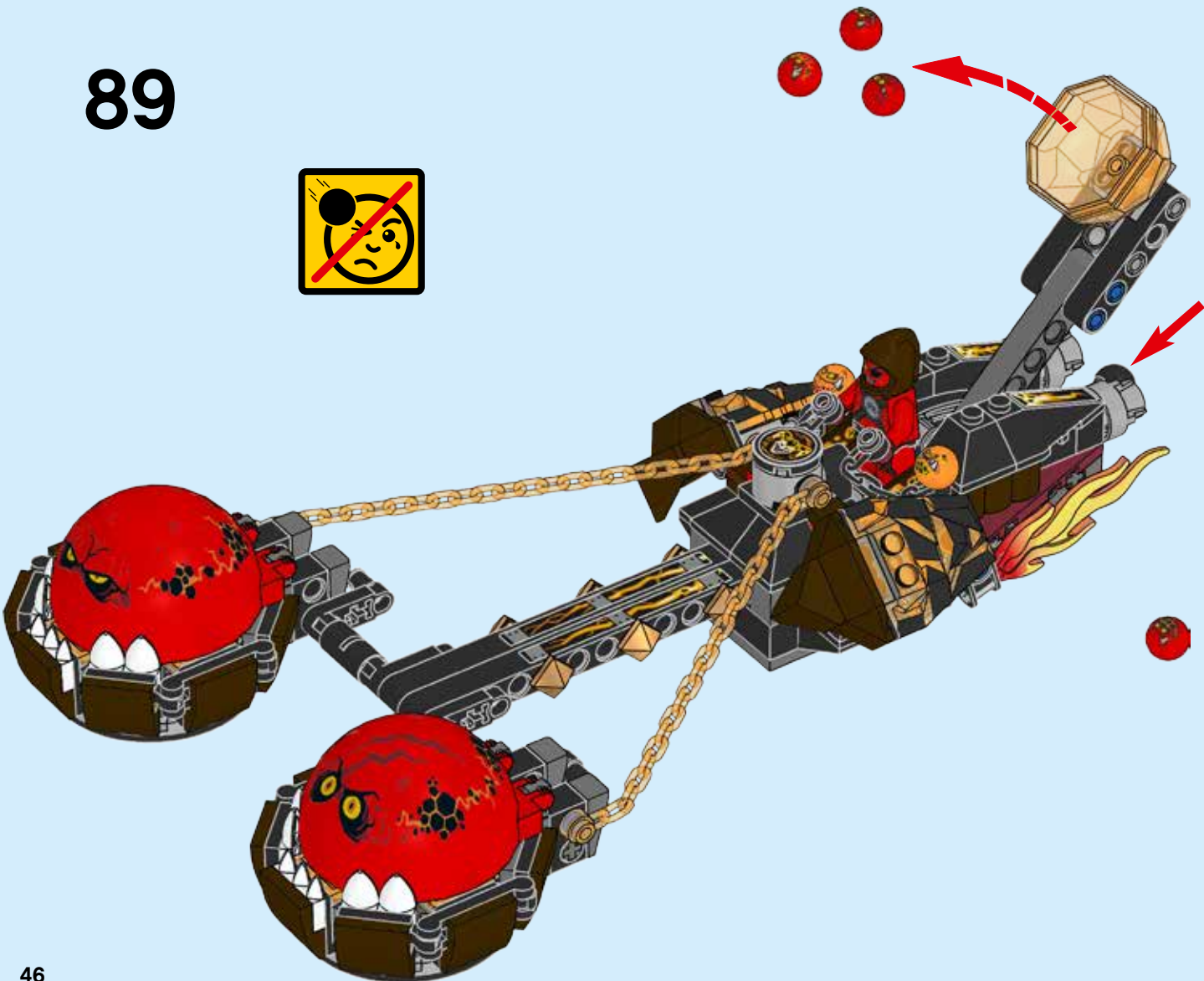

90

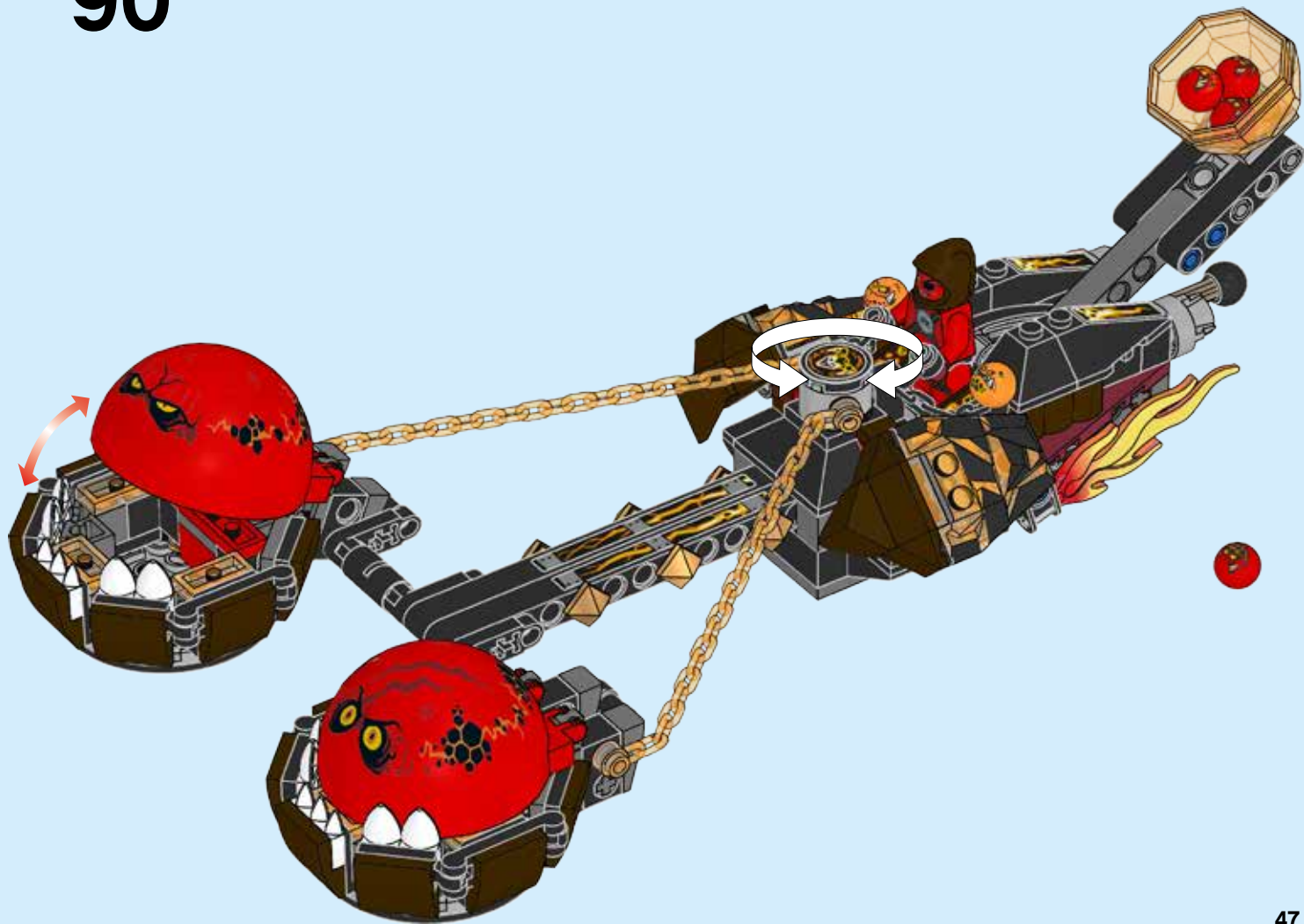

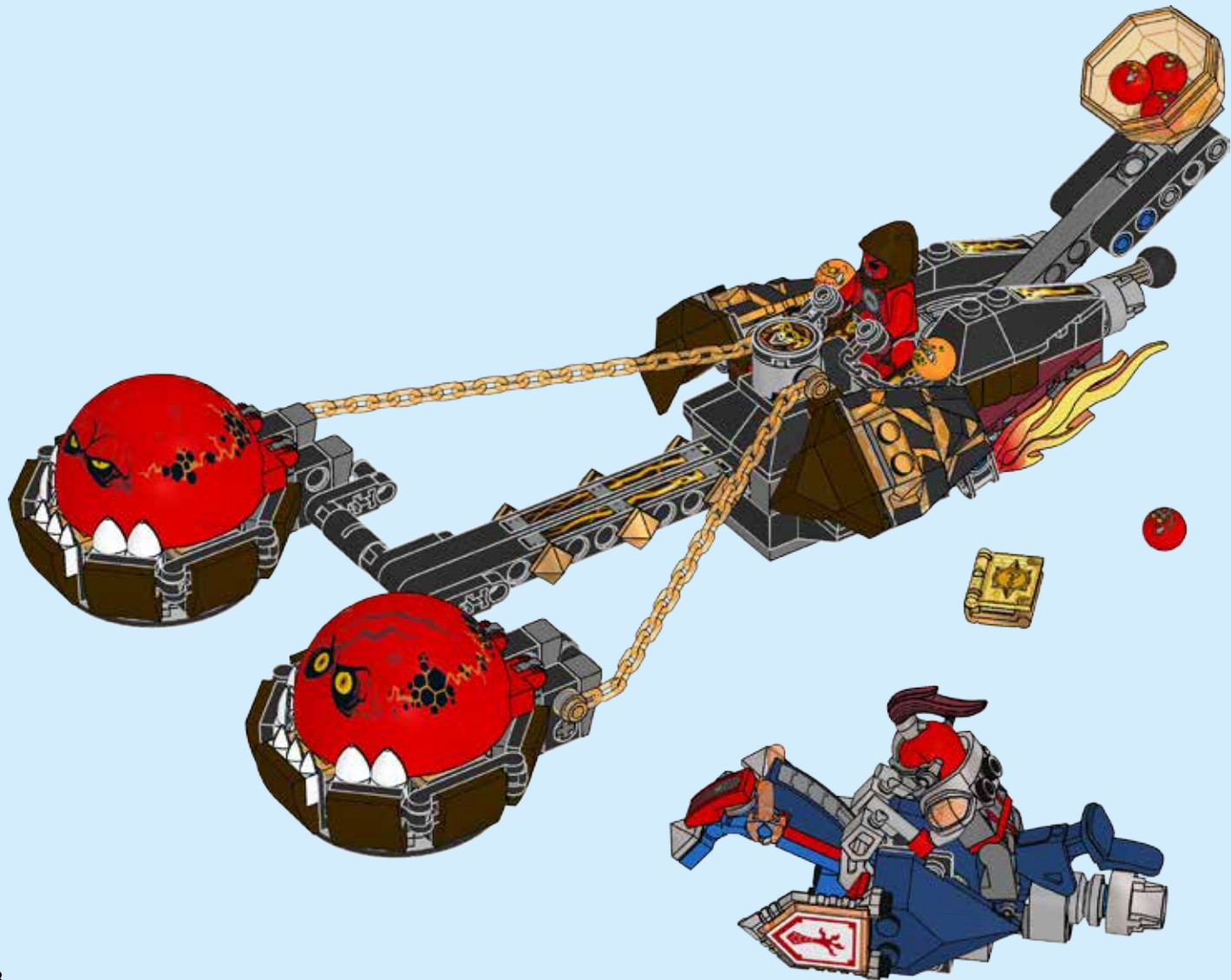





# NEXO KNIGHTS



DOWNLOAD  
THE FREE APP



LEGO® NEXO KNIGHTS™: MERLOK 2.0



1



2



3

DOWNLOAD THE FREE APP / KOSTENLOSE APP HERUNTERLADEN / TÉLÉCHARGE L'APPLI GRATUITE  
DESCARGA LA APP GRATIS / DESCARREGA A APP GRÁTIS / TÖLTSD LE AZ INGYENES APPOT / 下載免費APP  
DEVICE CHECK / GERÄT PRÜFEN / VERIFICATION DE COMPATIBILITE :  
COMPRUEBA TU DISPOSITIVO / VERIFICAÇÃO DO DISPOSITIVO / ESZKÖZZELLENÖRZÉS / 設備檢查

[LEGO.com/devicecheck](http://LEGO.com/devicecheck)



# NEXO KNIGHTS

## SCANNING TIPS

Scanning Tips / Tipps zum Scannen / Conseils de scannage /  
Consejos para escanear / Dicas para o scan /  
Beolvasási tippek / 扫描秘诀





# NEXO KNIGHTS



LEGO  
LEGOLAND  
DISCOVERY CENTER

# LEGOLAND



DOWNLOAD THE FREE APP; KOSTENLOSE APP  
HERUNTERLADEN; TÉLÉCHARGE L'APPLI GRATUITE ;/  
DESCARGA LA APP GRATIS; DESCARREGA A APP GRATIS;/  
TÖLTSD LE AZ INGYENES APPOT!; 下载免费 APP;  
LEGO® NEXO KNIGHTS™: MERLOK 2.0

ALL MATERIALS MIGHT NOT BE  
AVAILABLE IN ALL MARKETS.  
MÖGLICHERWEISE IST NICHT DAS GANZE MATERIAL IN ALLEN  
MÄRKTEN VERFÜGBAR; CERTAINS PRODUITS PEUVENT NE  
PAS ÊTRE DISPONIBLES SUR CERTAINS MARCHÉS; CIERTOS  
MATERIALES PODRÍAN NO ESTAR DISPONIBLES EN TODOS  
LOS MERCADOS; OS MATERIAIS PODERÃO NÃO ESTAR TODOS  
DISPONÍVEIS EM TODOS OS MERCADOS; ELKÉPZELHETŐ,  
HOGY BIZONYOS KIEGÉSZÍTŐK A TE ORSZÁGODBAN NEM  
ELÉRHETŐEK; /部分内容可能不适用于某些国家/地区

LEGO.COM/NEXOKNIGHTS

**LEGO**

# NEXO KNIGHTS





 6x  
6129416

 1x  
6138666

 1x  
4540280

 2x  
6129858

 1x  
6018481

 1x  
6129756

 2x  
6132361

 1x  
6129616

 1x  
6125657

 2x  
4504379

 1x  
4298617

 1x  
4142865

 2x  
4632572

 1x  
6125709

 2x  
300421

 1x  
6029946

 1x  
6117974

 1x  
4534648

 1x  
6124855

 2x  
300221

 3x  
371021

 1x  
6132202

 1x  
6132205

 1x  
4290713

 2x  
4558954

 1x  
473326

 3x  
6070695

 3x  
4173668

 6x  
4121715

 2x  
4526982

 1x  
4144024

 4x  
3200026

 2x  
366526

 4x  
6000650

 2x  
4542573

 6x  
6117973

 4x  
4563044

 8x  
4535739

 1x  
368026

 6x  
4189064

 2x  
6089577

 4x  
6099483

 5x  
374726

 3x  
301026

 4x  
4584274

 1x  
6040298

 2x  
4128557

 1x  
6040297

 2x  
4142135

 2x  
6062698

 1x  
4161266

 2x  
6058341

 1x  
4161281

 1x  
6133120

 1x  
6134219

 1x  
4539068

 1x  
4539069

 1x  
6125685

 4x  
4222960

 10x  
4280341

 1x  
6120912

 2x  
6132333

 2x  
6132438



**Customer Service**  
**Kundenservice**  
**Service Consommateurs**  
**Servicio Al Consumidor**  
**LEGO.com/service or dial**

**: 00800 5346 5555**  
**: 1-800-422-5346**