



# Architecture

21030

## United States Capitol Building

Washington, D.C., USA



## The United States Capitol Building

The United States Capitol in Washington, D.C. is a symbol of American democracy and the meeting place of the nation's government. As well as housing an important collection of American art and being an architectural achievement in its own right, the Capitol is still a working office building and a

tourist attraction visited by millions every year. The building has been at the heart of the country's history since it was first completed in 1800.

*[ We have built no temple but the Capitol.  
We consult no common oracle but the Constitution ]*

Rufus Choate, Congressman & Orator





## History

On September 18, 1793, President George Washington laid the cornerstone of the U.S. Capitol Building at the southeast corner of its foundation. The ceremony was carried out with great pomp and celebration as it marked the building of the young nation's most symbolically important and architecturally impressive building.

The building was to be the centerpiece in the creation of Washington, D.C. as the nation's new capital. Pierre Charles L'Enfant, who created the plan of the city, selected the site and laid out the wide boulevard leading up to it, but was dismissed before he could draw the building itself.

In the democratic spirit that the building represented, the then U.S. Secretary of State Thomas Jefferson announced a public competition to design the new Capitol Building.

An idea submitted by the amateur architect William Thornton was selected and received praise from President Washington for its "Grandeur, Simplicity and Beauty". Three renowned architects of the time, Stephen Hallet, George Hadfield and the designer of the White House, James Hoban, were asked to realize Thornton's plan. After seven years and many changes to Thornton's original drawings, the first stage was completed in 1800.

After being partially burned down by the British in 1814, the U.S. Capitol Building was rebuilt and the first dome at the center of the building was added in 1818. By the 1850s it was clear that the building could no longer accommodate the growing number of states joining the union and the Capitol was expanded to become the building we recognize today.



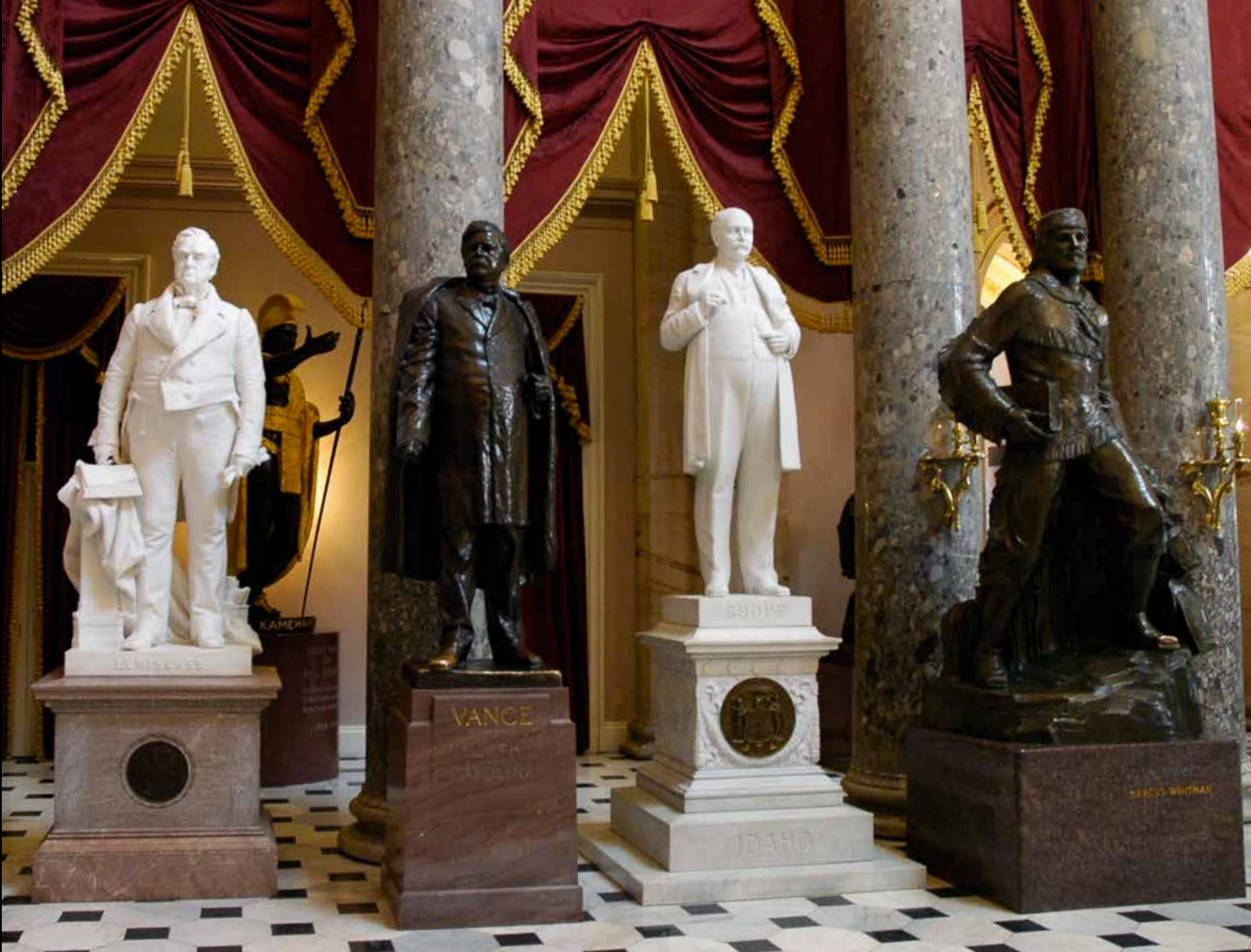

LEWIS CASS



VANCE



SHREVE



HARBO WHITMAN



## The United States Capitol Building Today

The U.S. Capitol Building continues to be the working heart of the nation's government and the 435 Representatives and 100 Senators still sit in the two houses of Congress within the building. Here they debate legislation, hold hearings and conduct investigations as the voice of the American people.

But the U.S. Capitol Building is also an attraction in its own right and houses some of the nation's greatest art treasures. The heart of the Capitol is the rotunda, a 96 ft. (29 m) diameter circular hall crowned by an inner dome. Visible through the eye of the dome, 180 ft. (55 m) above the floor is a massive fresco painted by Italian artist Constantino Brumidi. The 4,664 sq. ft. (433 m<sup>2</sup>) mural, entitled The Apotheosis of George Washington, consists of a portrait of the nation's first president rising to the heavens. Brumidi also designed the frieze at the top of the walls below the rotunda depicting famous events and people in American

history. Eleven statues currently encircle the rotunda and include former U.S. Presidents such as George Washington, Abraham Lincoln and Dwight D. Eisenhower.

To accommodate the ever-increasing number of visitors to the U.S. Capitol Building, a new Visitor Center was opened in 2008. At nearly 580,000 sq. ft. (54,000 m<sup>2</sup>), the Visitor Center was the largest project in the Capitol's more than two-century history and is approximately three quarters the size of the Capitol itself. The entire facility is located underground on the east side of the Capitol so as not to detract from the building's appearance.

*[ Here, sir, the people govern ]*

Alexander Hamilton



## The Architects

The U.S. Capitol Building has become a landmark of 19th century neoclassical architecture, but the history behind its design and construction is full of controversy and drama.

The amateur architect William Thornton (1759-1828) was born in the British West Indies and became an American citizen in 1787 after completing a medical degree in Scotland. While his design for the Capitol won him praise from the President (as well as \$500 and a building lot in the city), the professional architects employed to oversee the construction were less impressed and tried to alter his design at every turn.

Stephen Hallet (1755-1825) was a professionally trained architect from France. He arrived in the U.S. around 1790 and submitted at least five designs of his own for the Capitol building. Placed in charge of the construction process in 1793, Hallet revised the floor plan of the two wings before being dismissed a year later for insubordination.

The English born architect George Hadfield (1763-1826) took over from Hallet and straightaway suggested major alterations to the original plan. Before his dismissal in 1798, he designed the first office buildings for the cabinet departments.

James Hoban (1758-1831) had supervised both Hallet and Hadfield and now took over the day-to-day supervision. Born in Ireland, he had moved to the U.S. in 1785 after studying architecture in Dublin. Hoban supervised the completion of the north wing and designed its interior, while also overseeing the building of the White House.

The 1850 expansion of the U.S. Capitol was carried out by the American architect Thomas U. Walter (1804-1887). The construction of his two new wings more than doubled the length of the Capitol. As the original dome of 1818 no longer matched the bigger building, Walter replaced it with the larger dome that still stands today.

*[ ...the Capitol "ought to be upon a scale far superior to anything in this Country" ]*

George Washington to Thomas Jefferson, 1792





# Facts about the United States Capitol Building

Location: ..... Washington, D.C., USA

Construction Periods: 1793, 1815, 1850, and 2000

Architectural Style: ..... 19th century Neo-Classical

Dimensions: ..... 751 ft. (229 m) by 350 ft. (106 m)

Height: ..... 288 ft. (87 m)

Building Footprint: ..... 175,170 sq. ft. (16,258 m<sup>2</sup>)



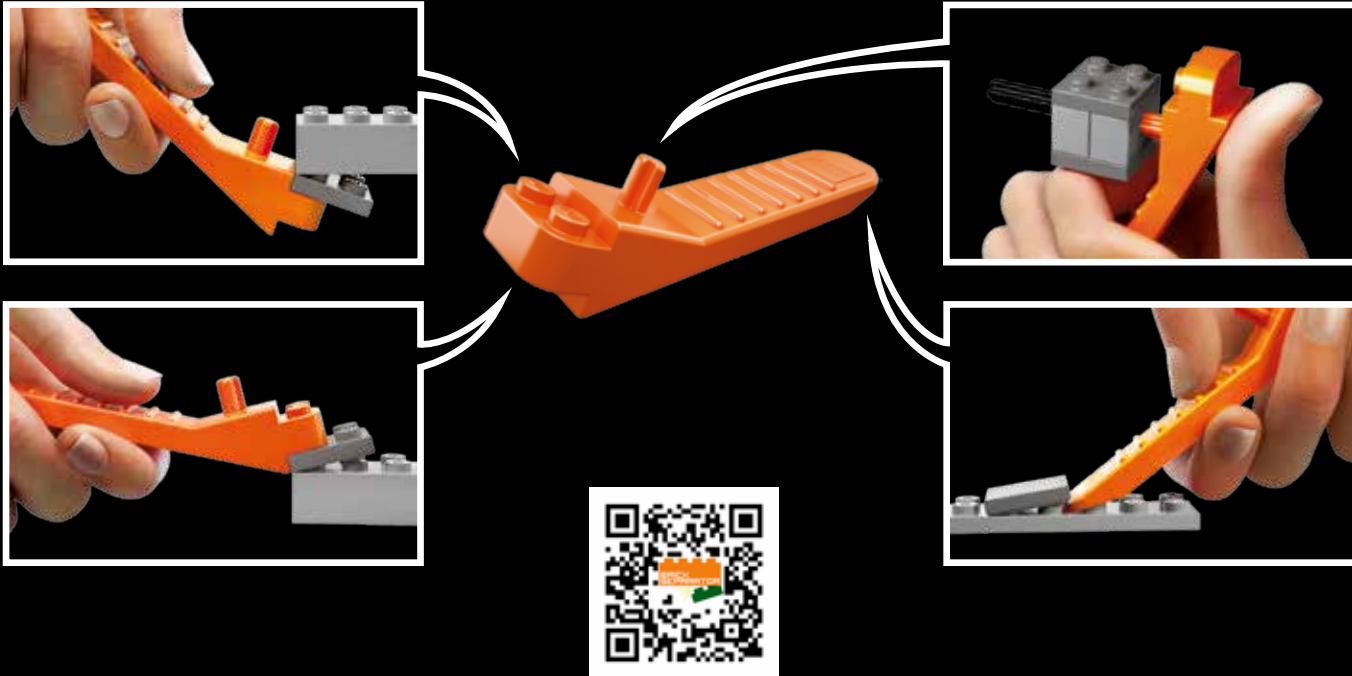

[LEGO.com/brickseparator](https://LEGO.com/brickseparator)

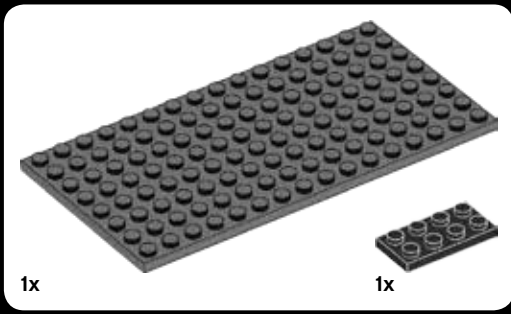

1

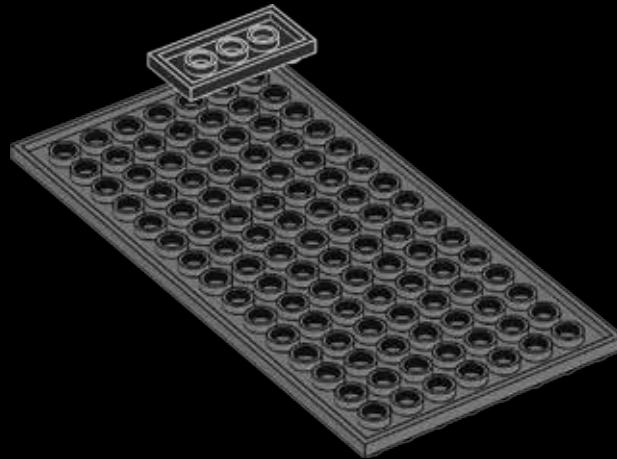

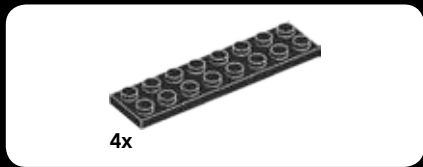

2

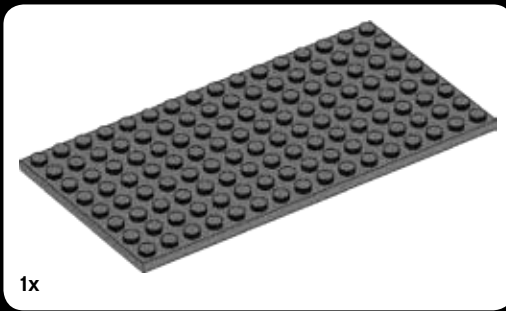
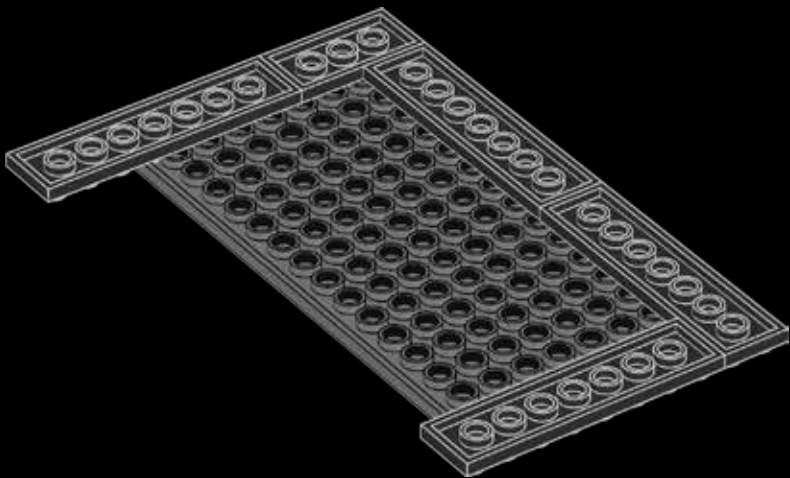

3

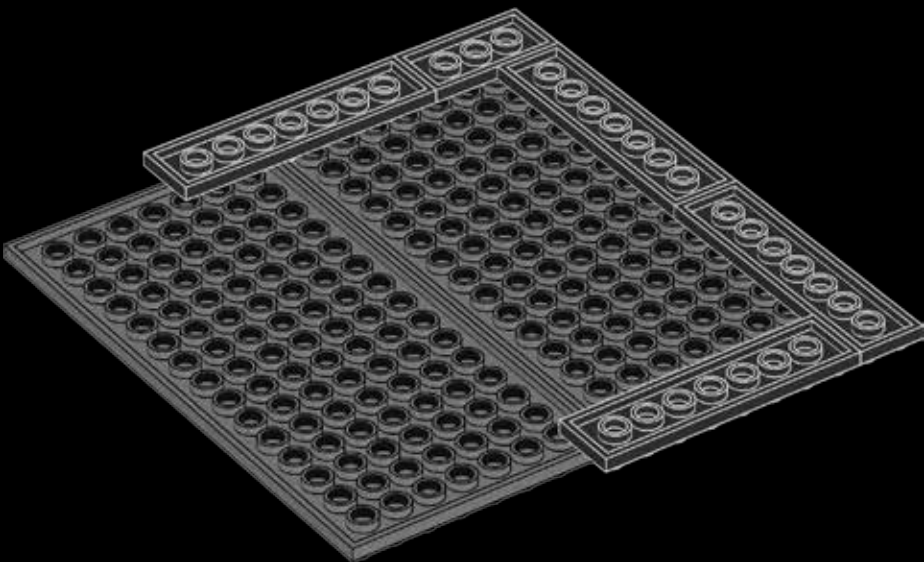



2x

4

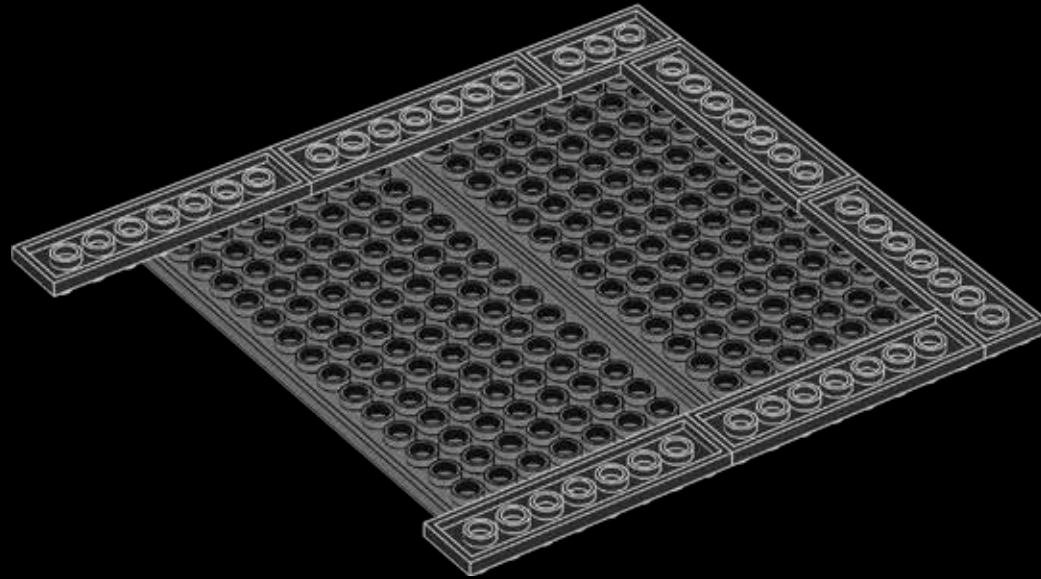

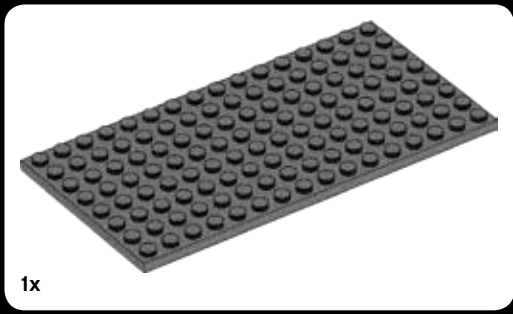

1x

5

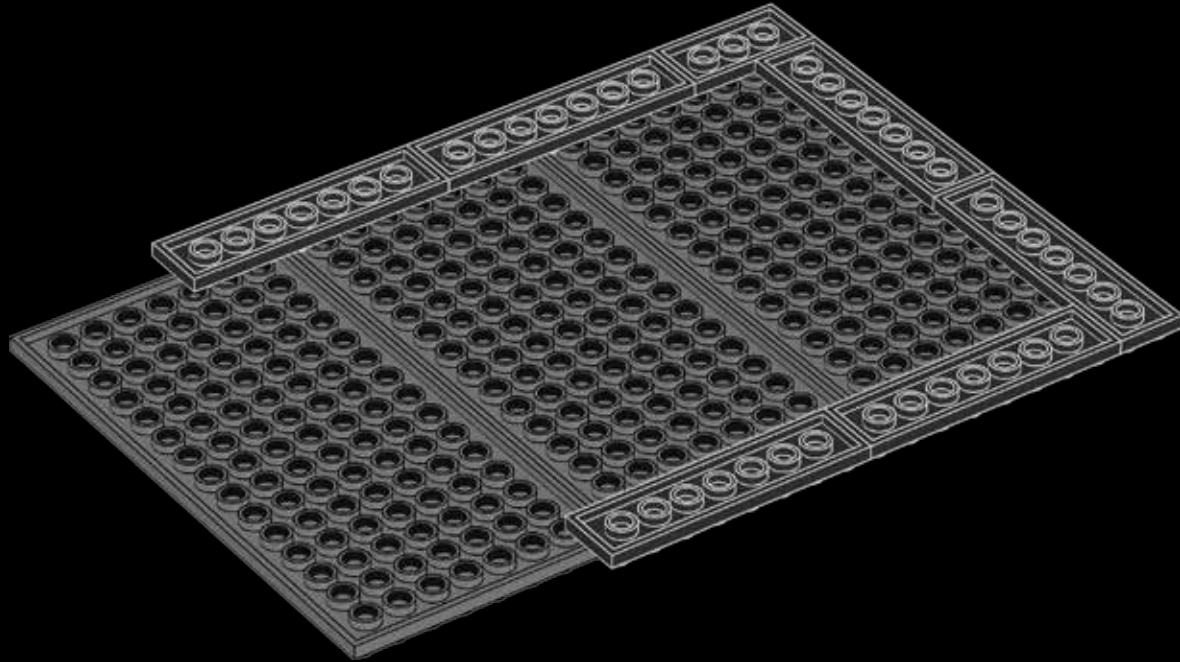



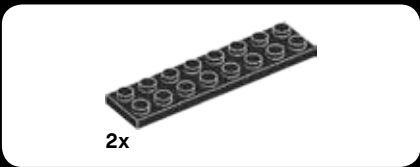

6

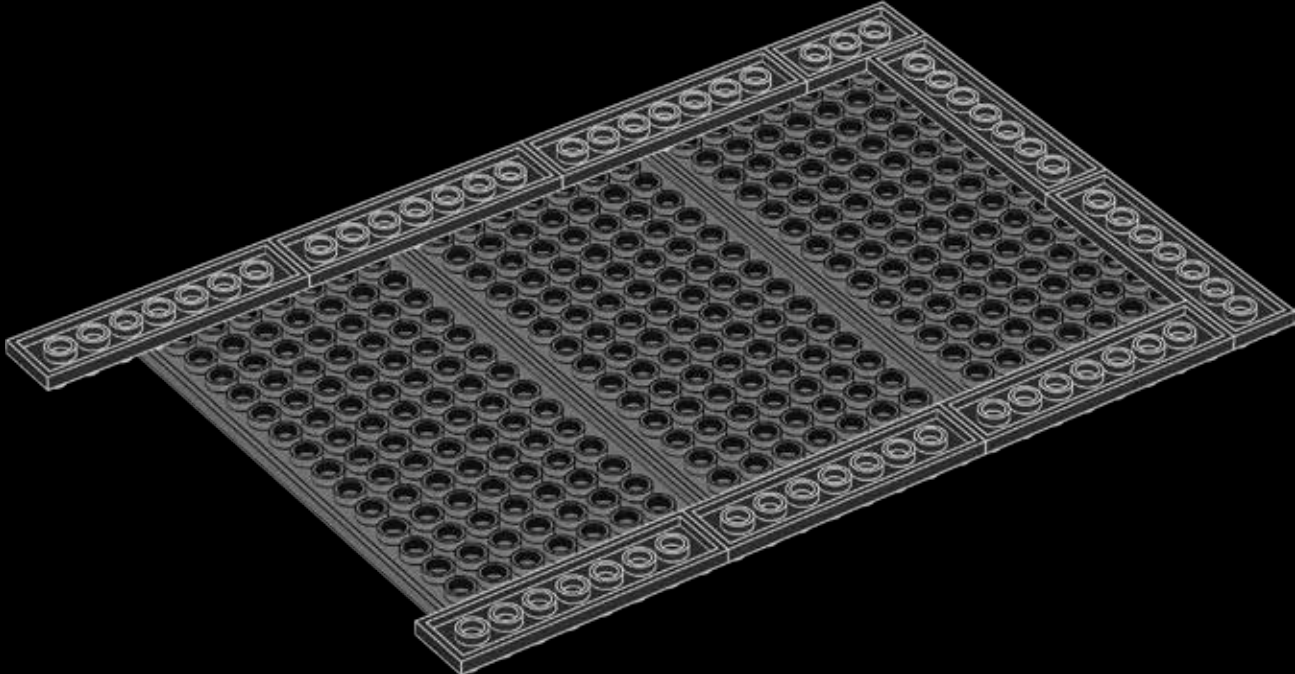



7

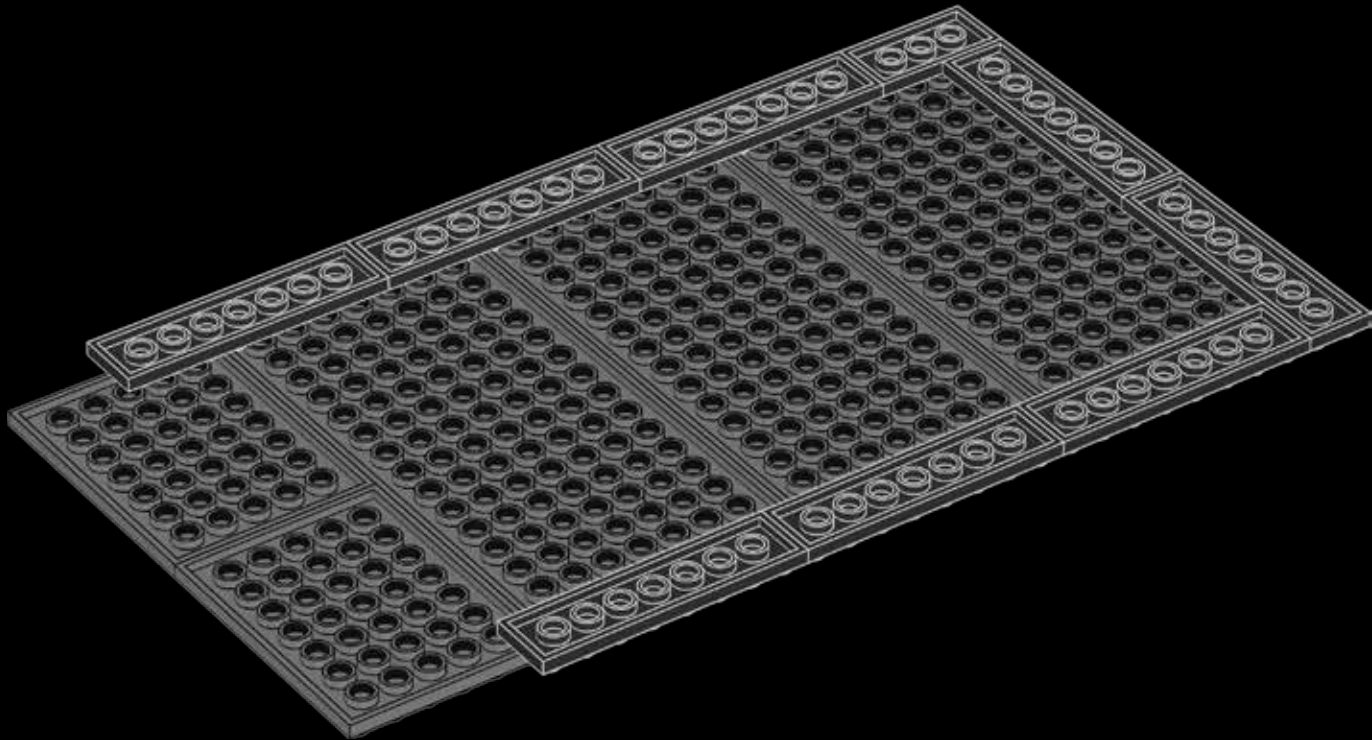

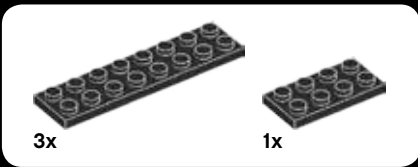

8

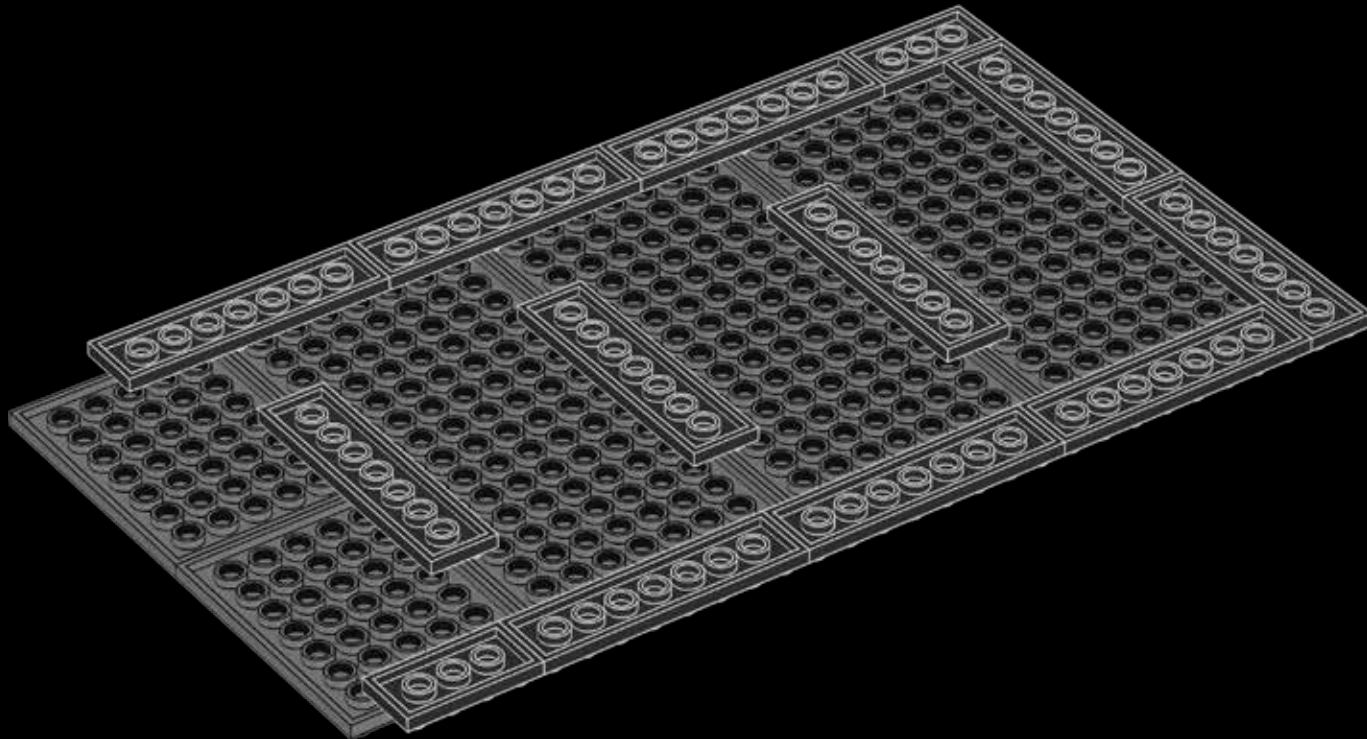

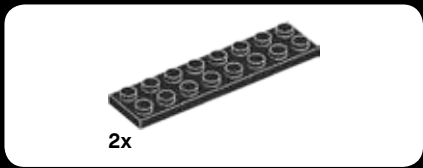

9

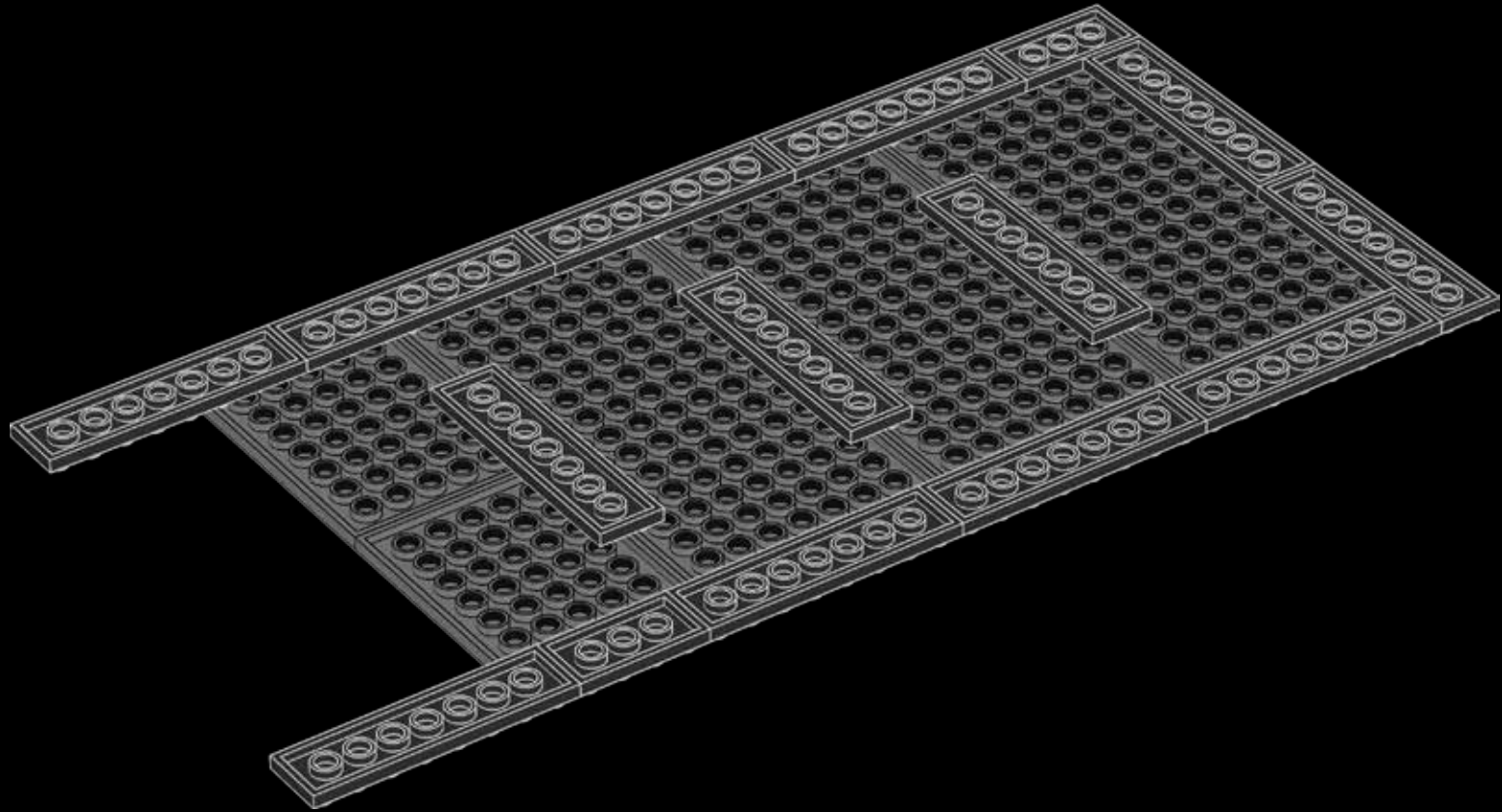

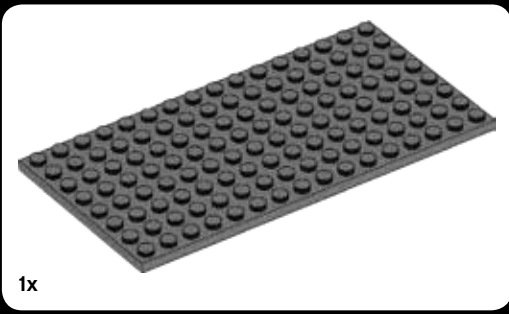

10

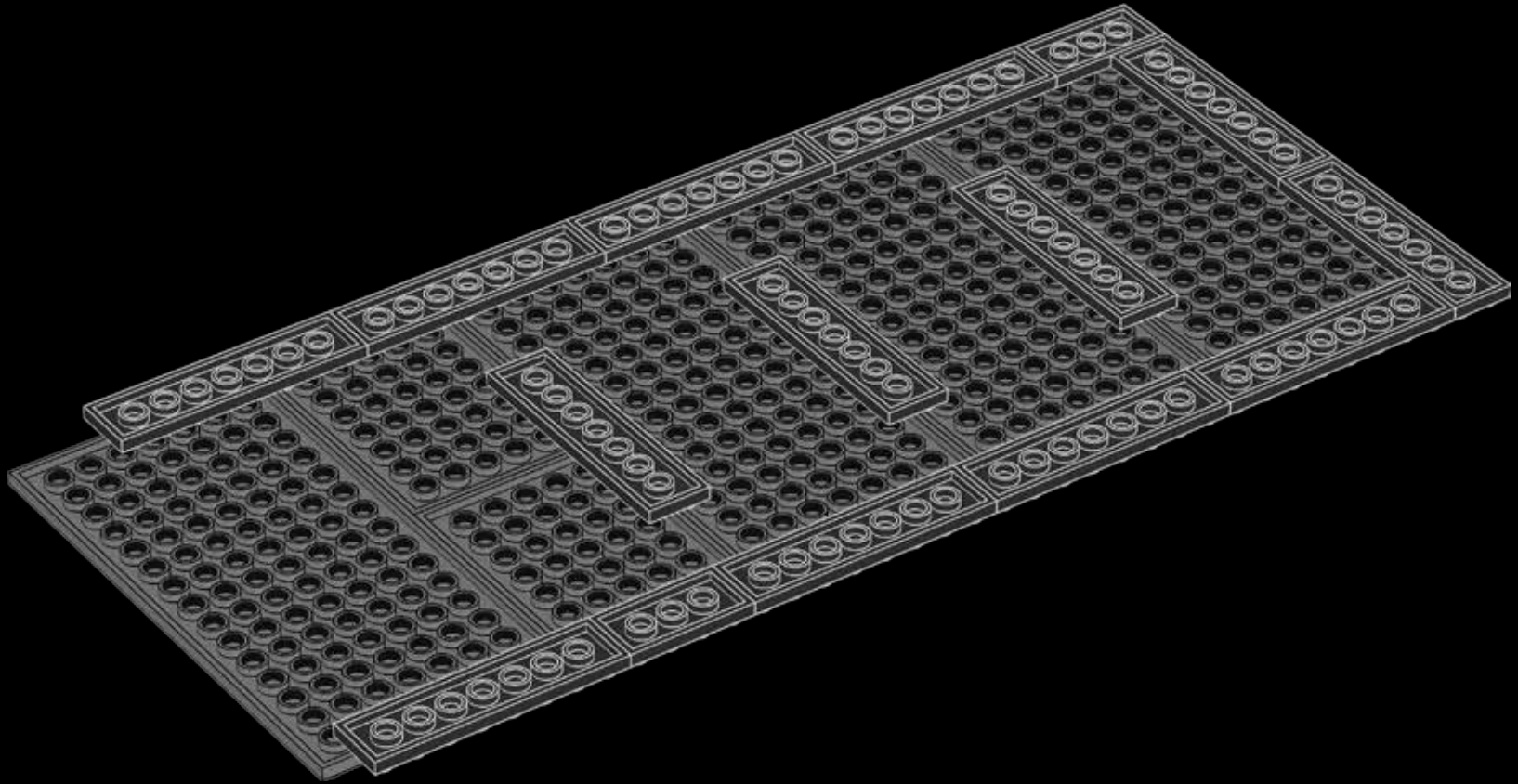

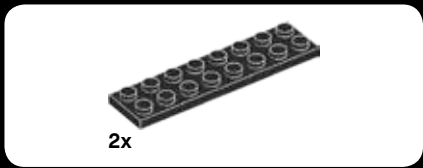

11

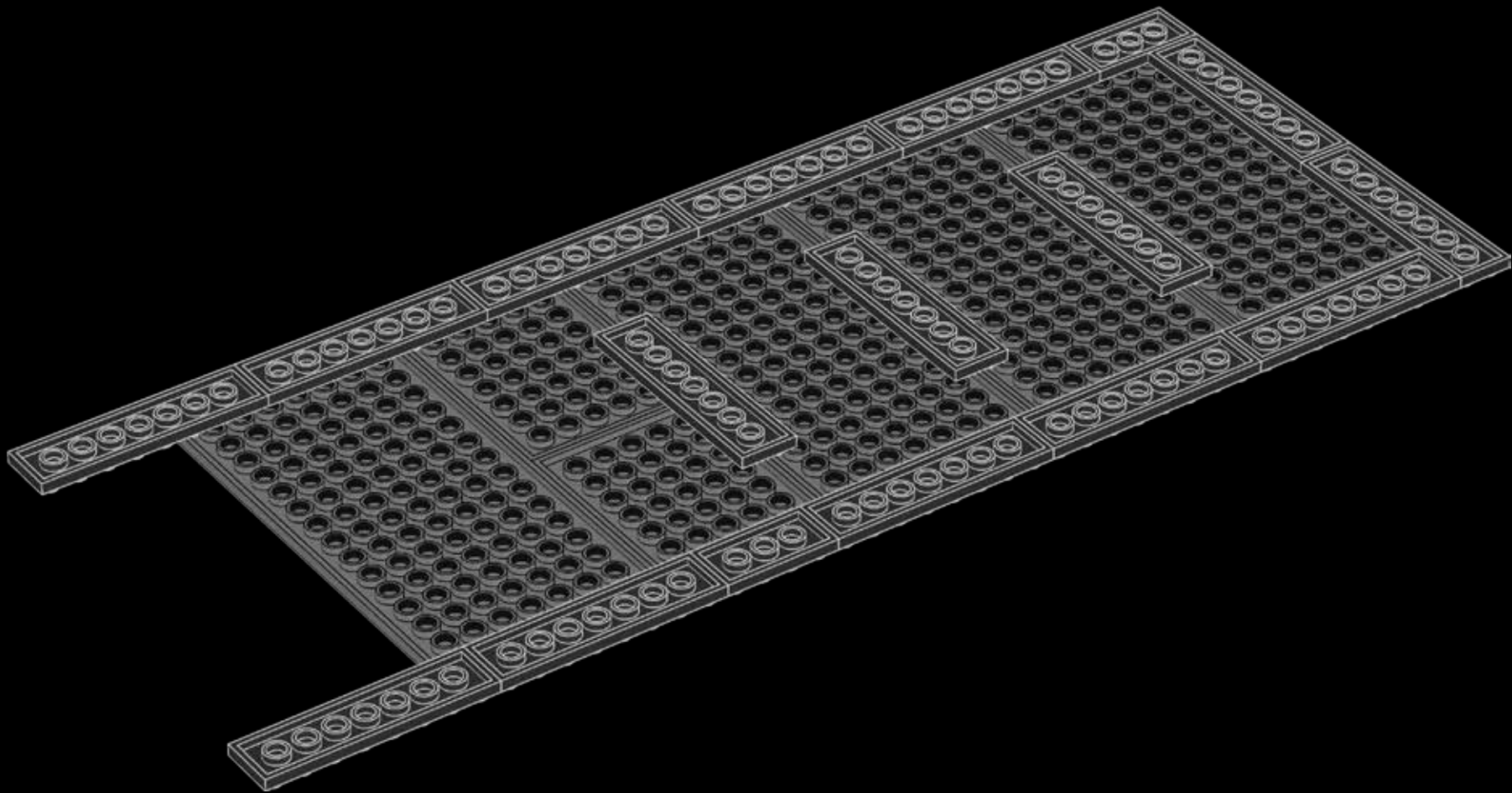

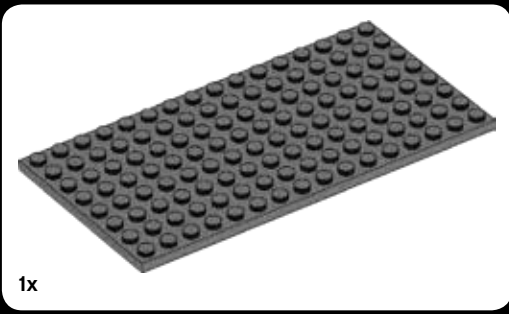

1x

12

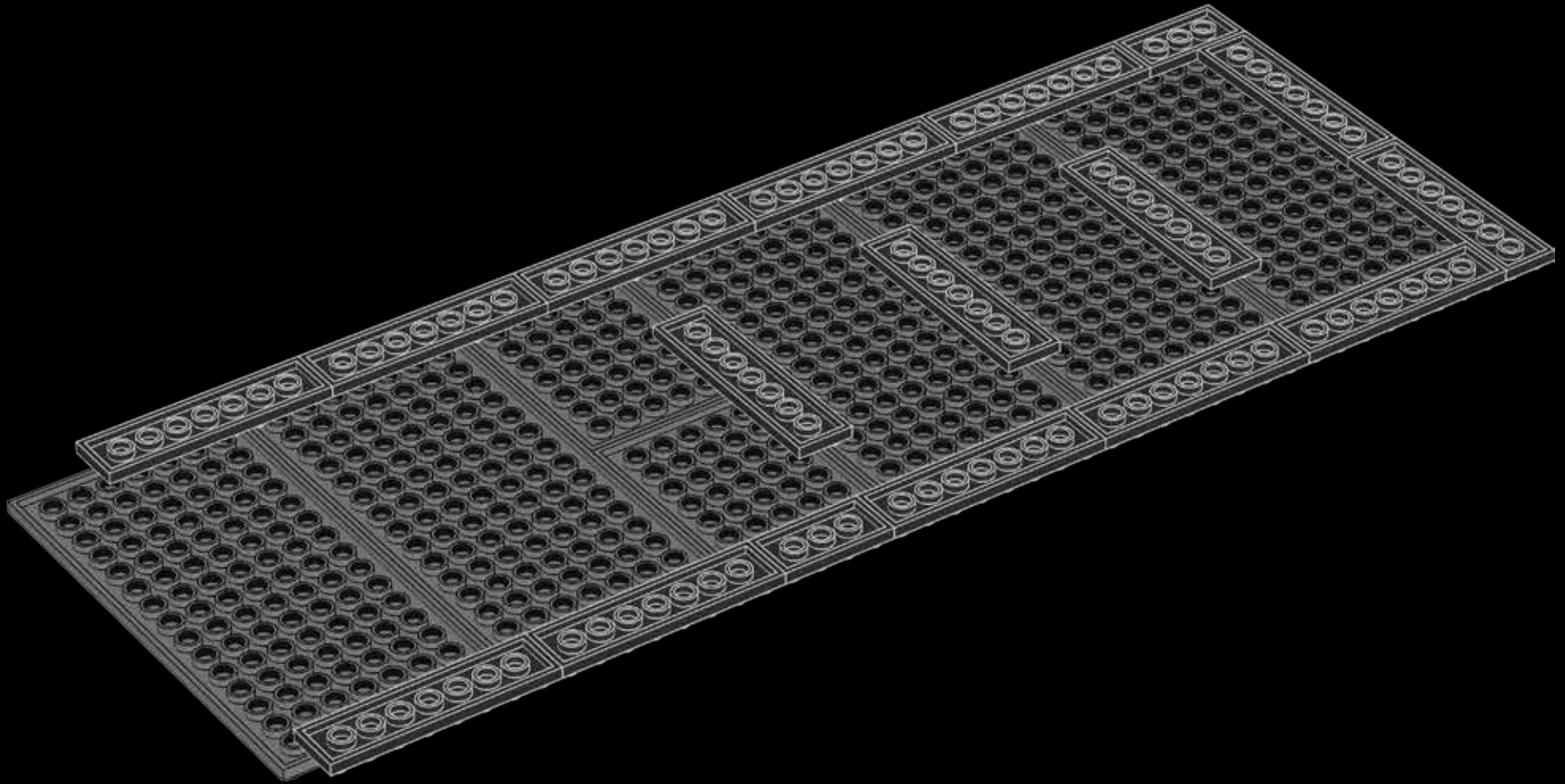

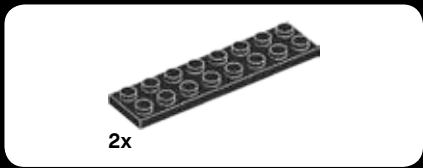

13

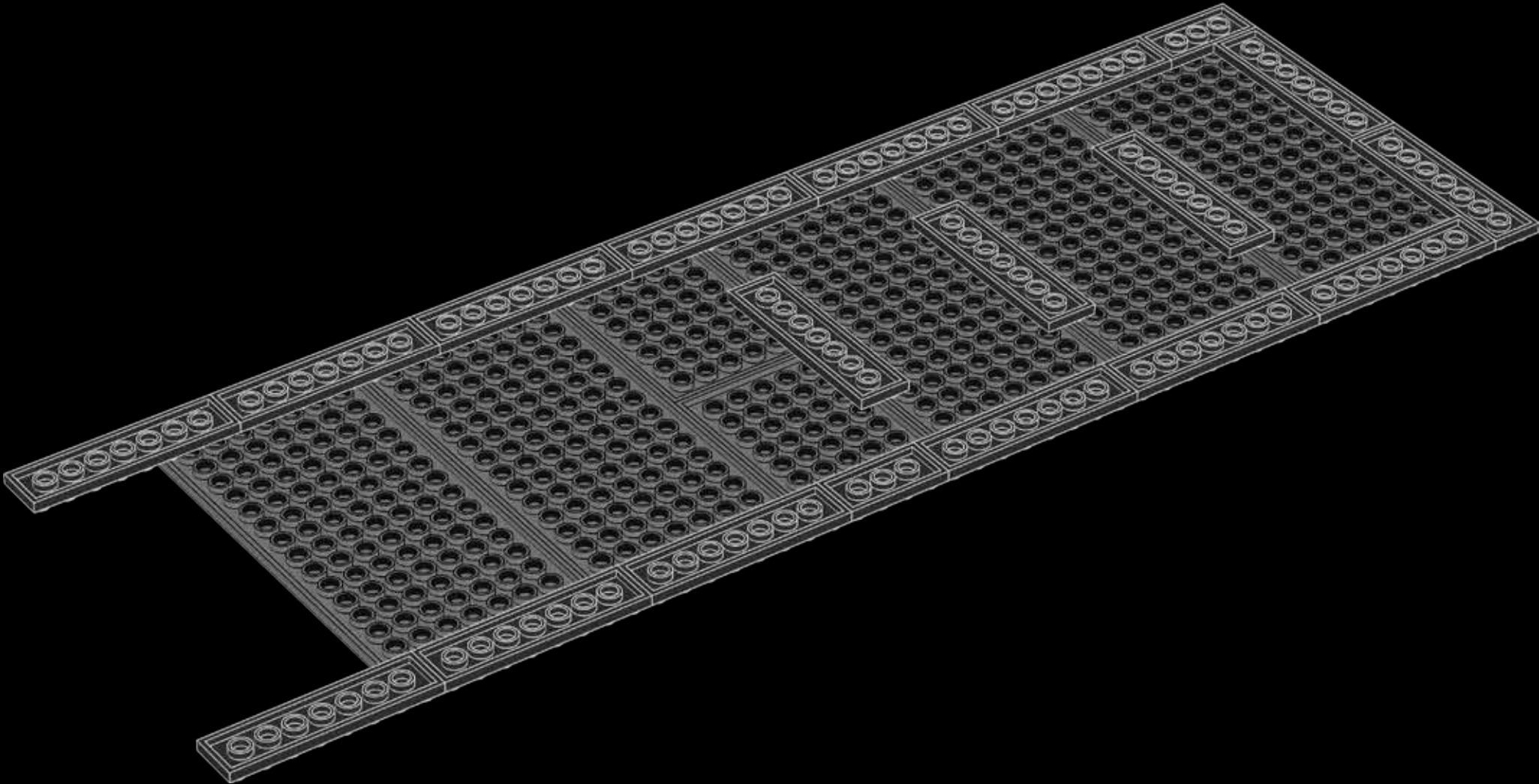



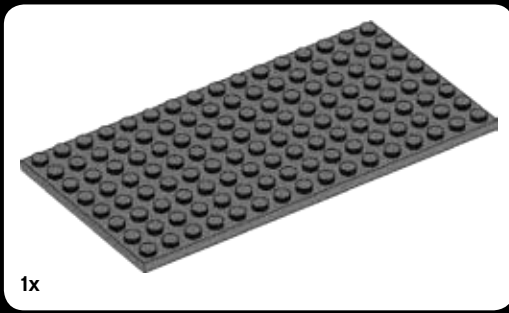

1x

14

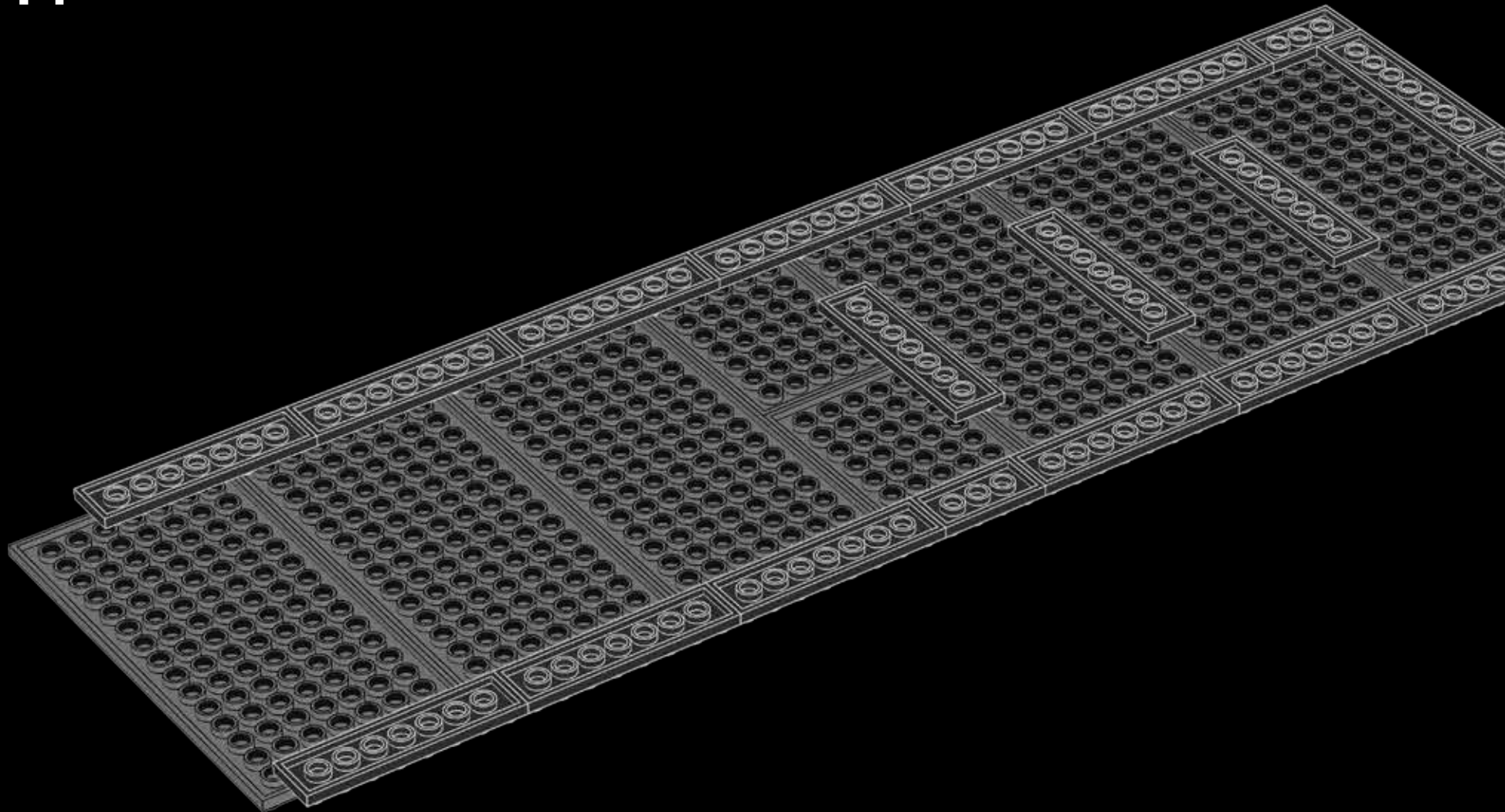



1x

15

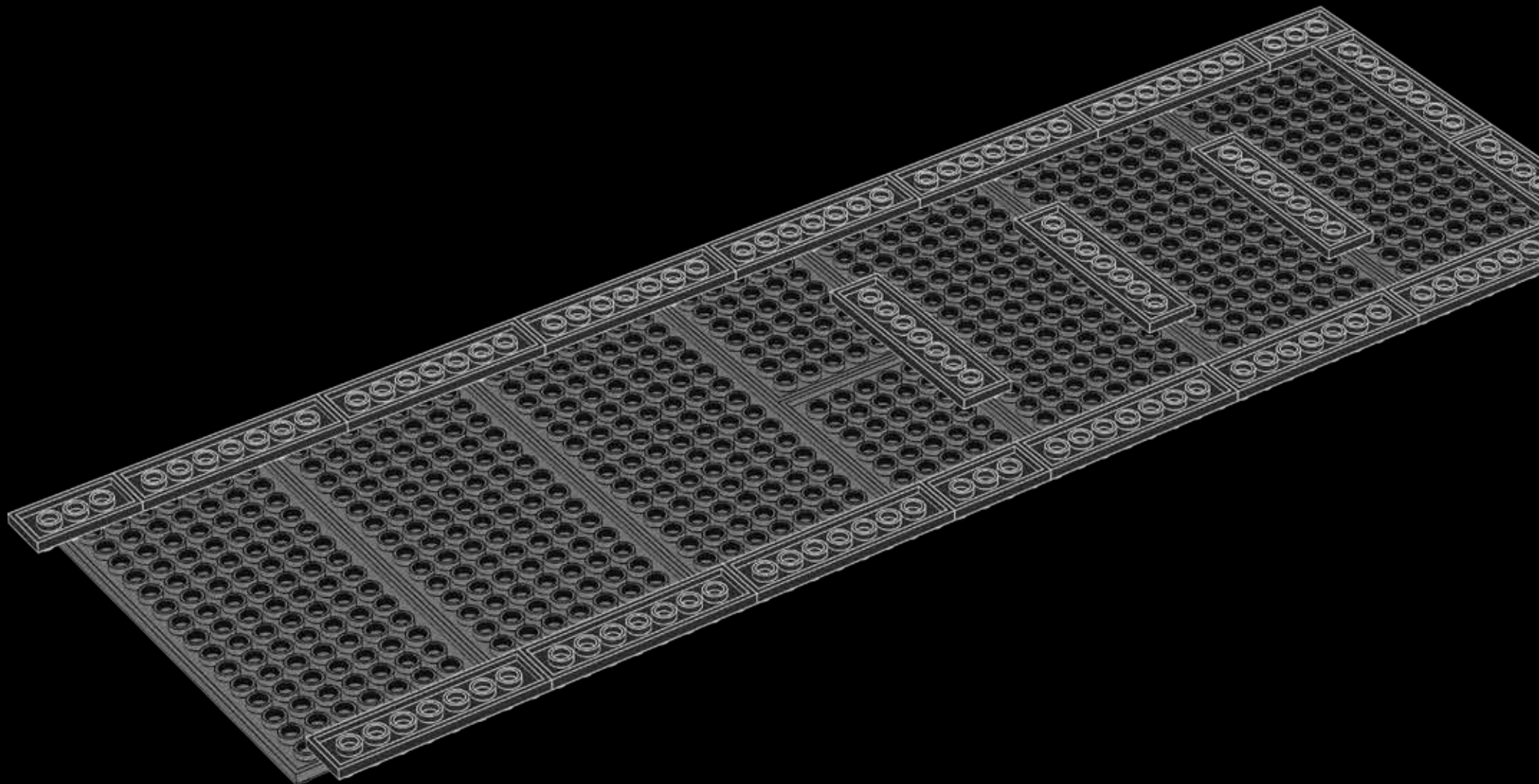

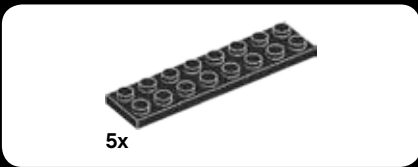

16

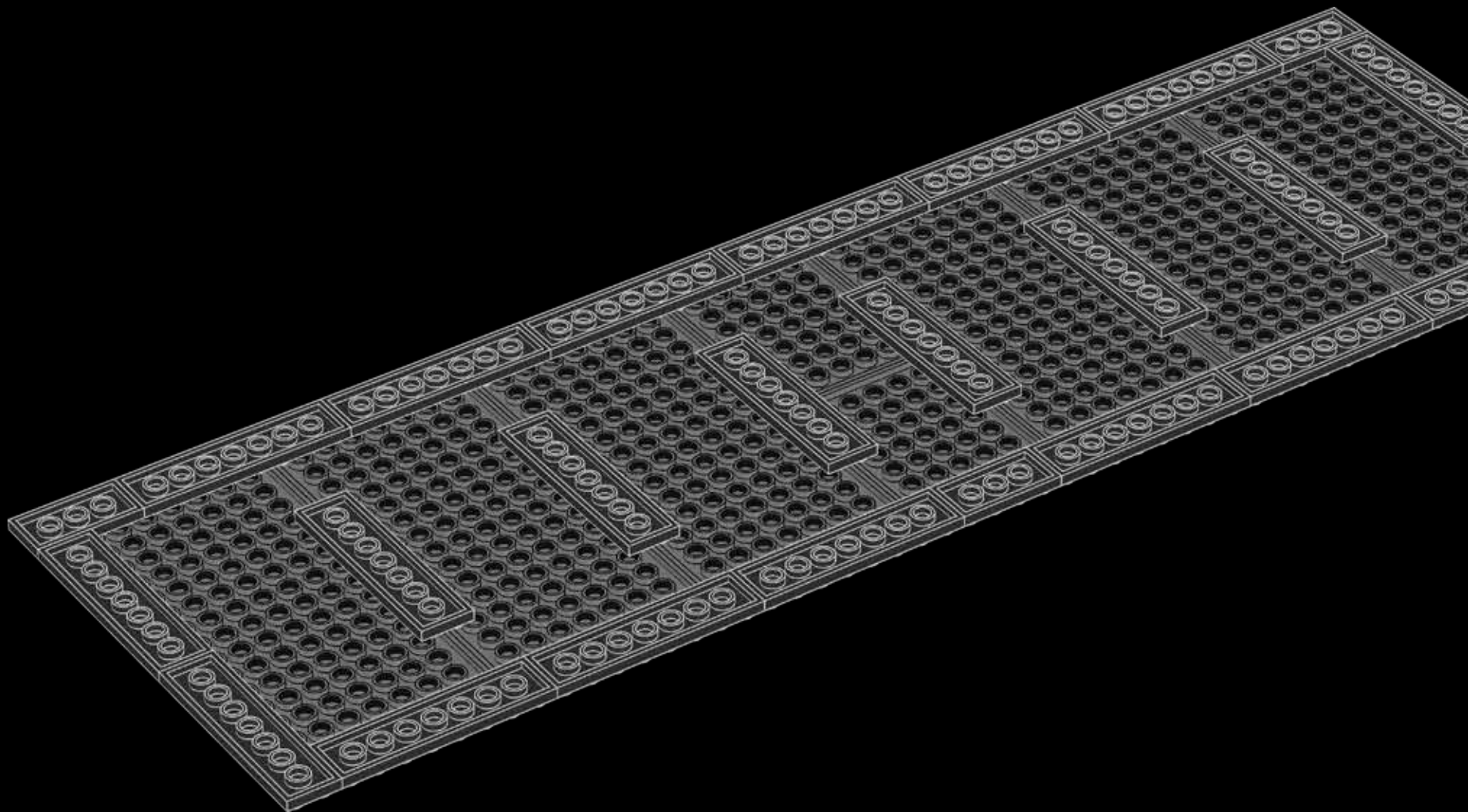

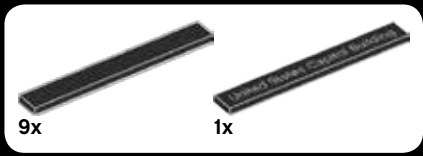

17

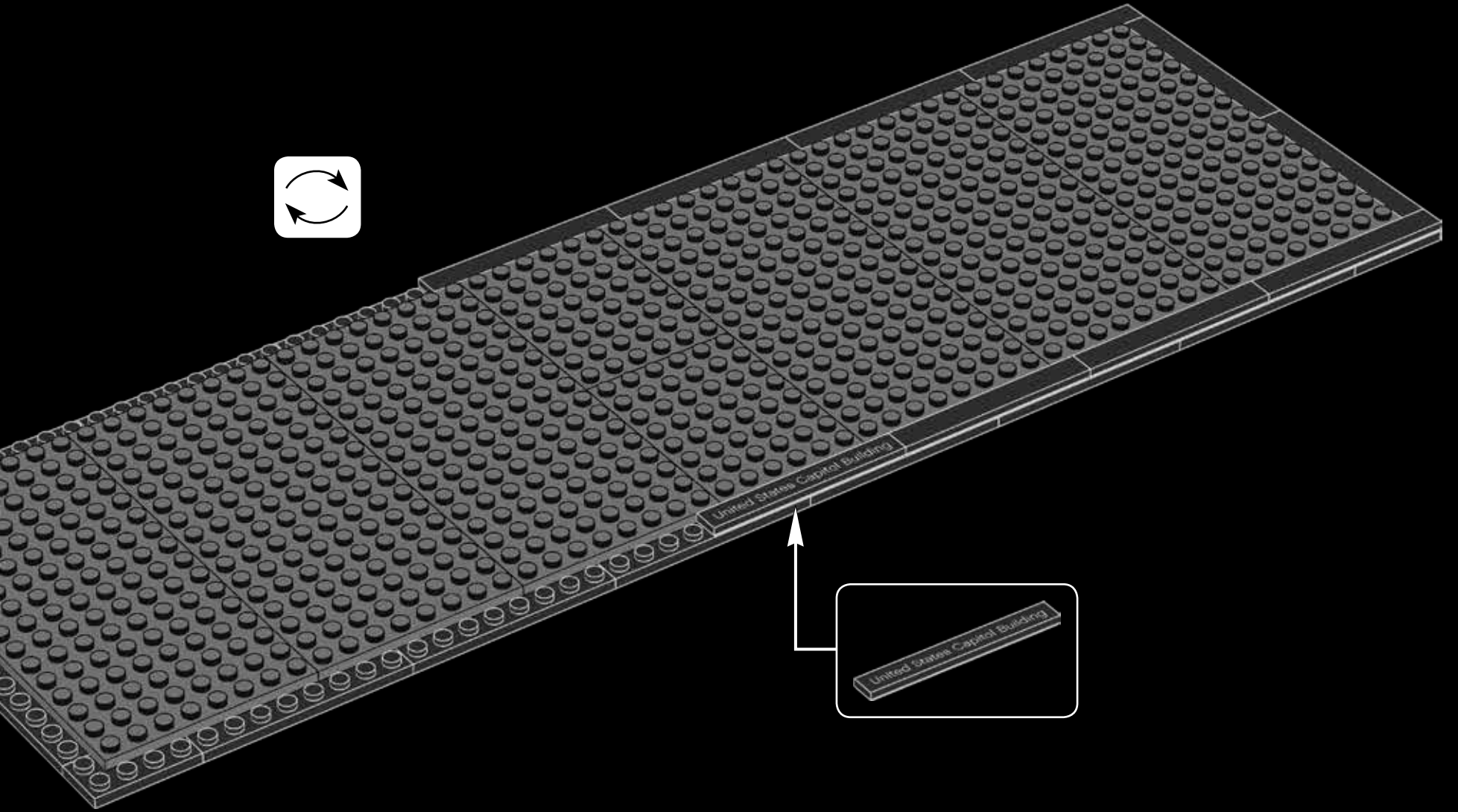



18

The Capitol's architect William Thornton's design was inspired by the east front of the Louvre in Paris, France.

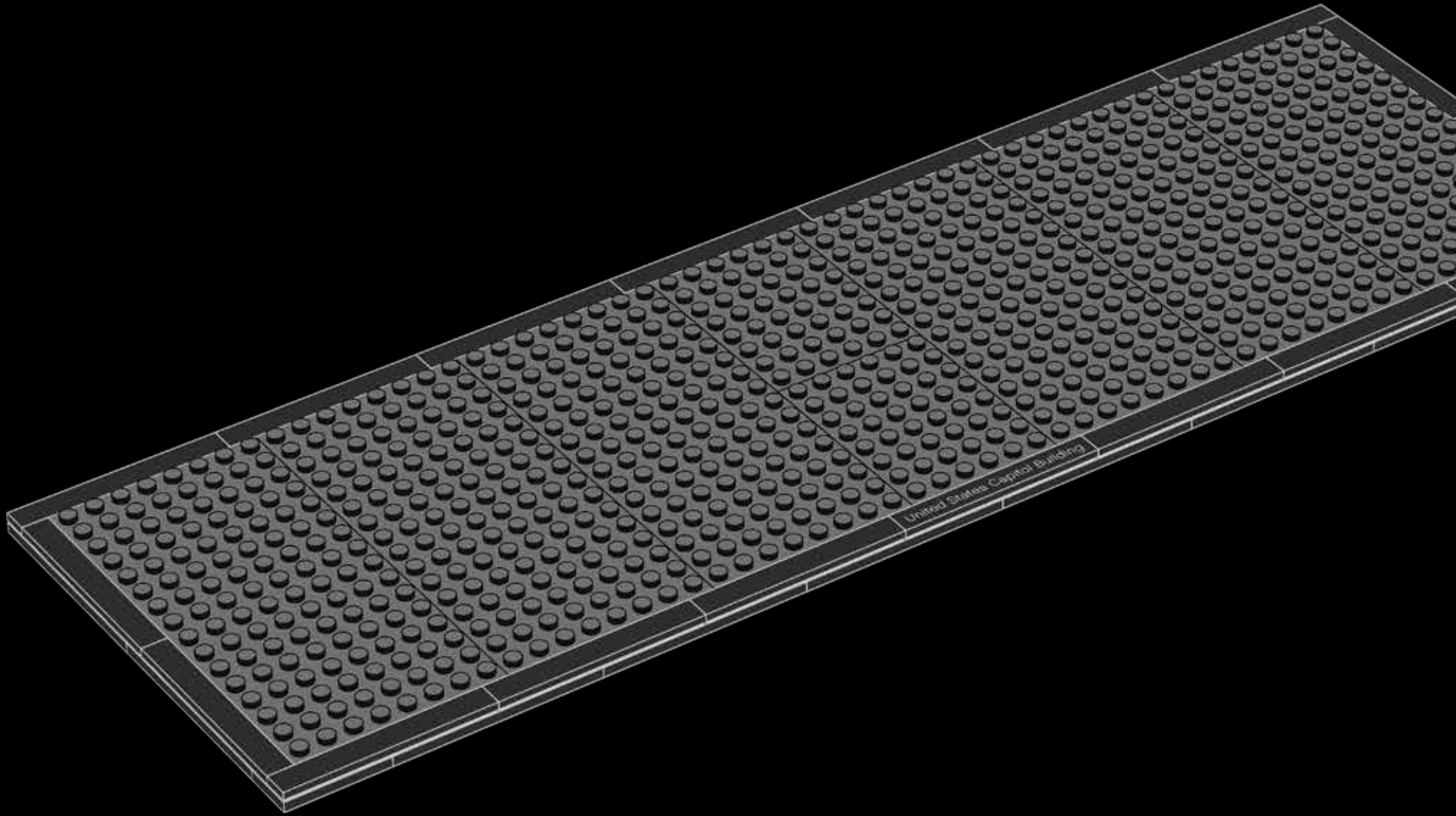

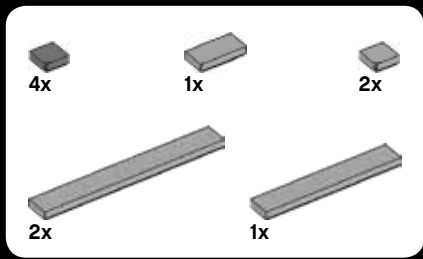

19

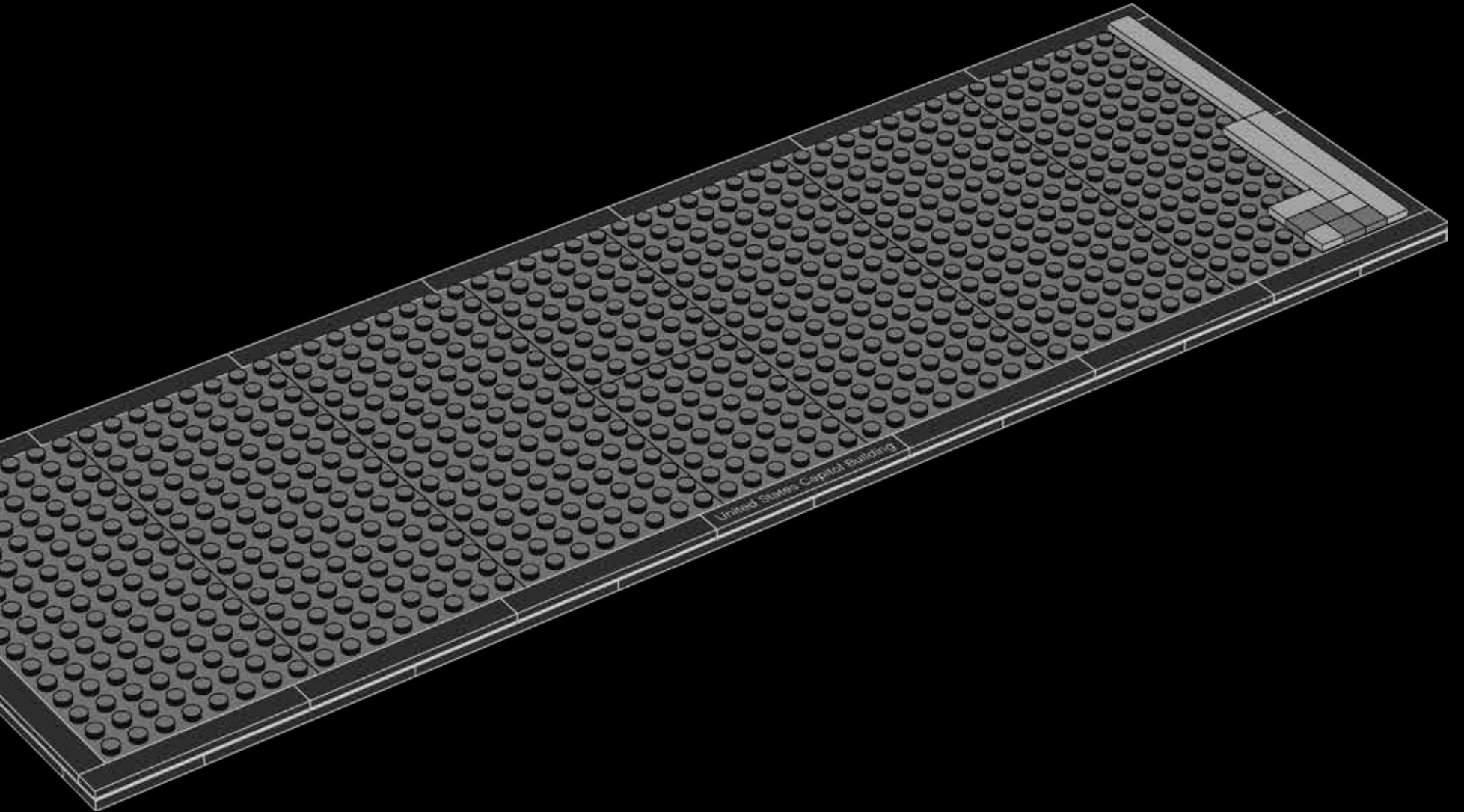

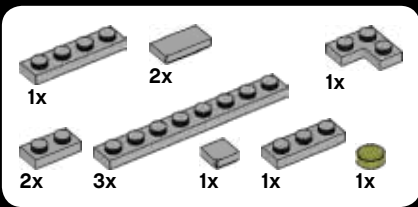

20

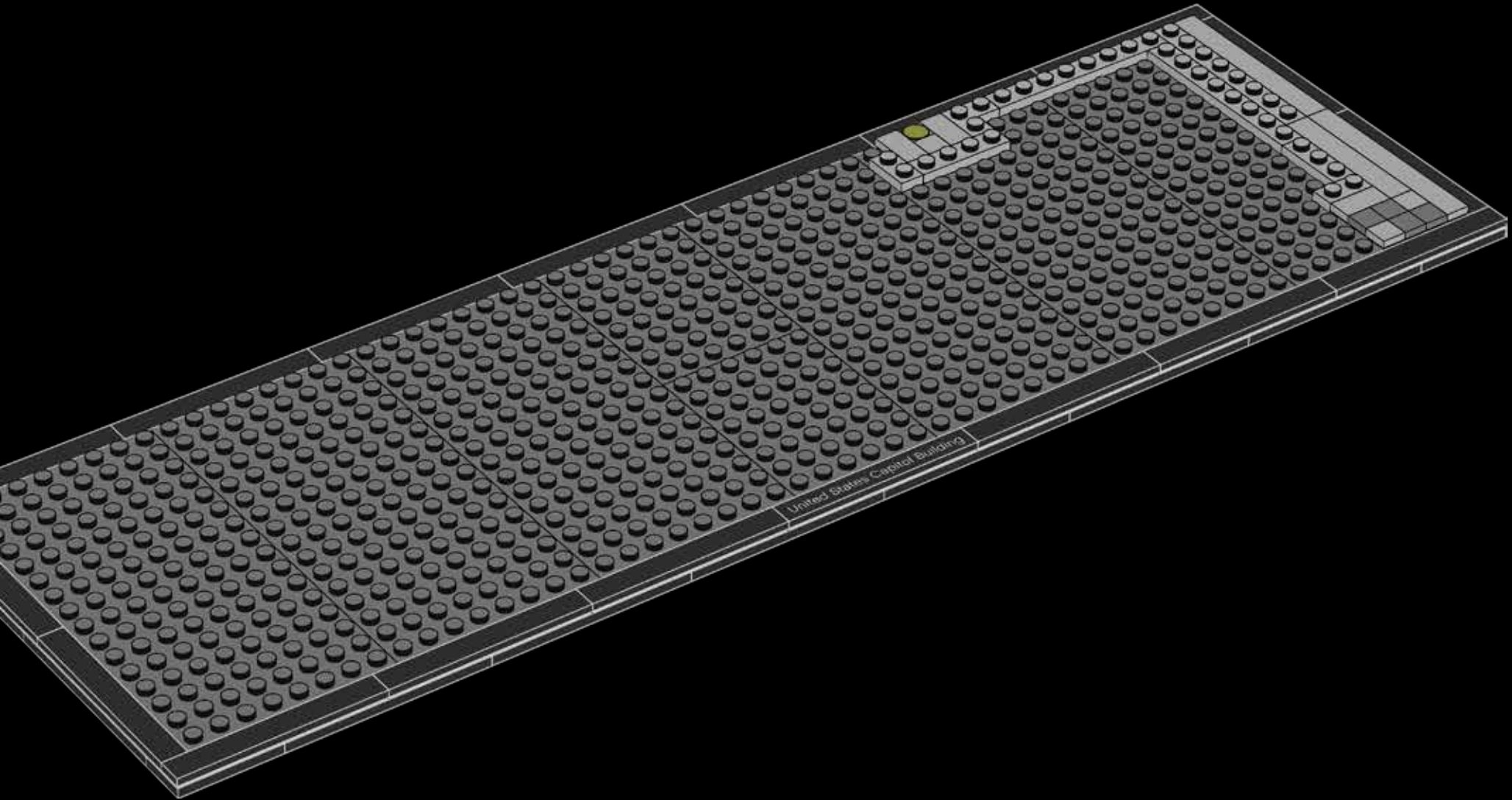

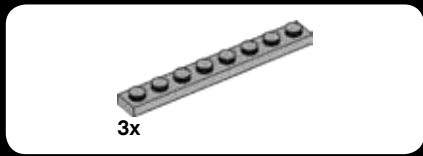

21

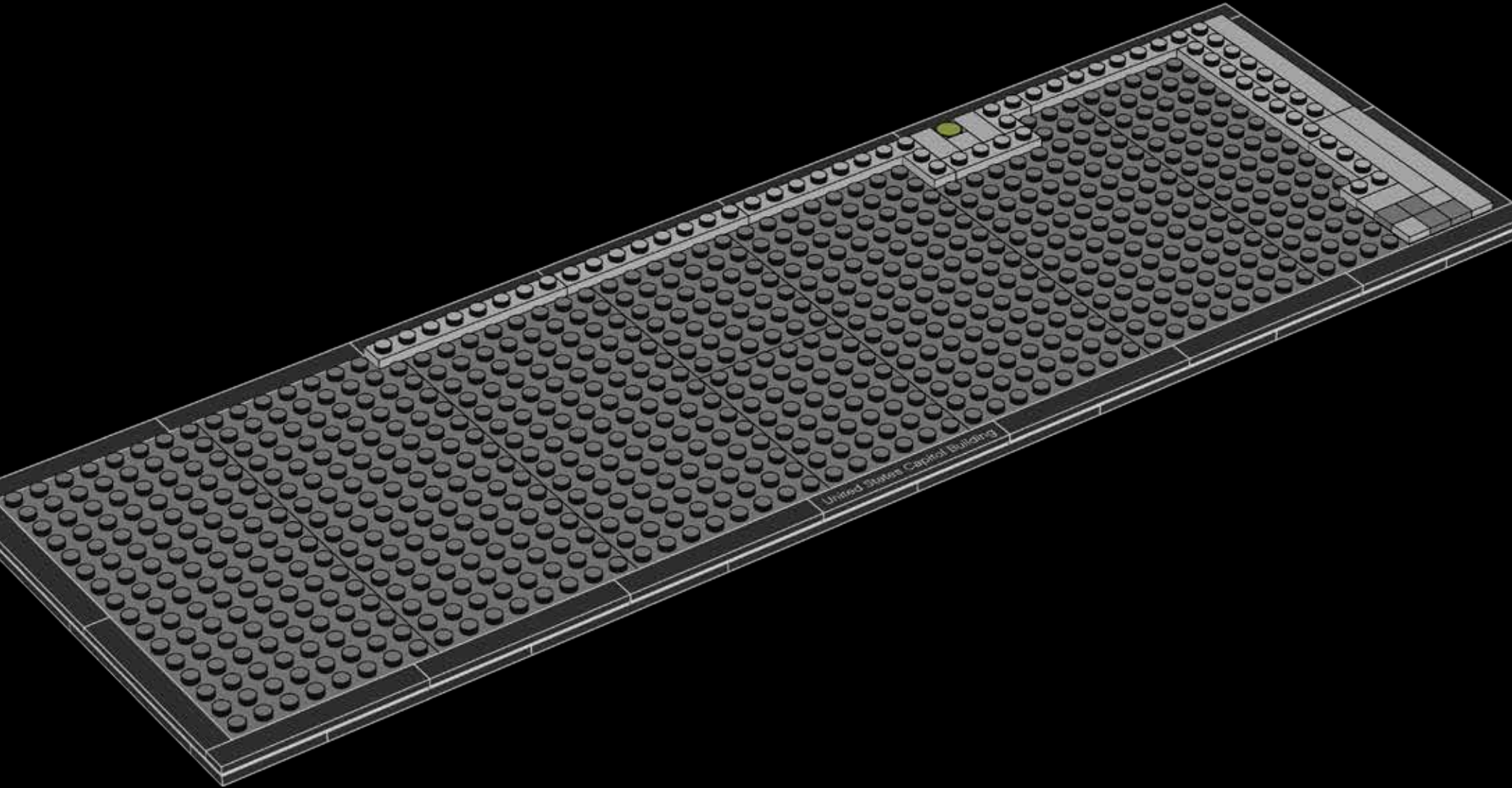



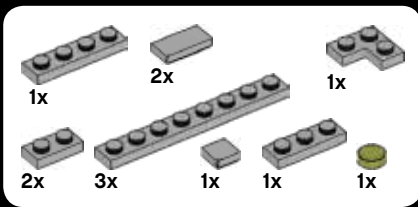

22

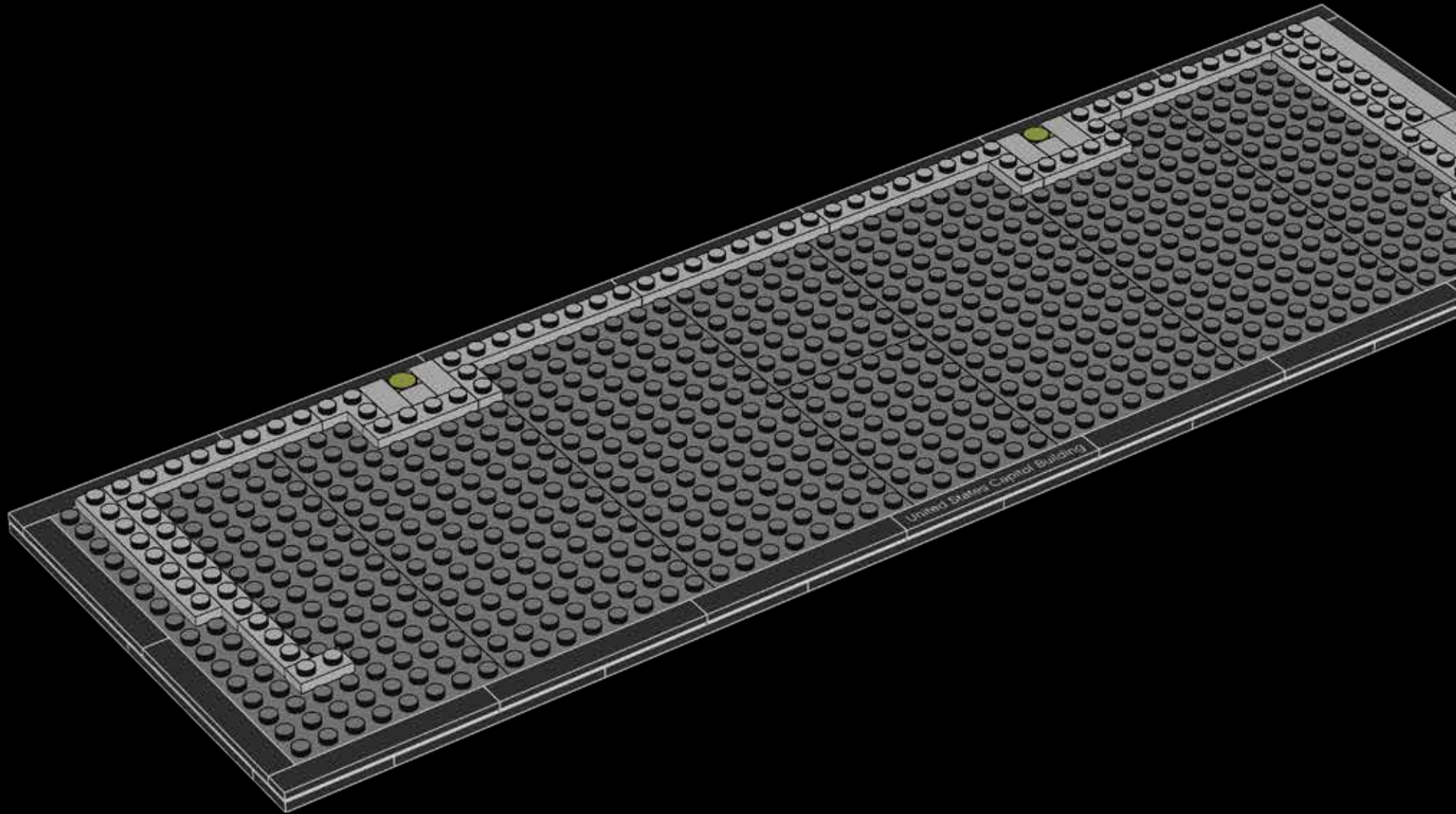

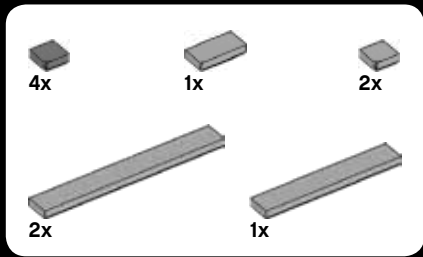

23

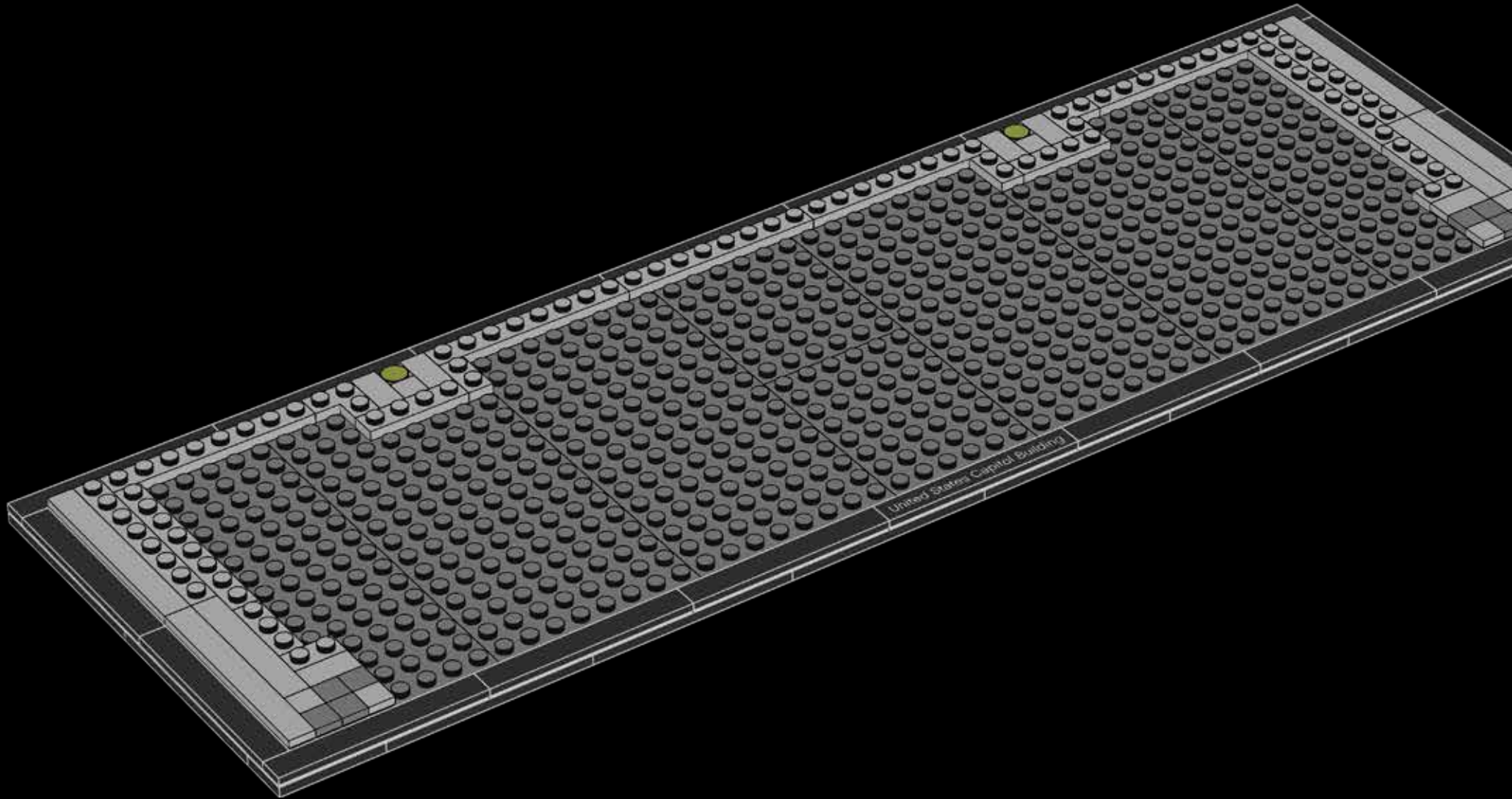



24

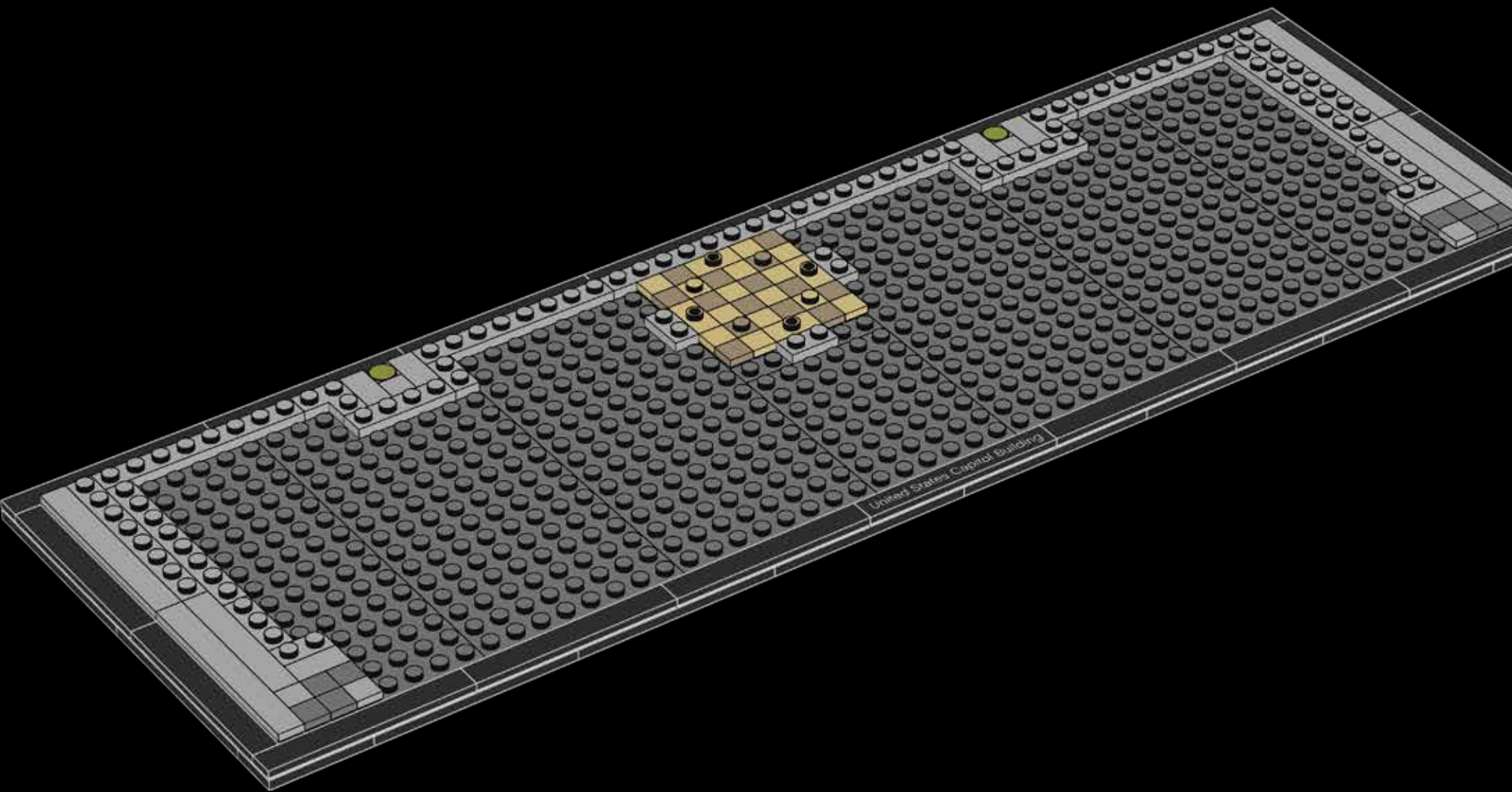



25

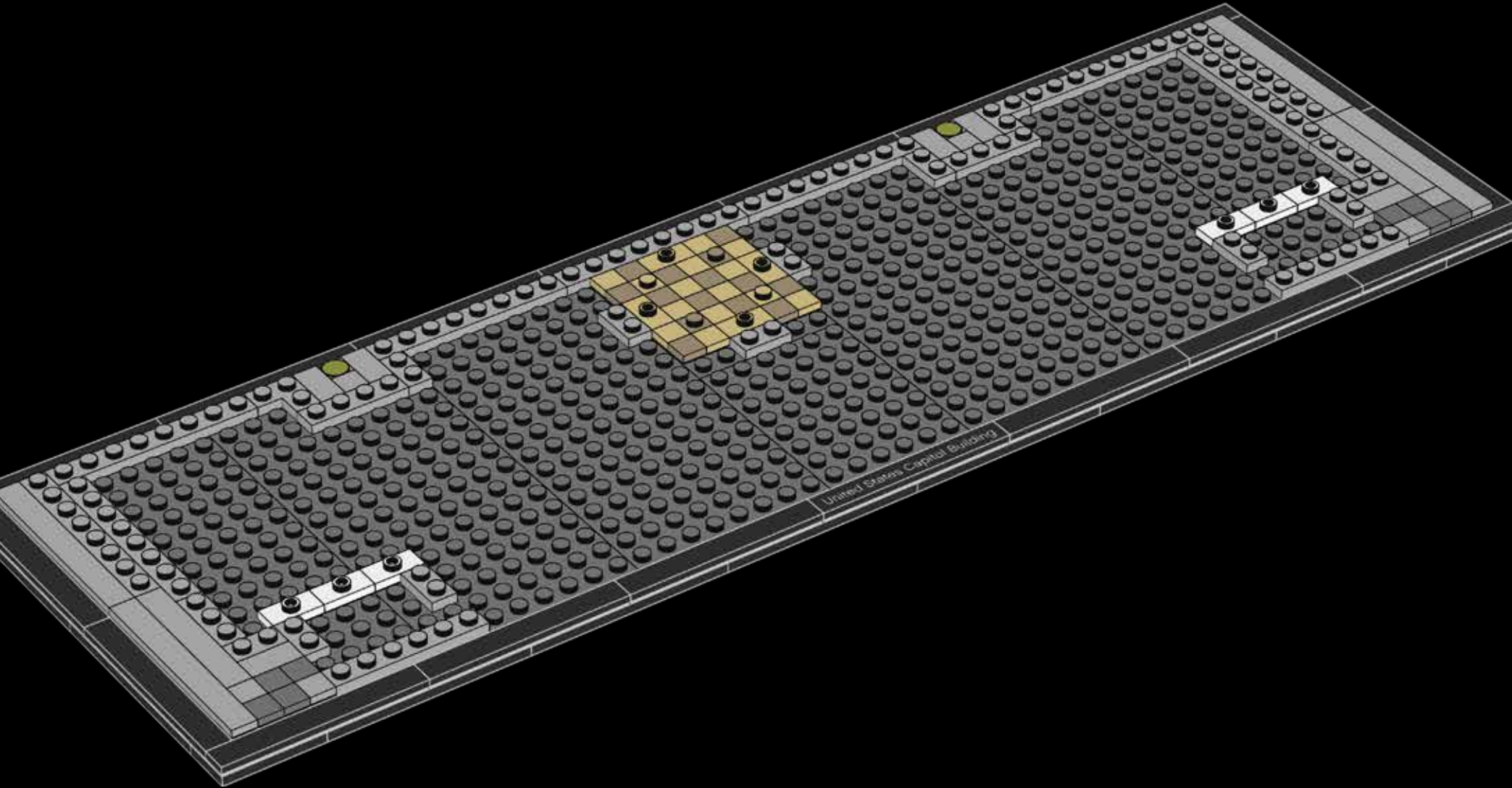

10x 4x 2x

26

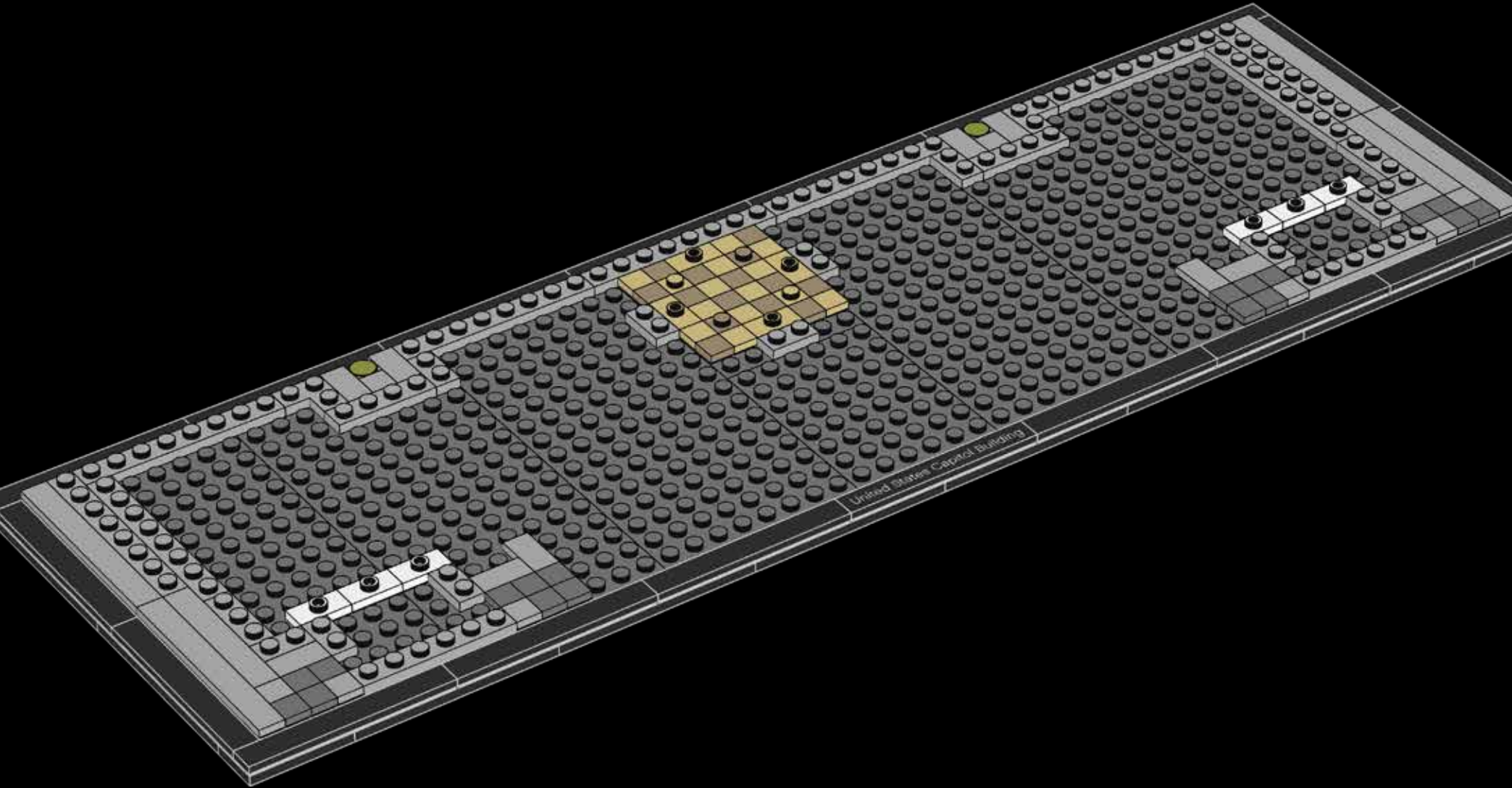

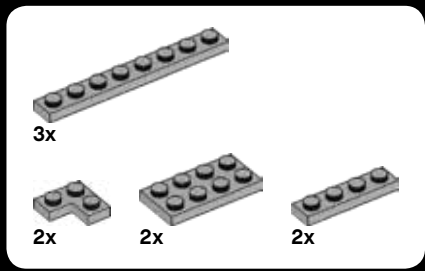

27

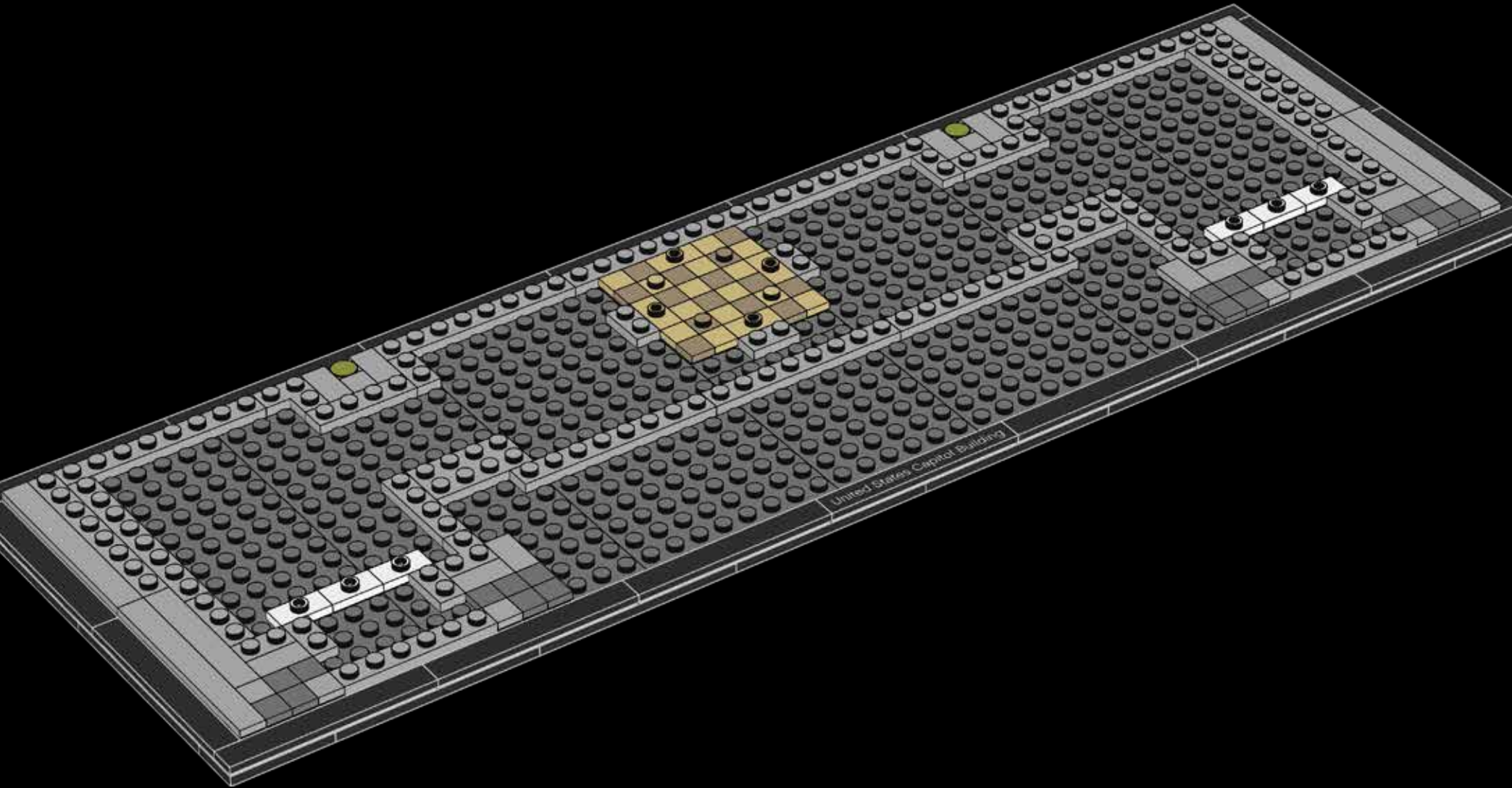

2x 2x 10x

28

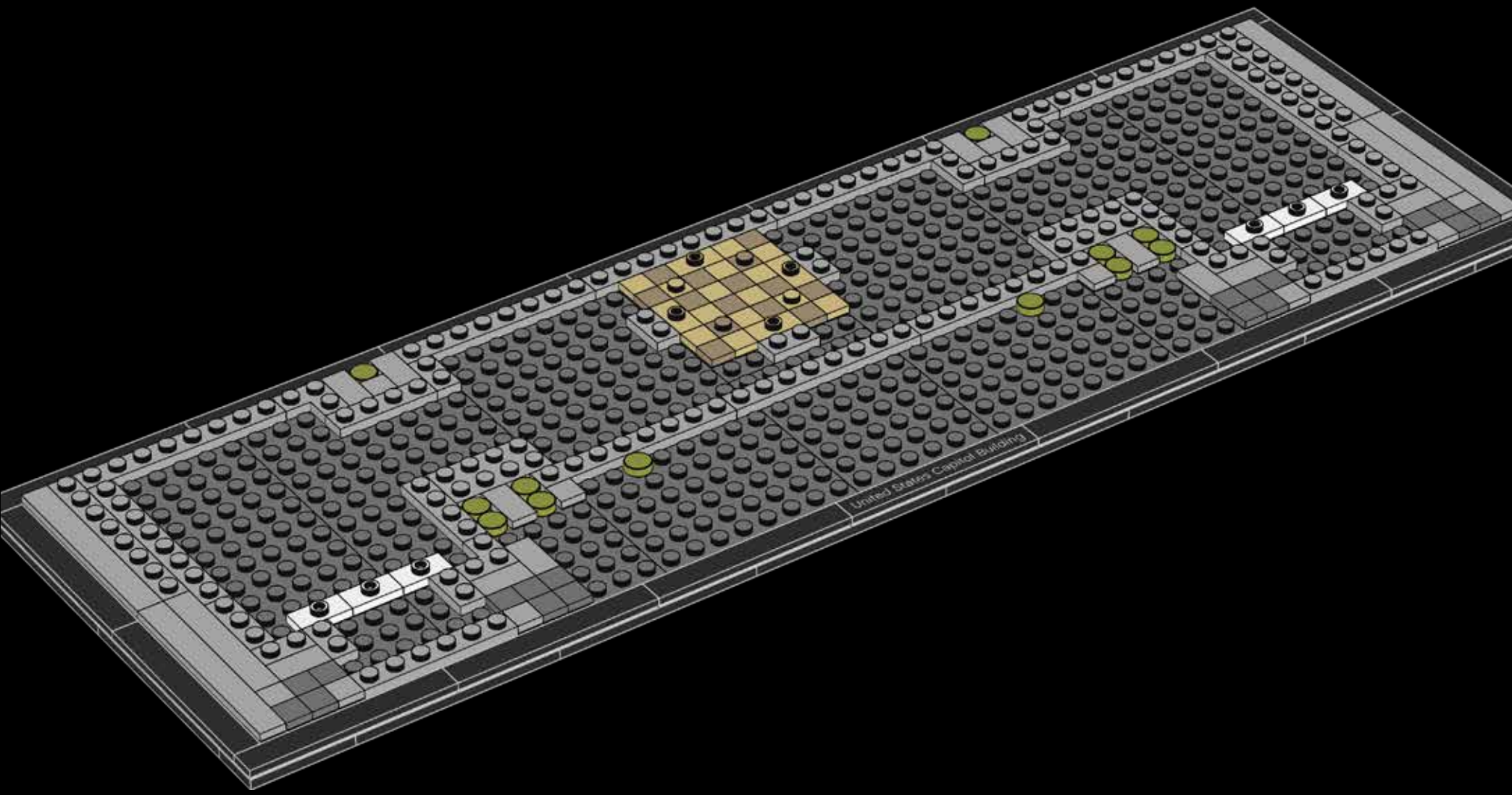

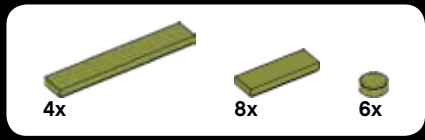

29

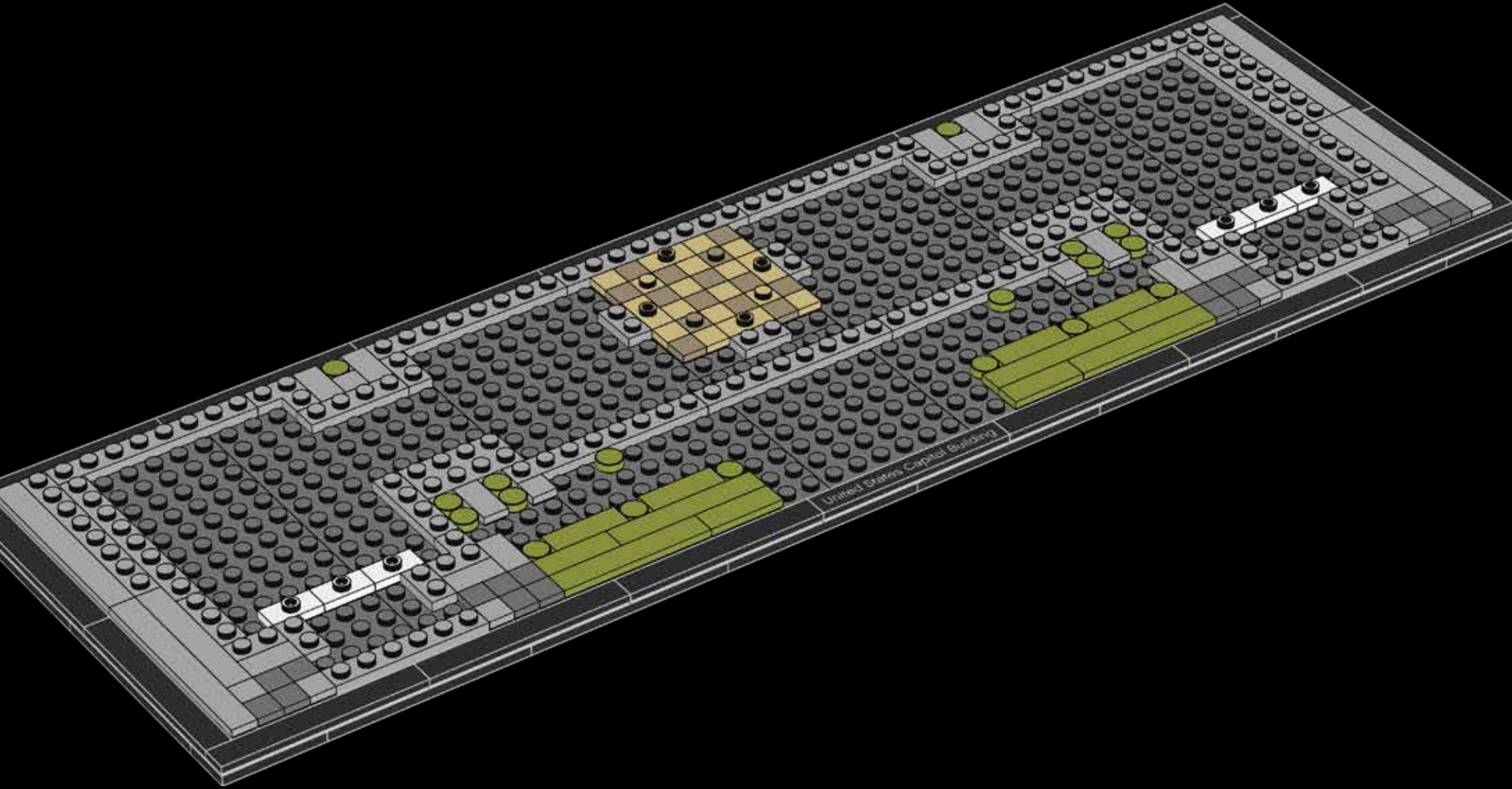



26x

30

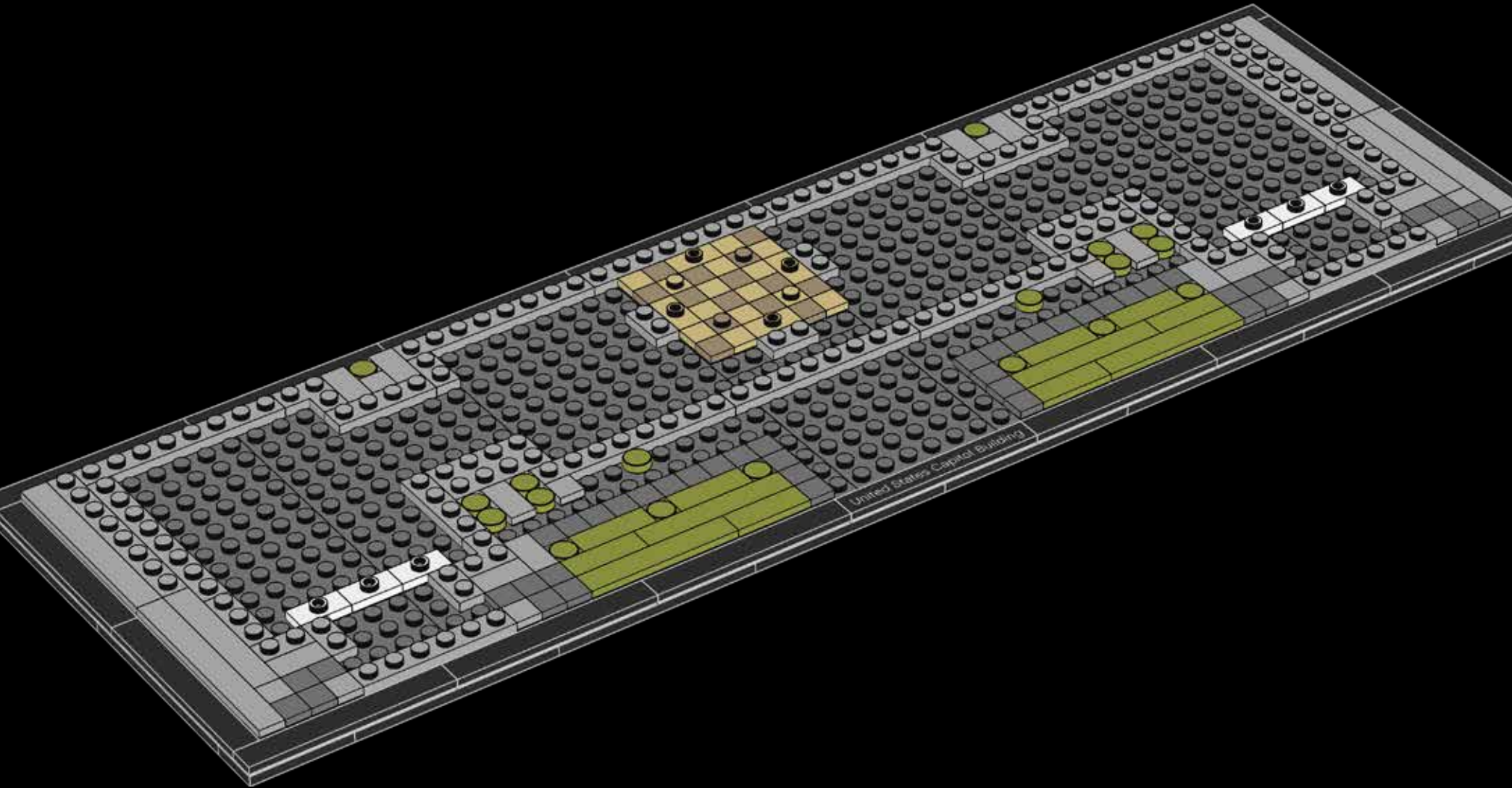

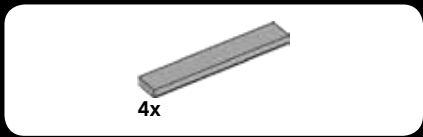

31

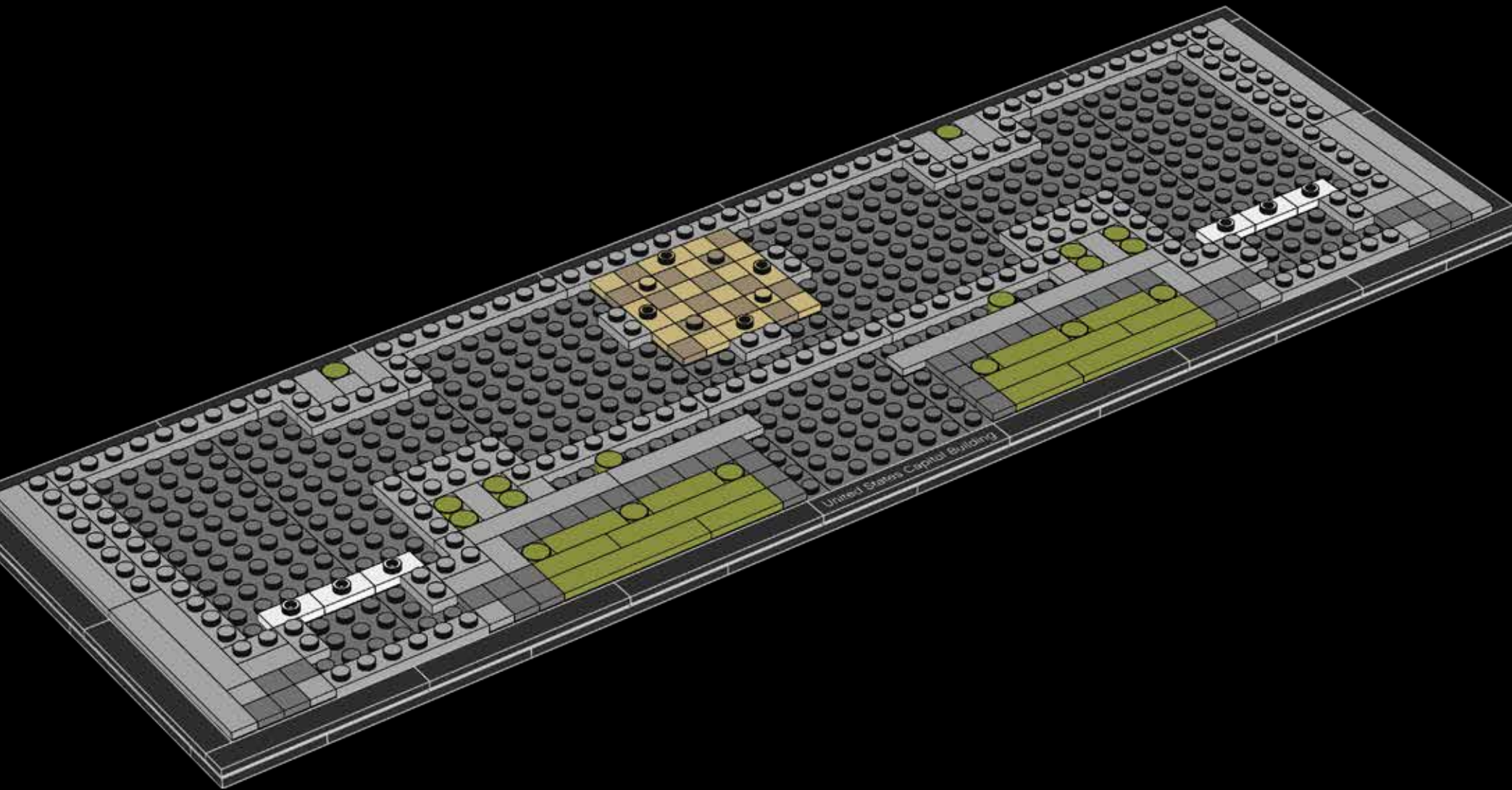



2x



2x

32

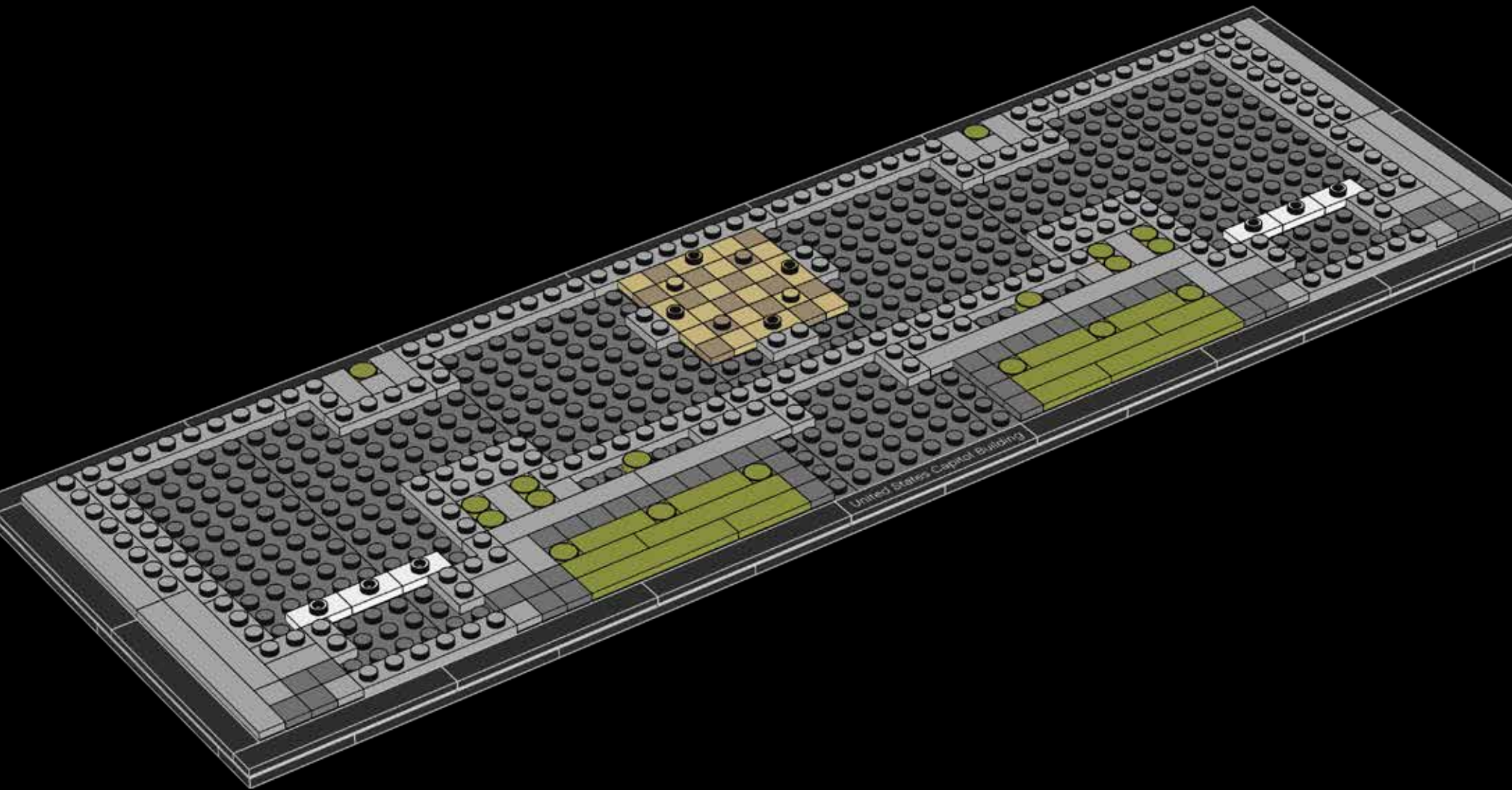

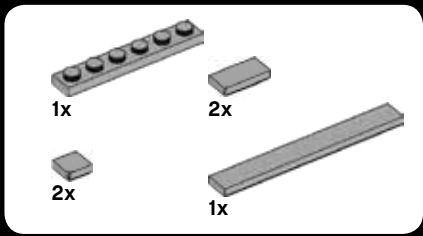

33

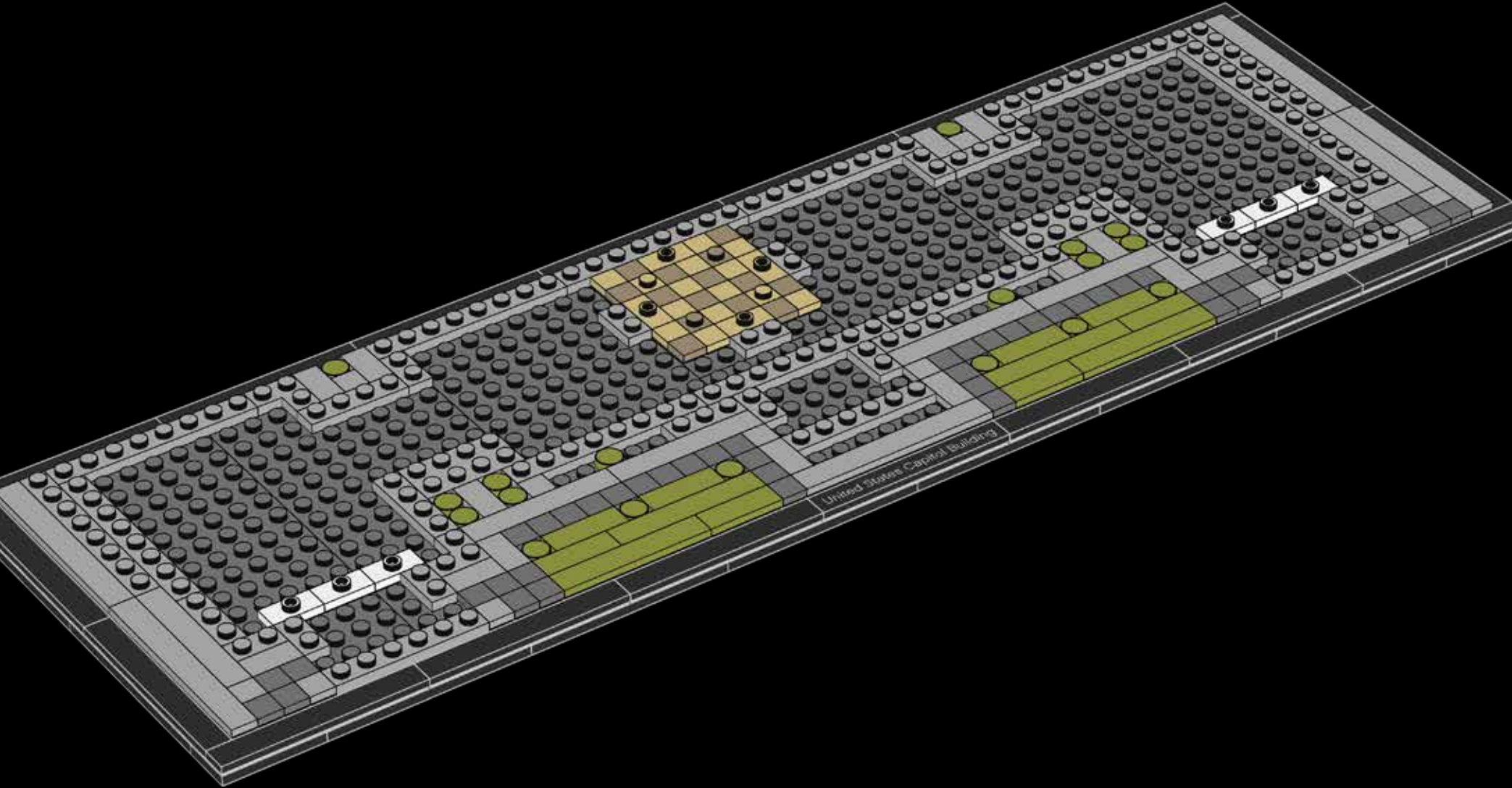



6x

34

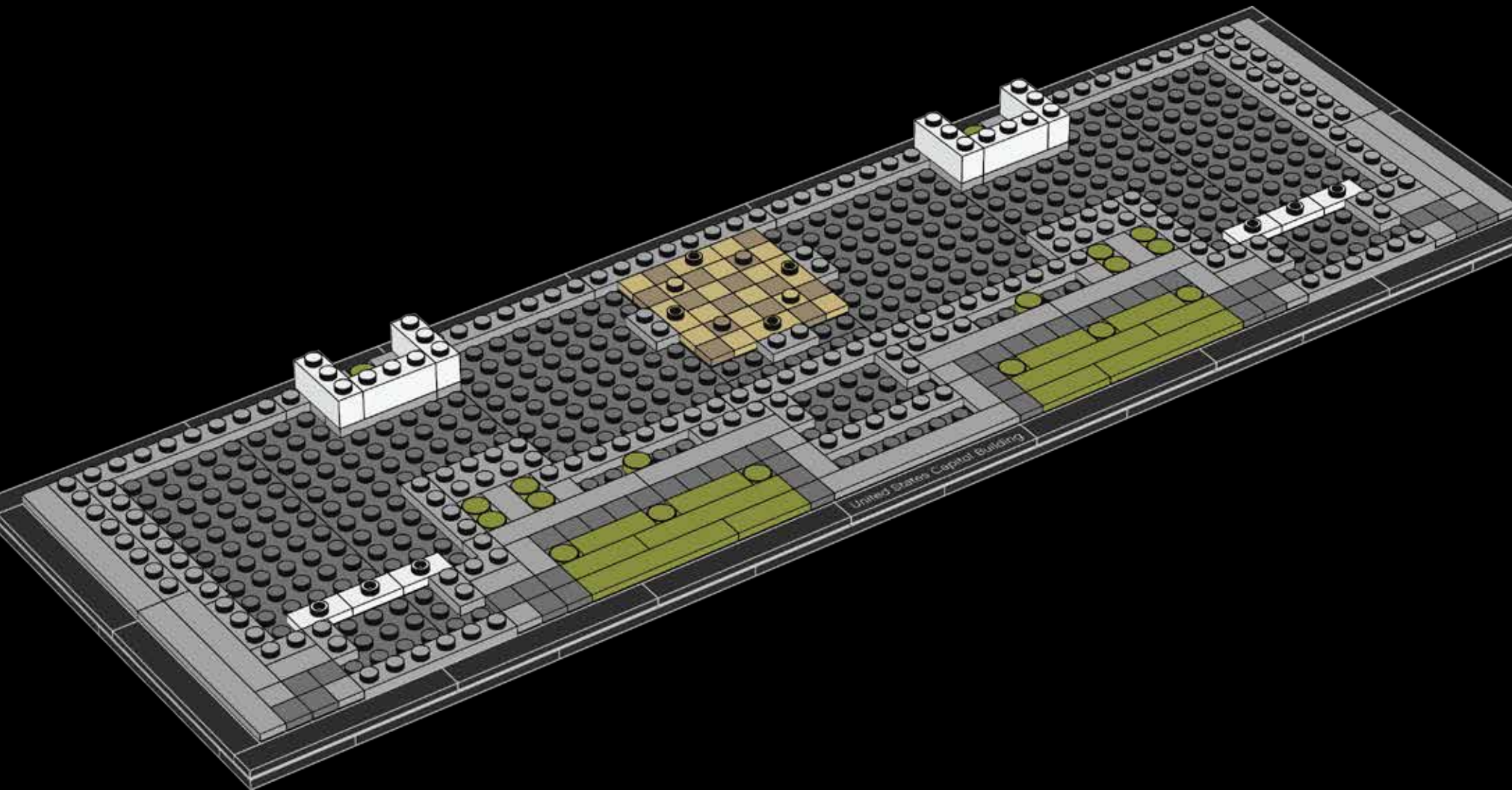

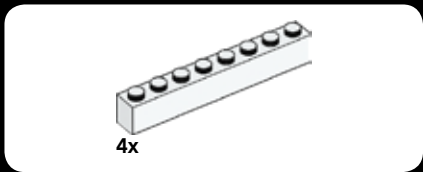

35

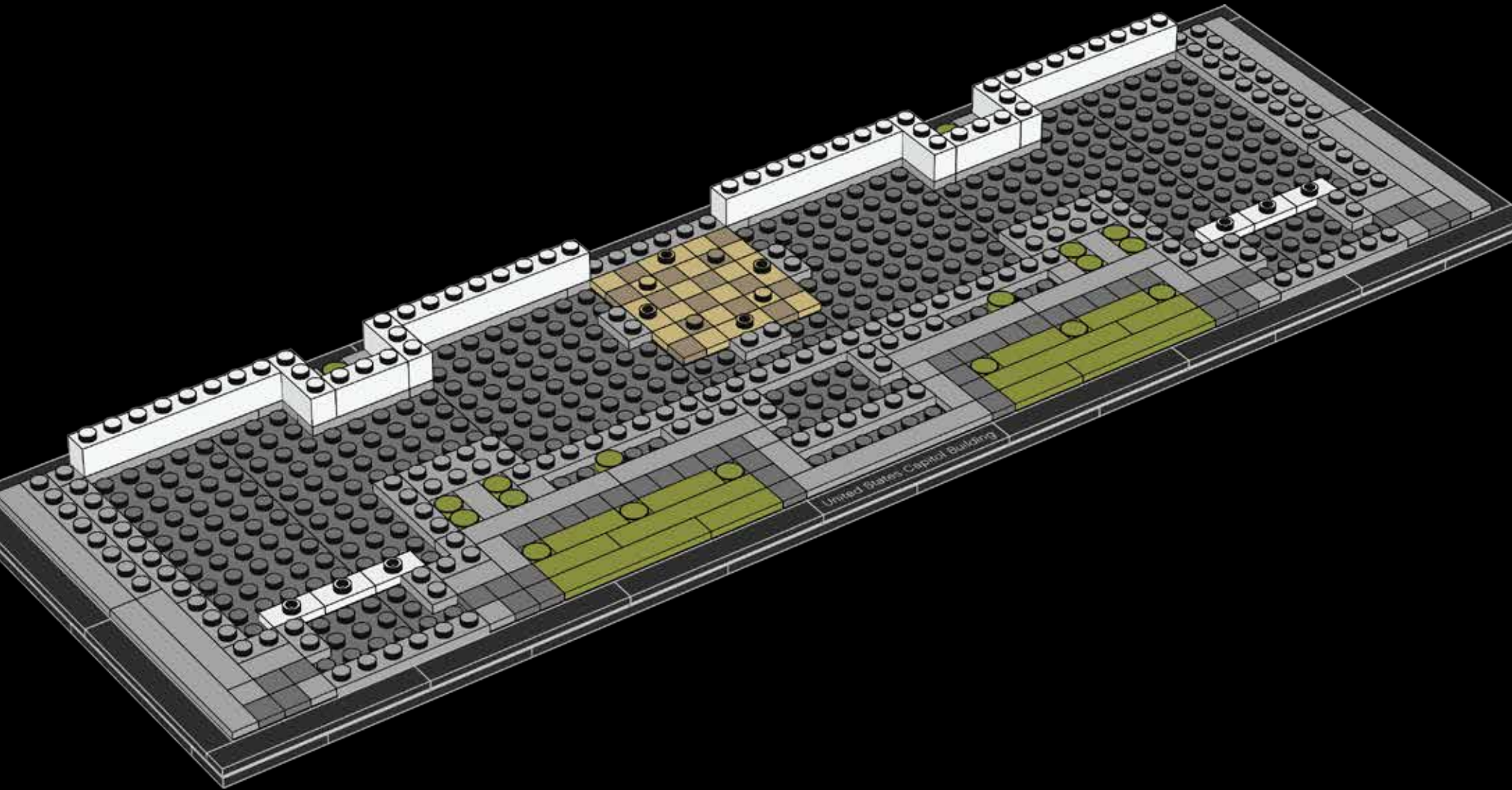



8x

36

The building contains approximately 540 rooms, has 658 windows and approximately 850 doorways.

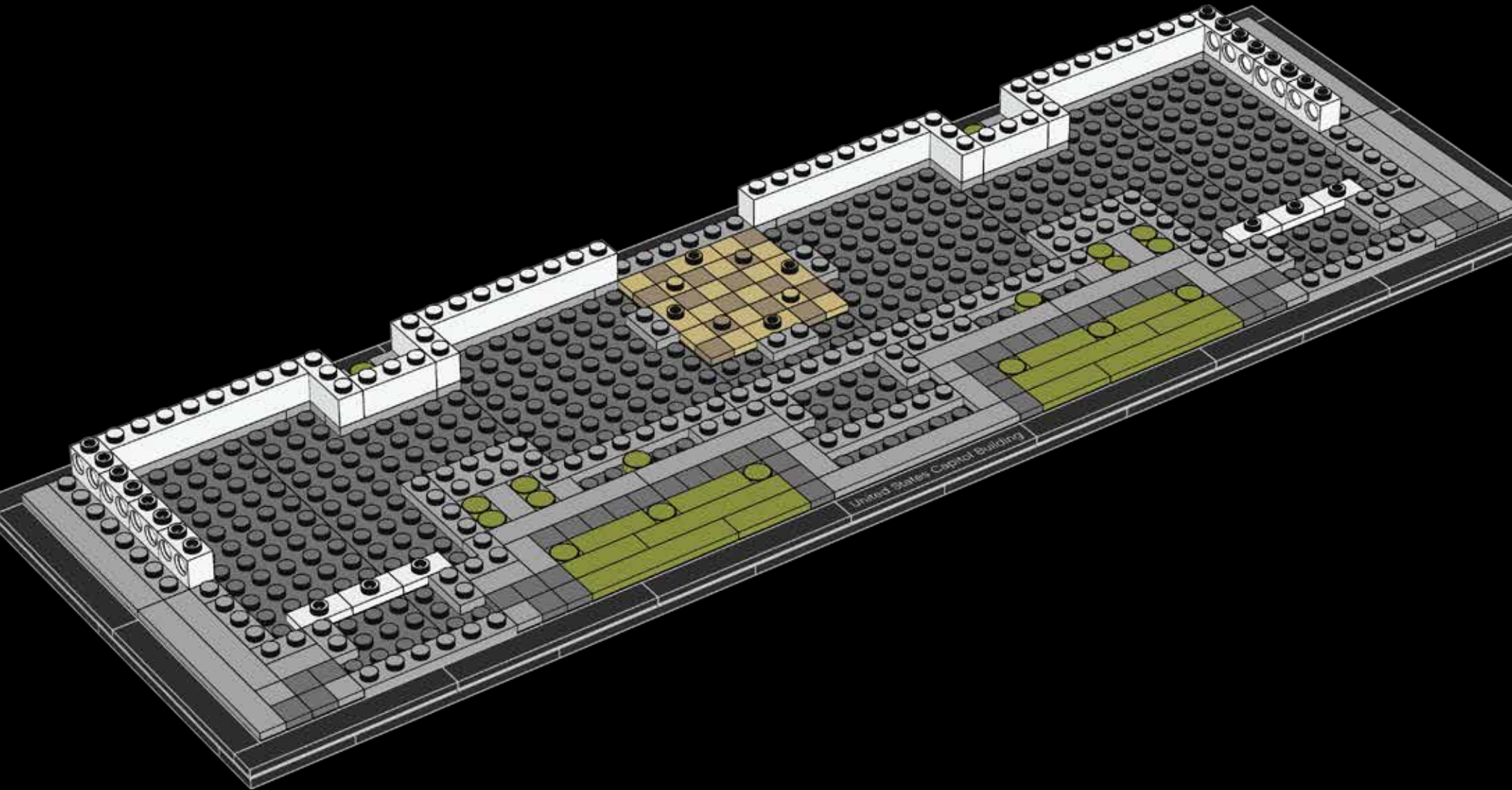



6x



37

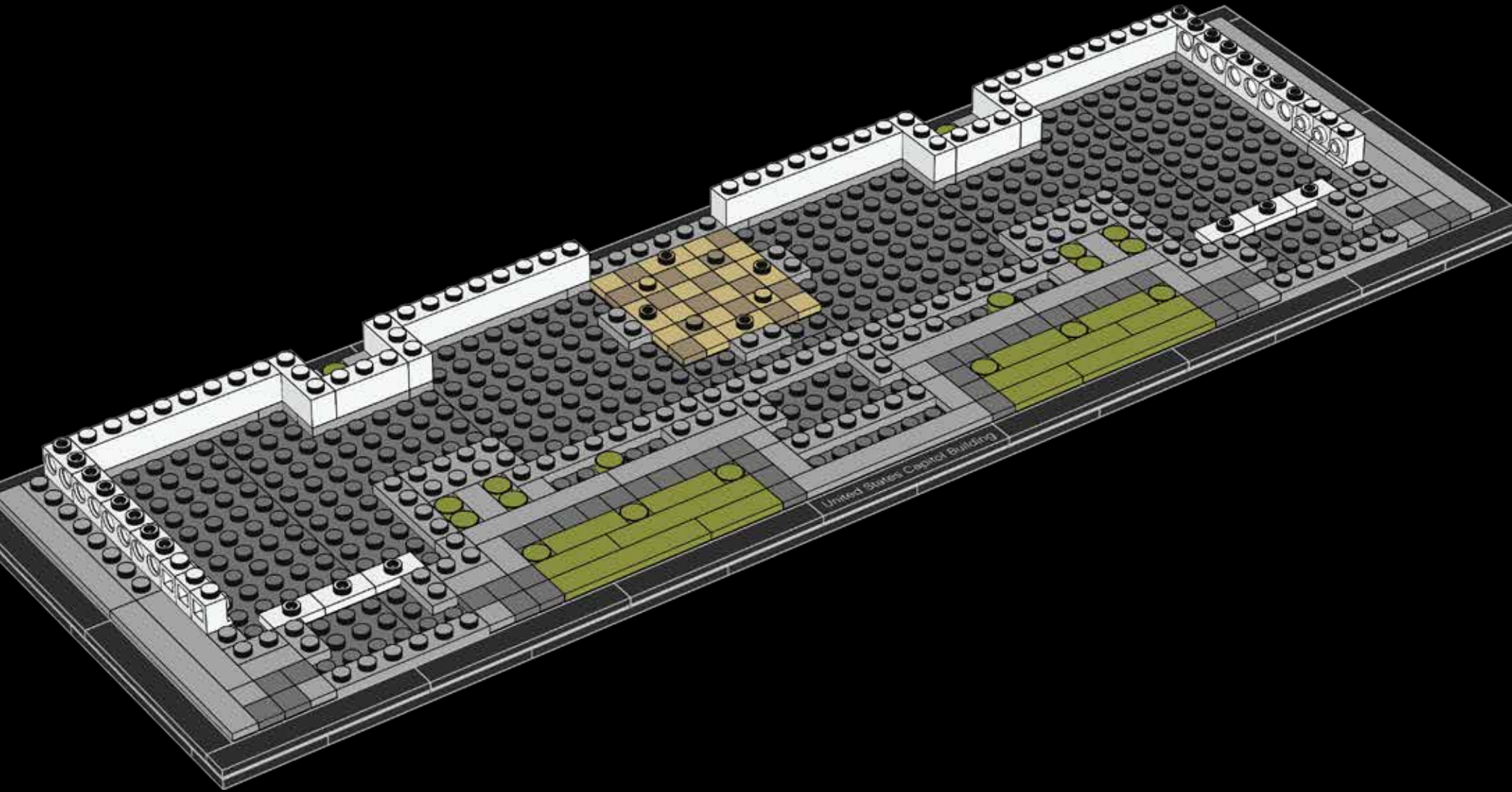





2x



# 38

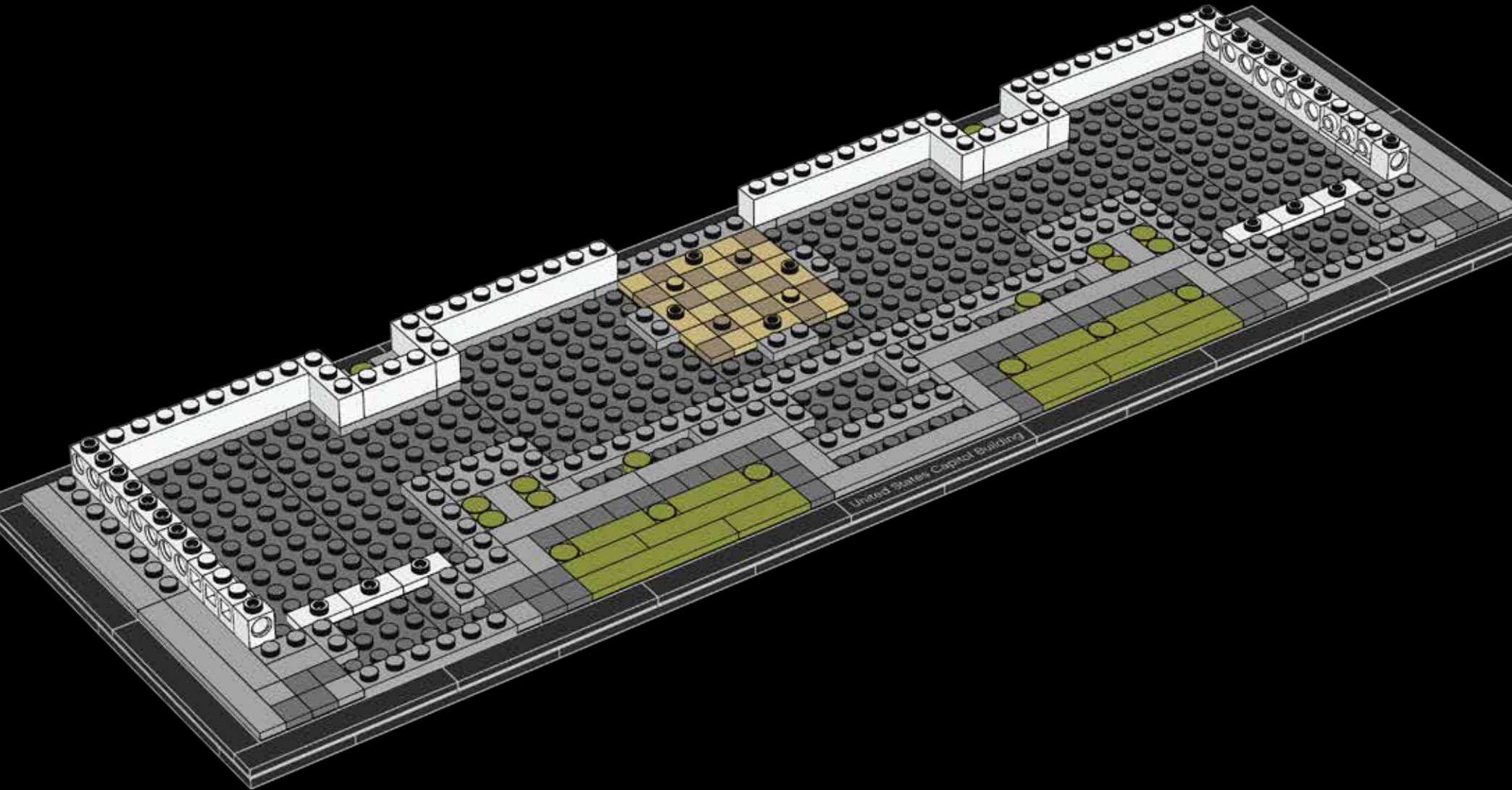



4x



39

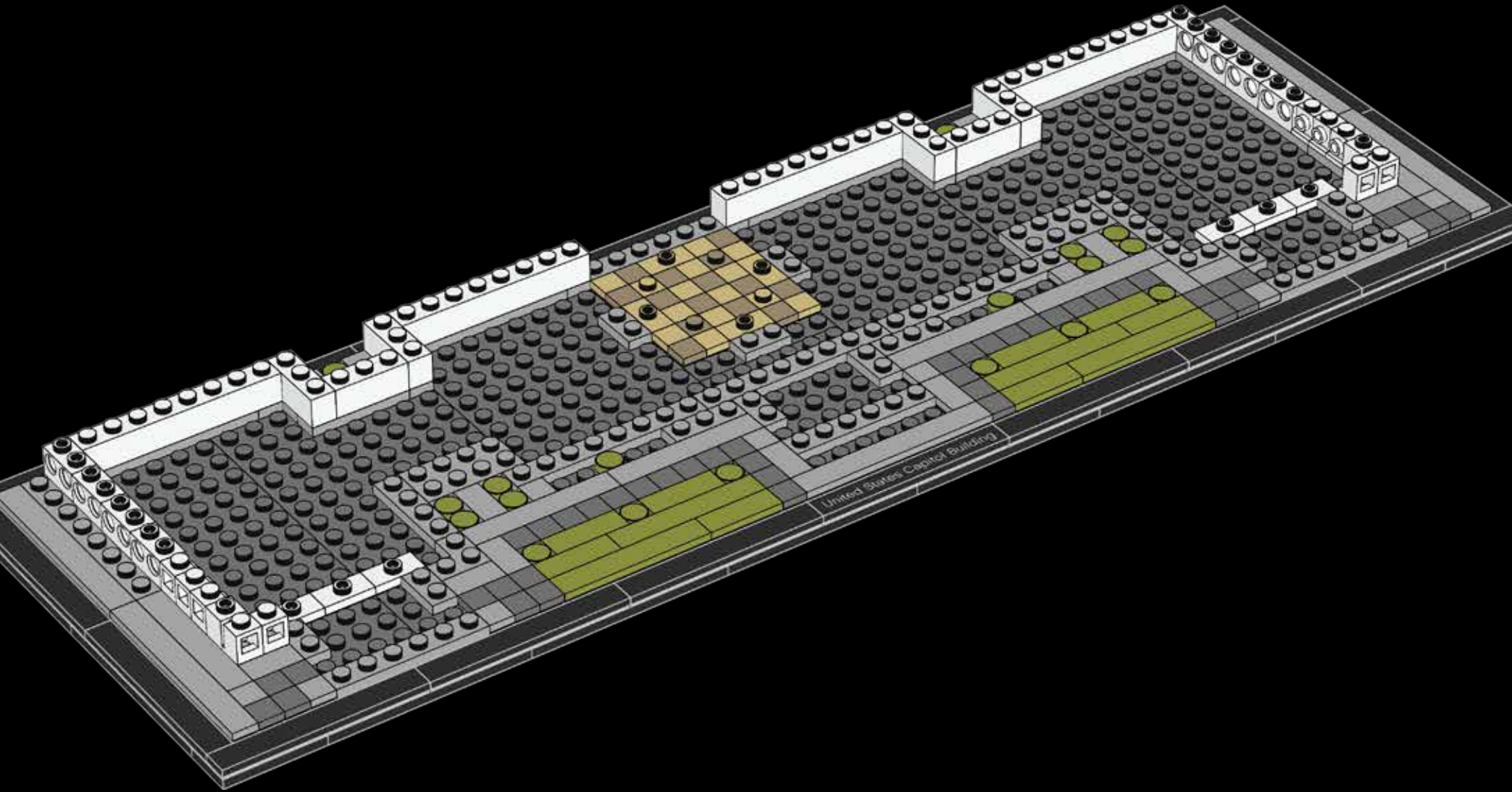



2x

40

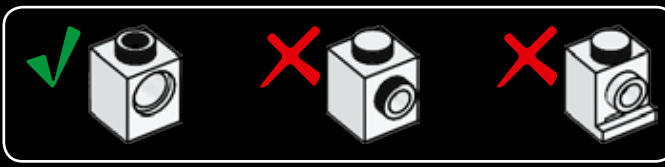



2x



41

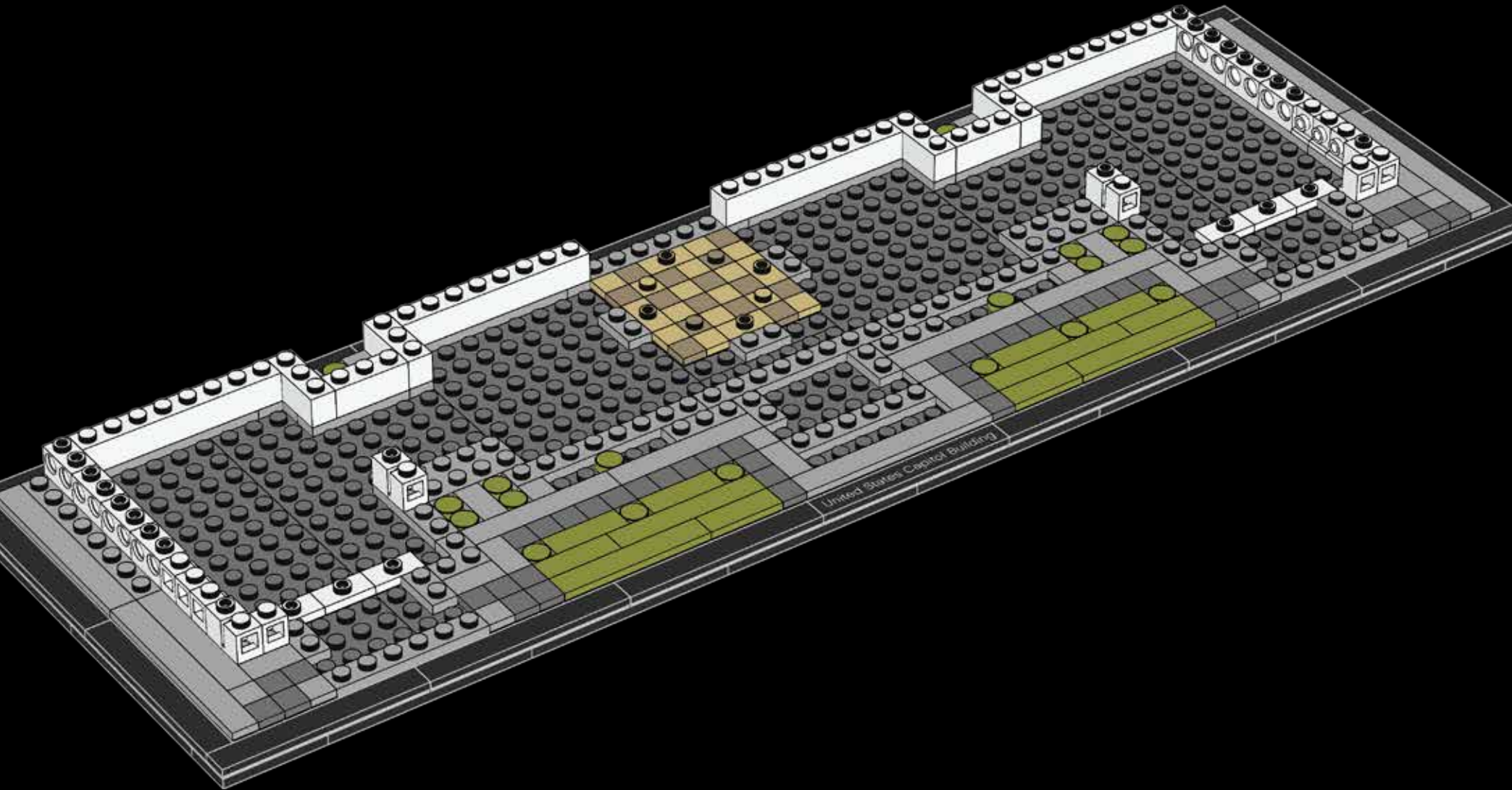



4x

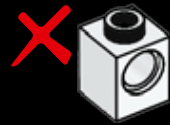
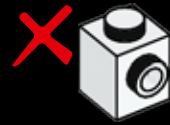

42

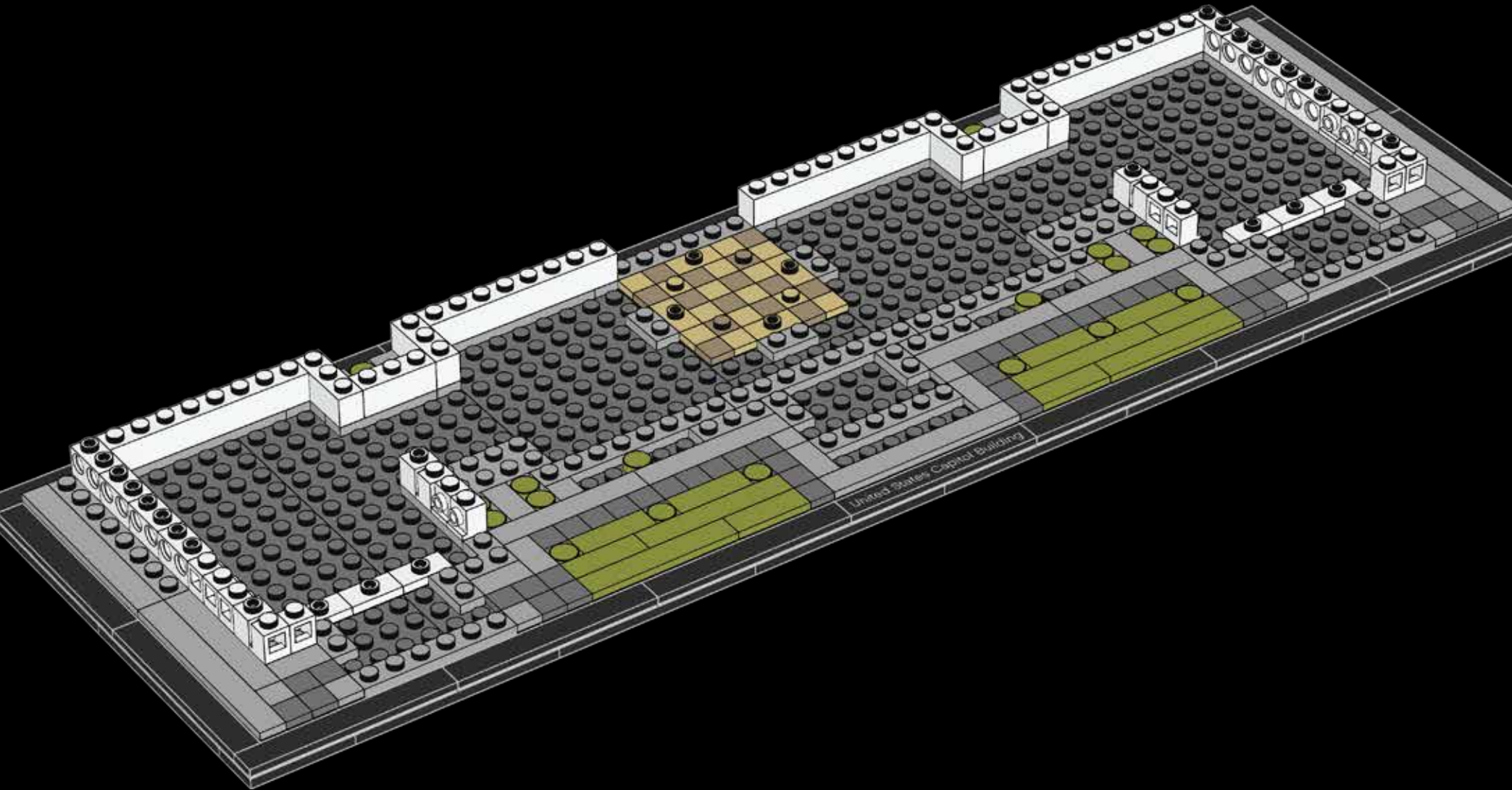



2x



43

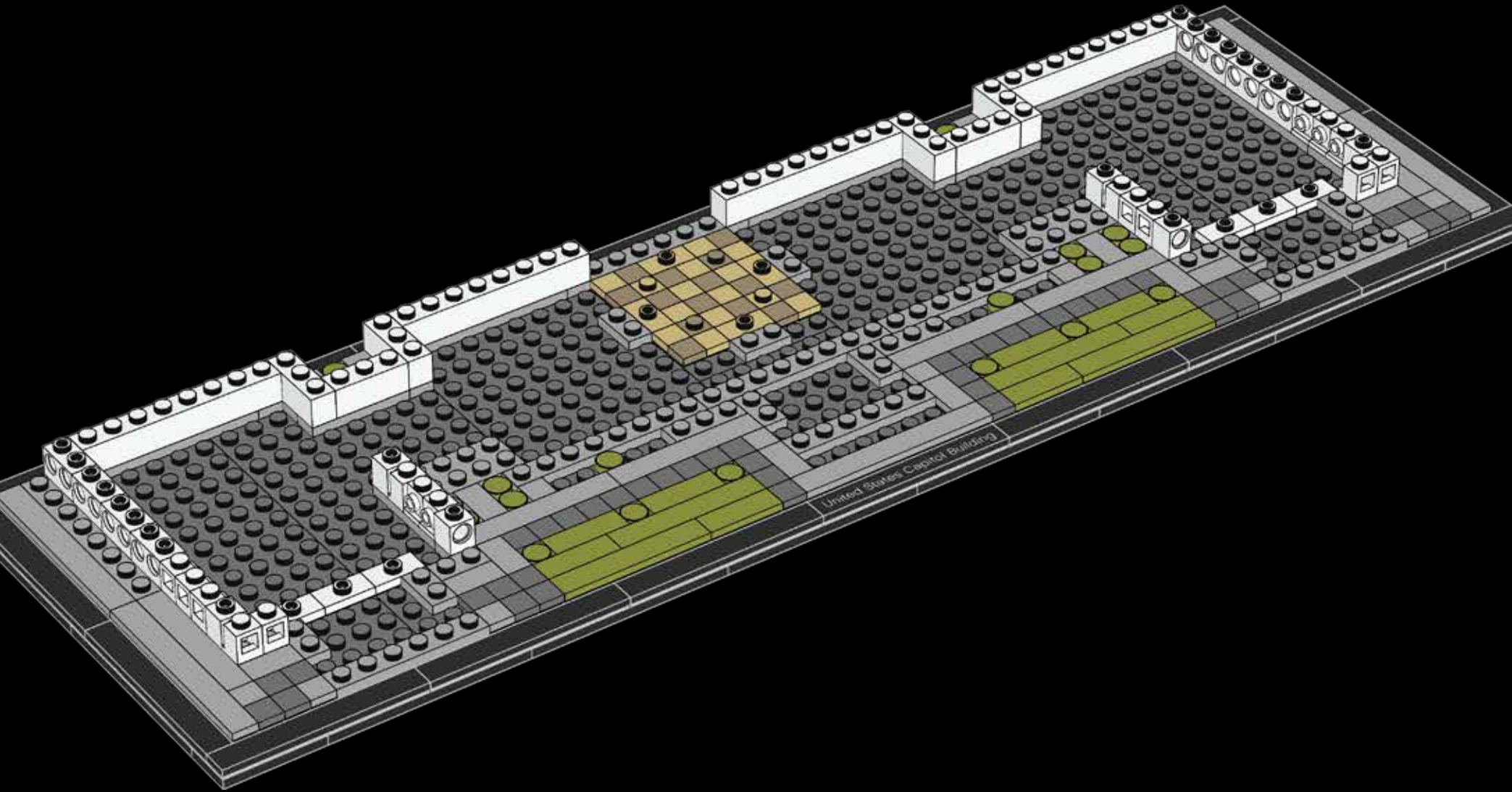



4x



44





4x

45

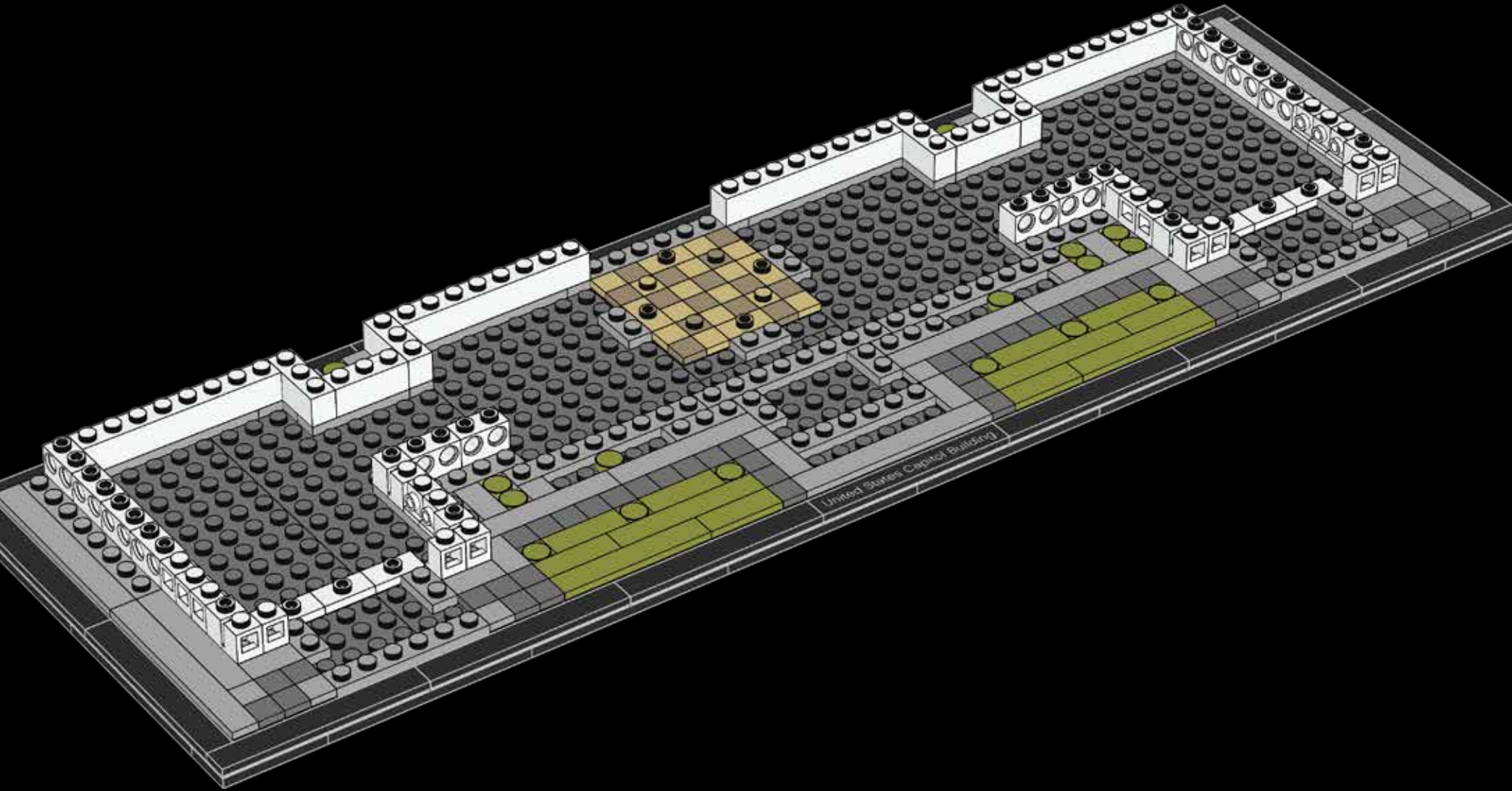





6x

46

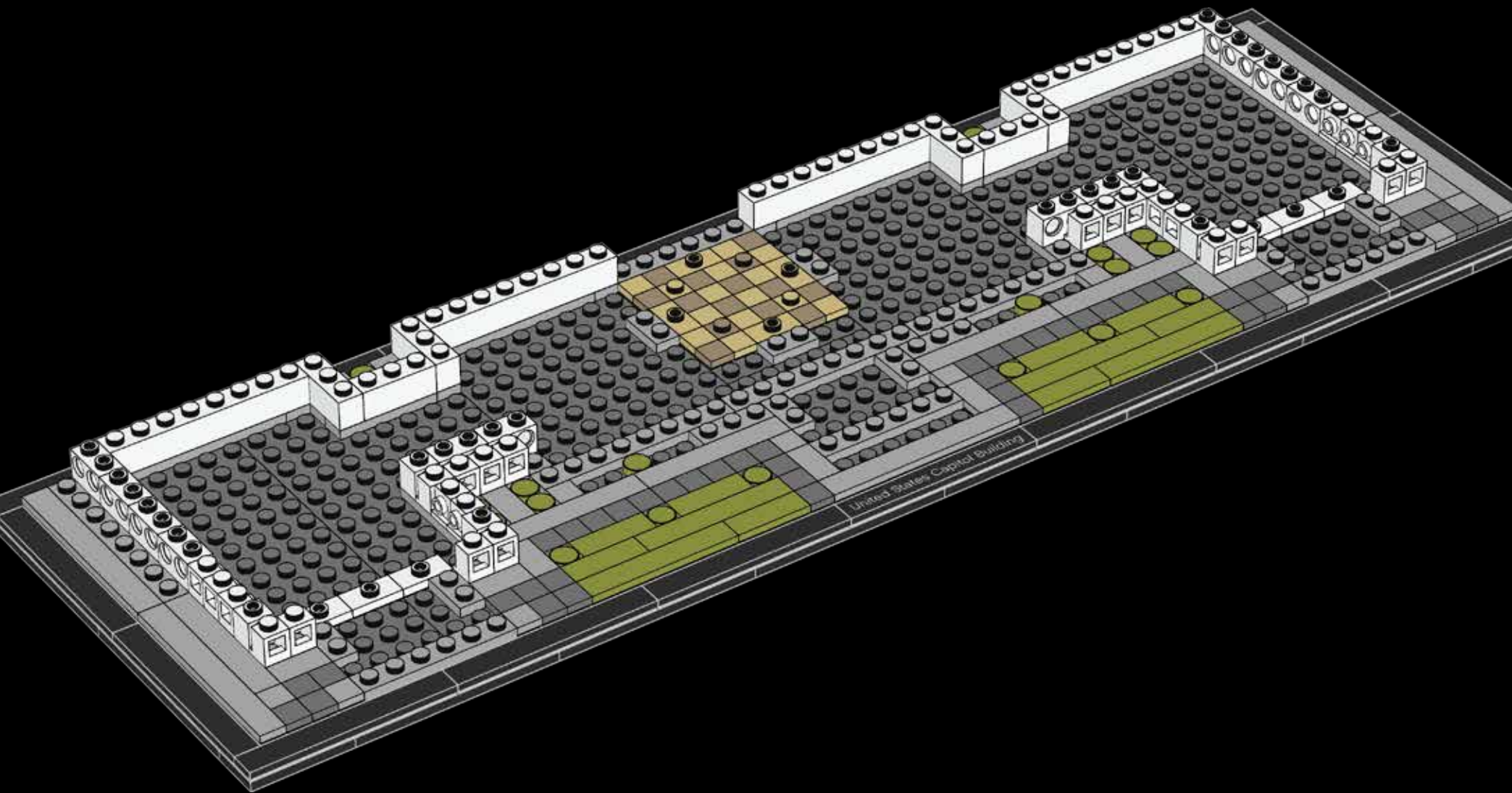
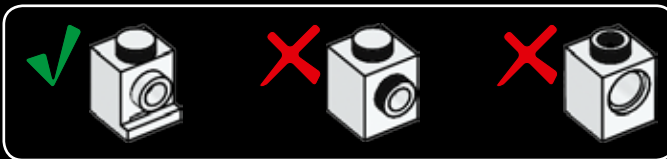



2x



47

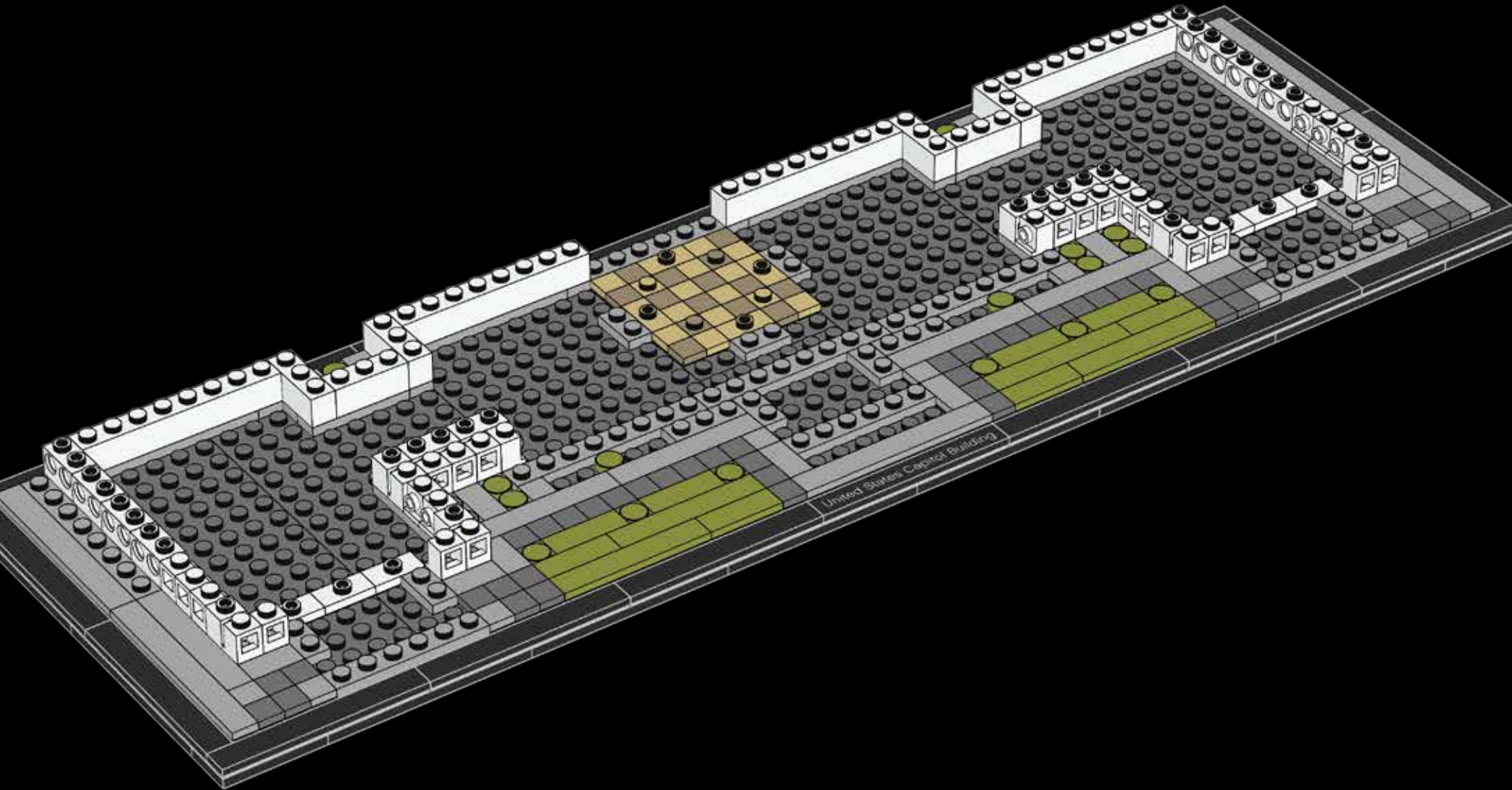



10x

48

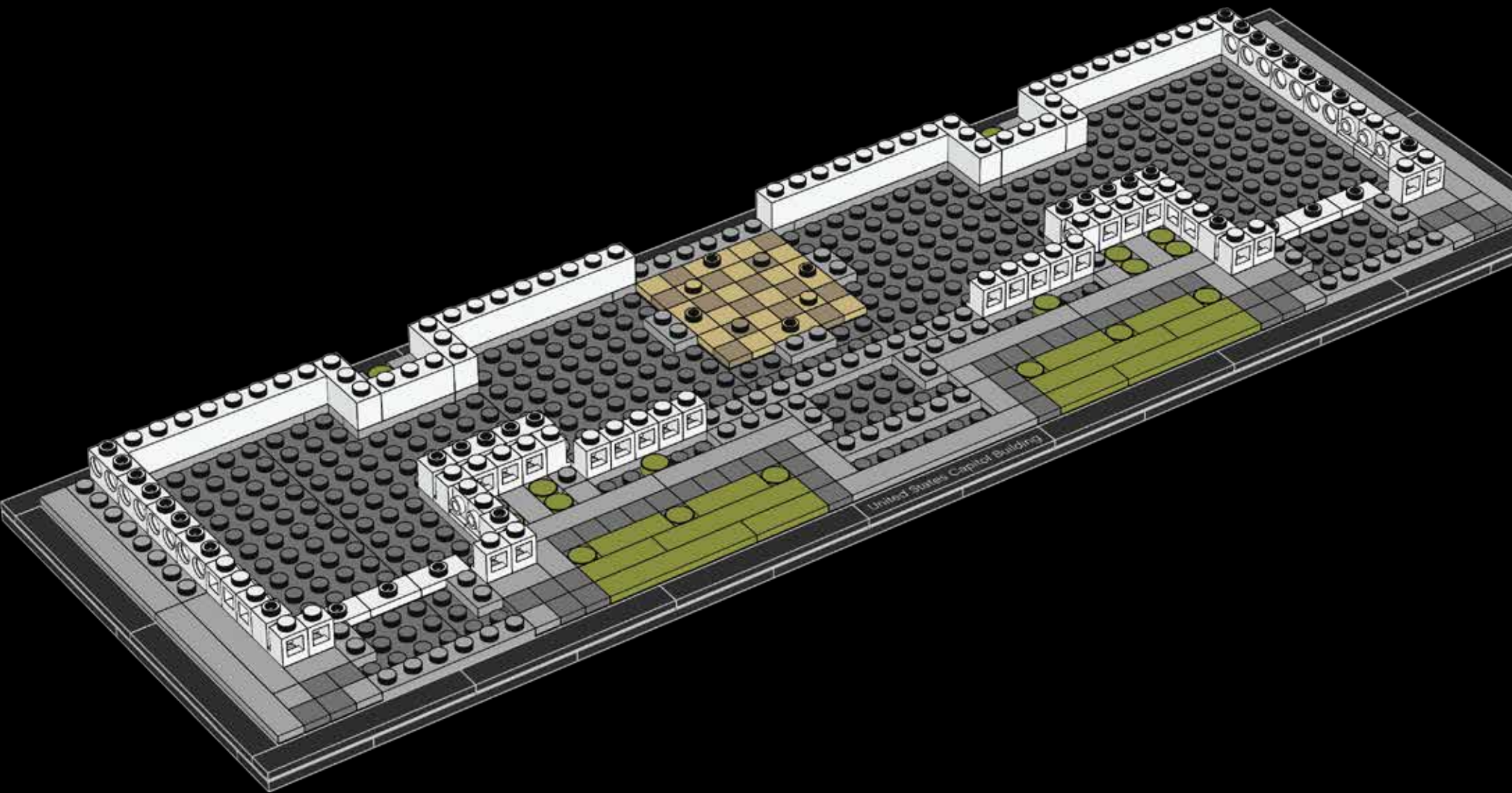
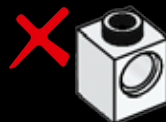
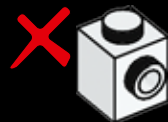



8x

49

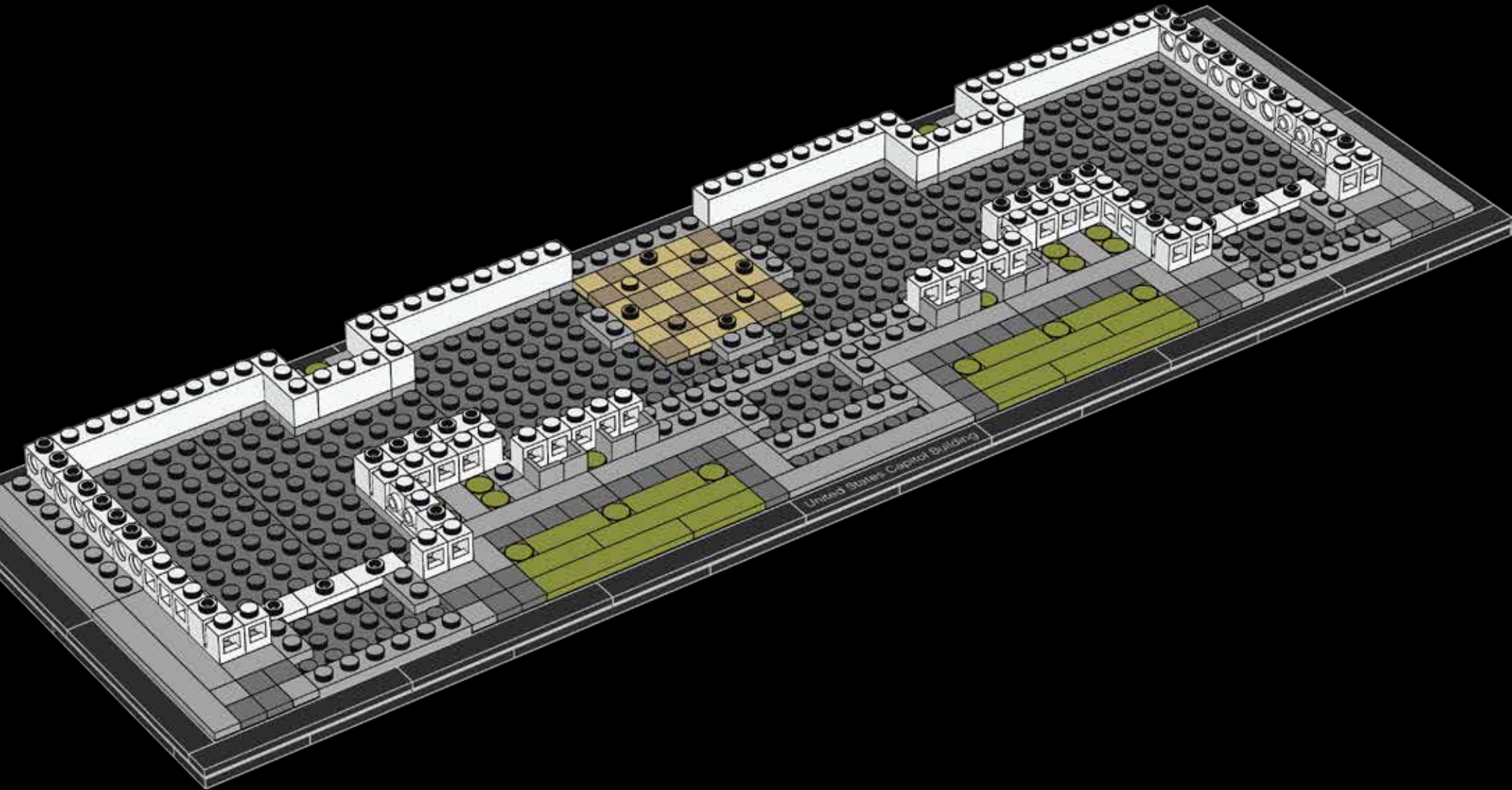



2x



2x



# 50

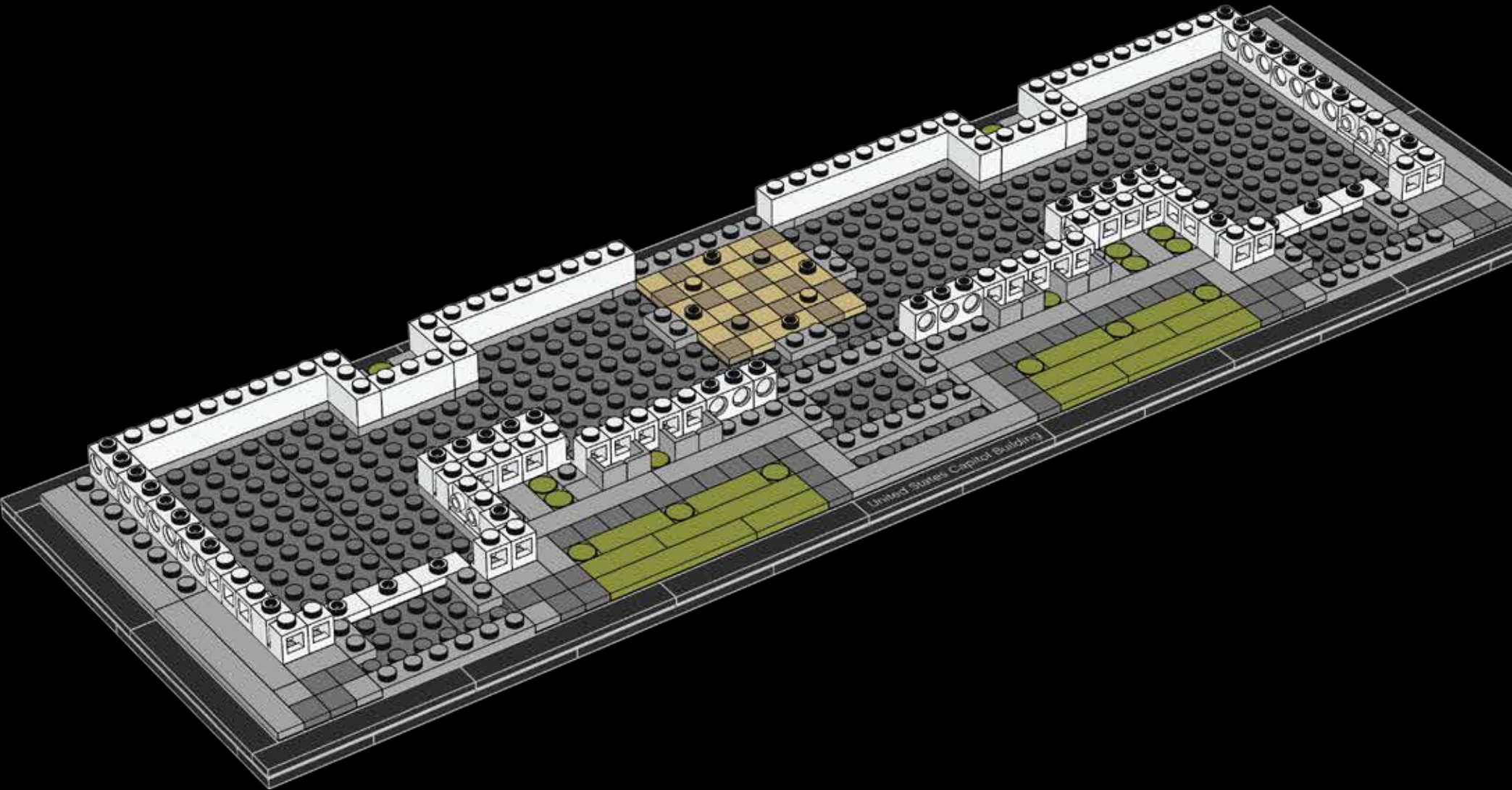

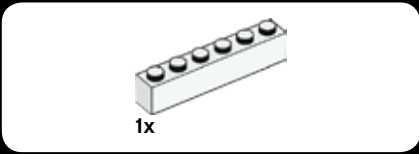

51

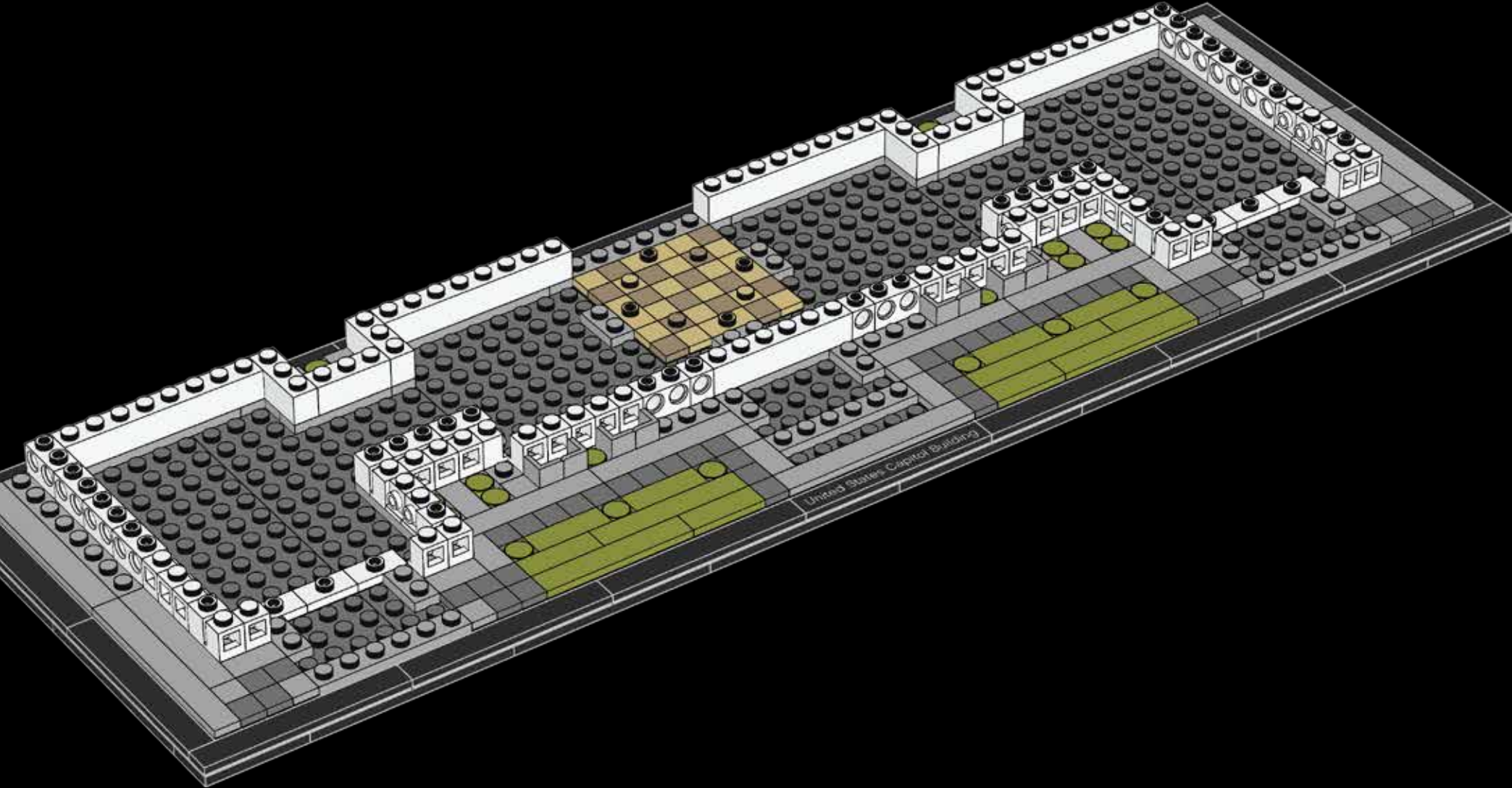



6x

52

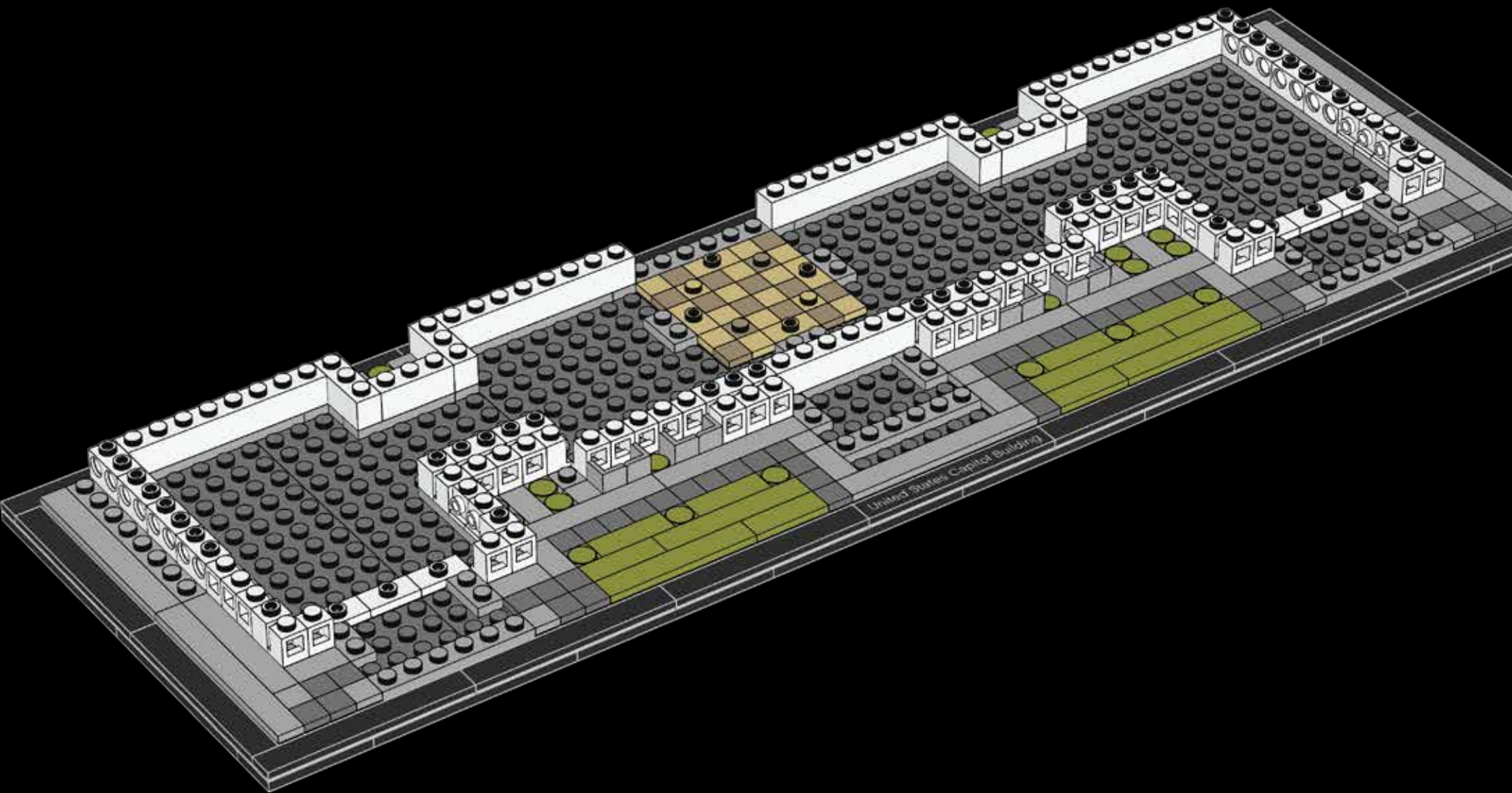
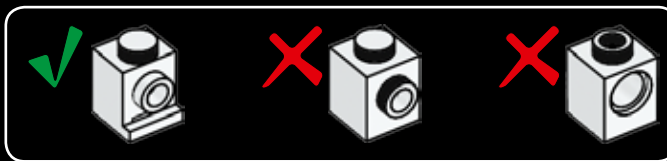



3x

53

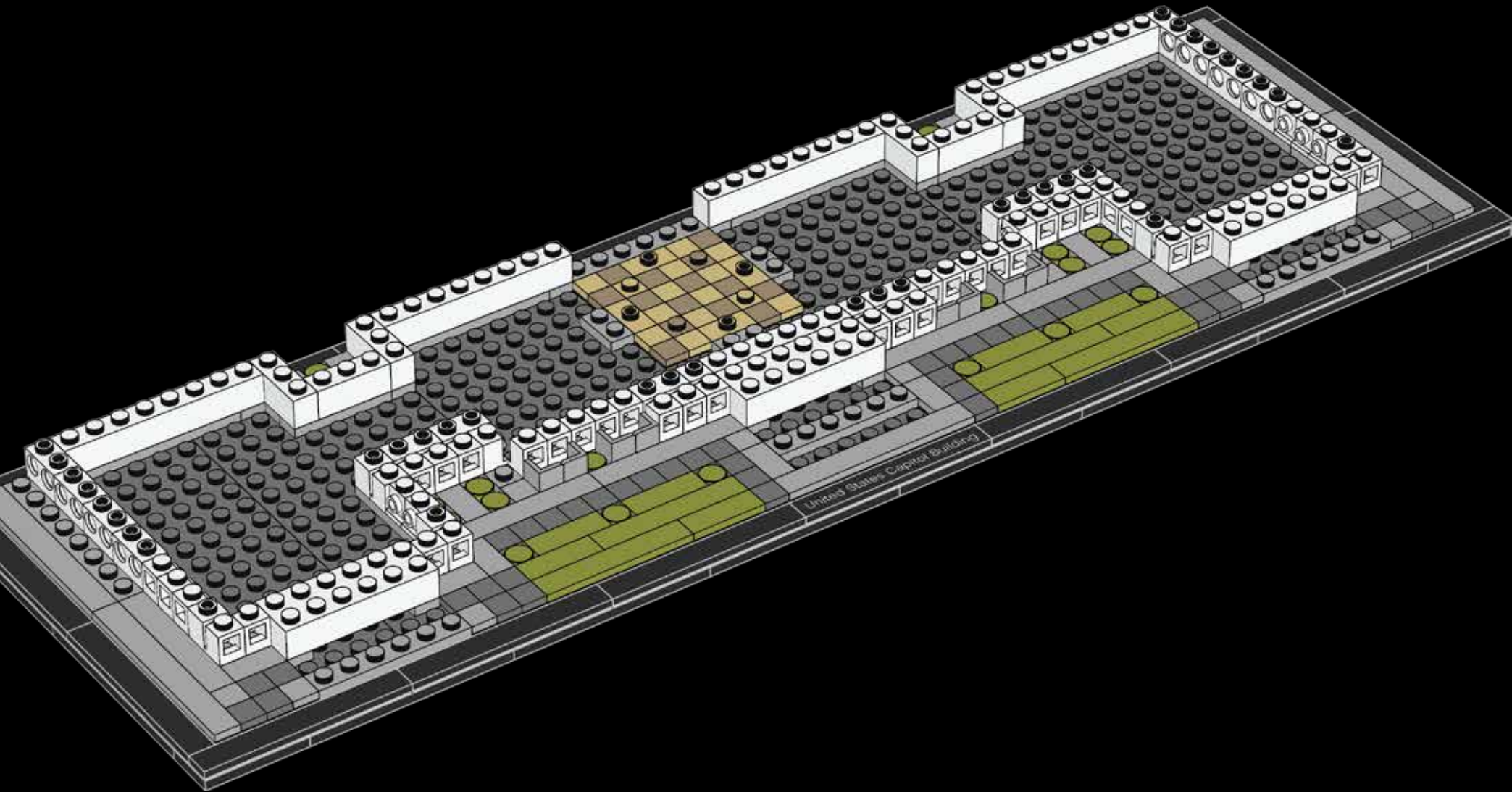



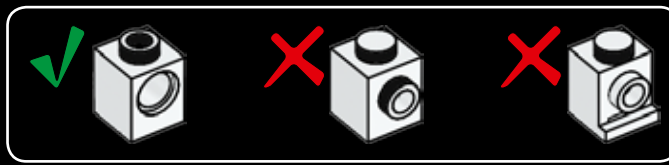

54

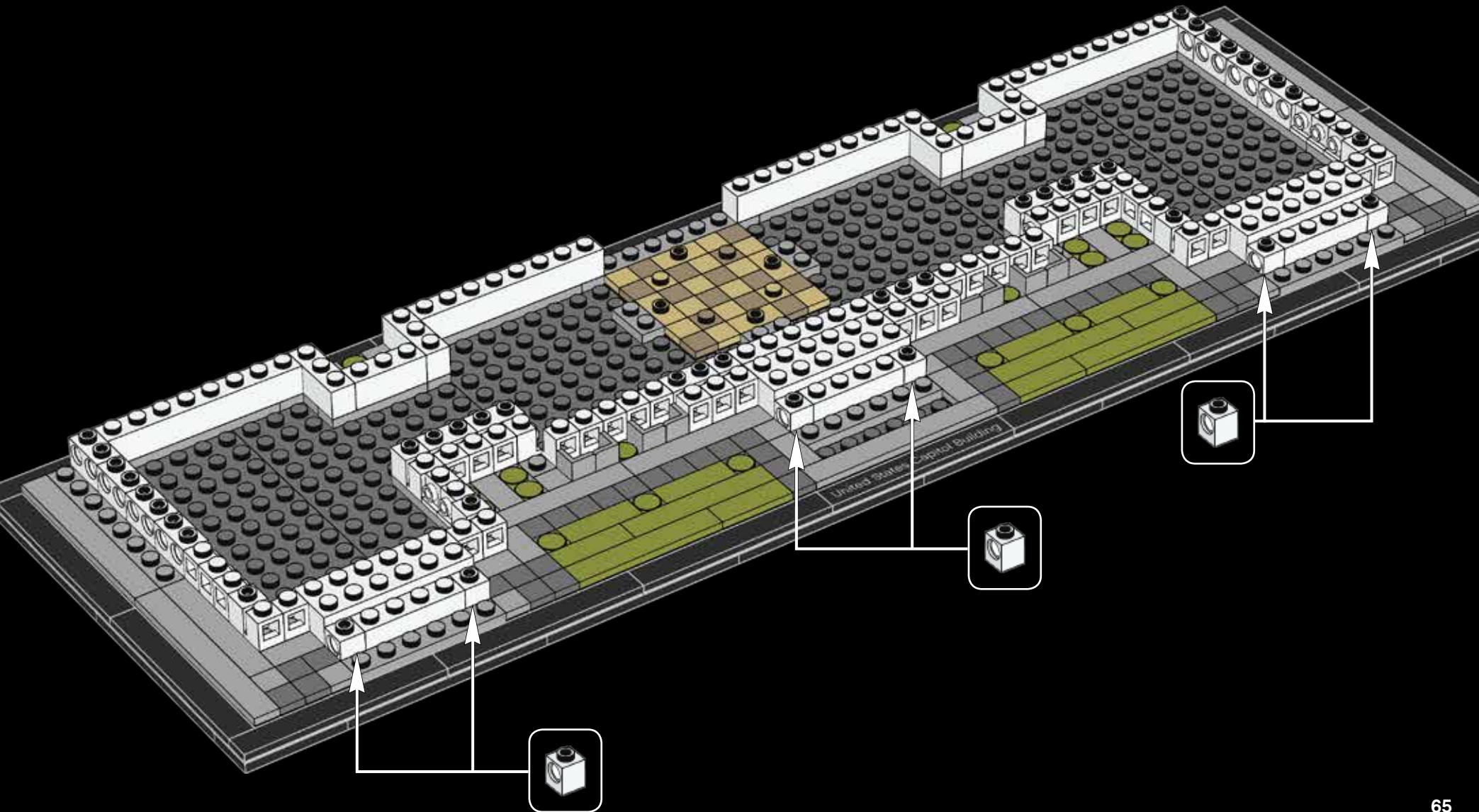



2x



2x

55

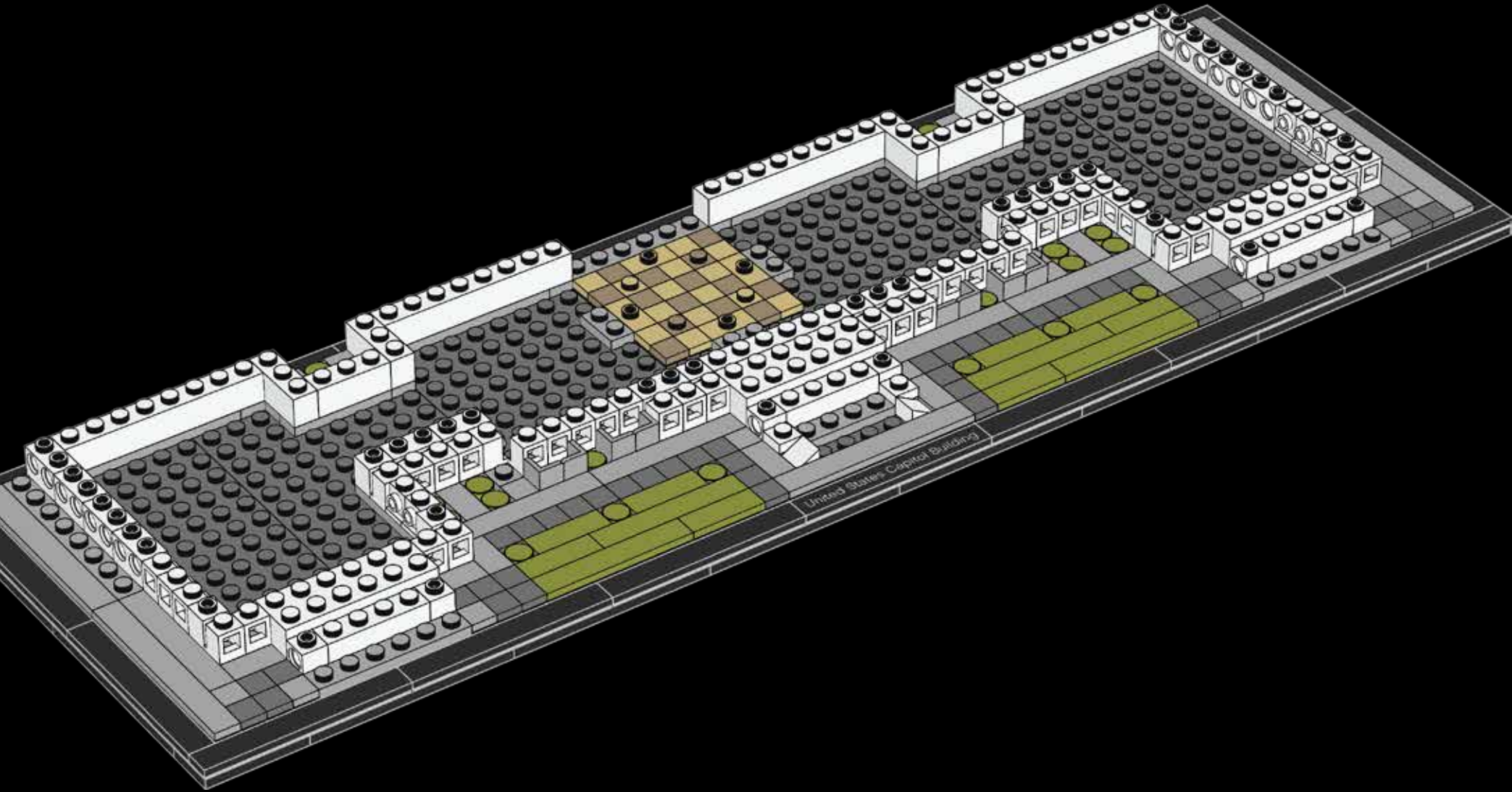



4x

56

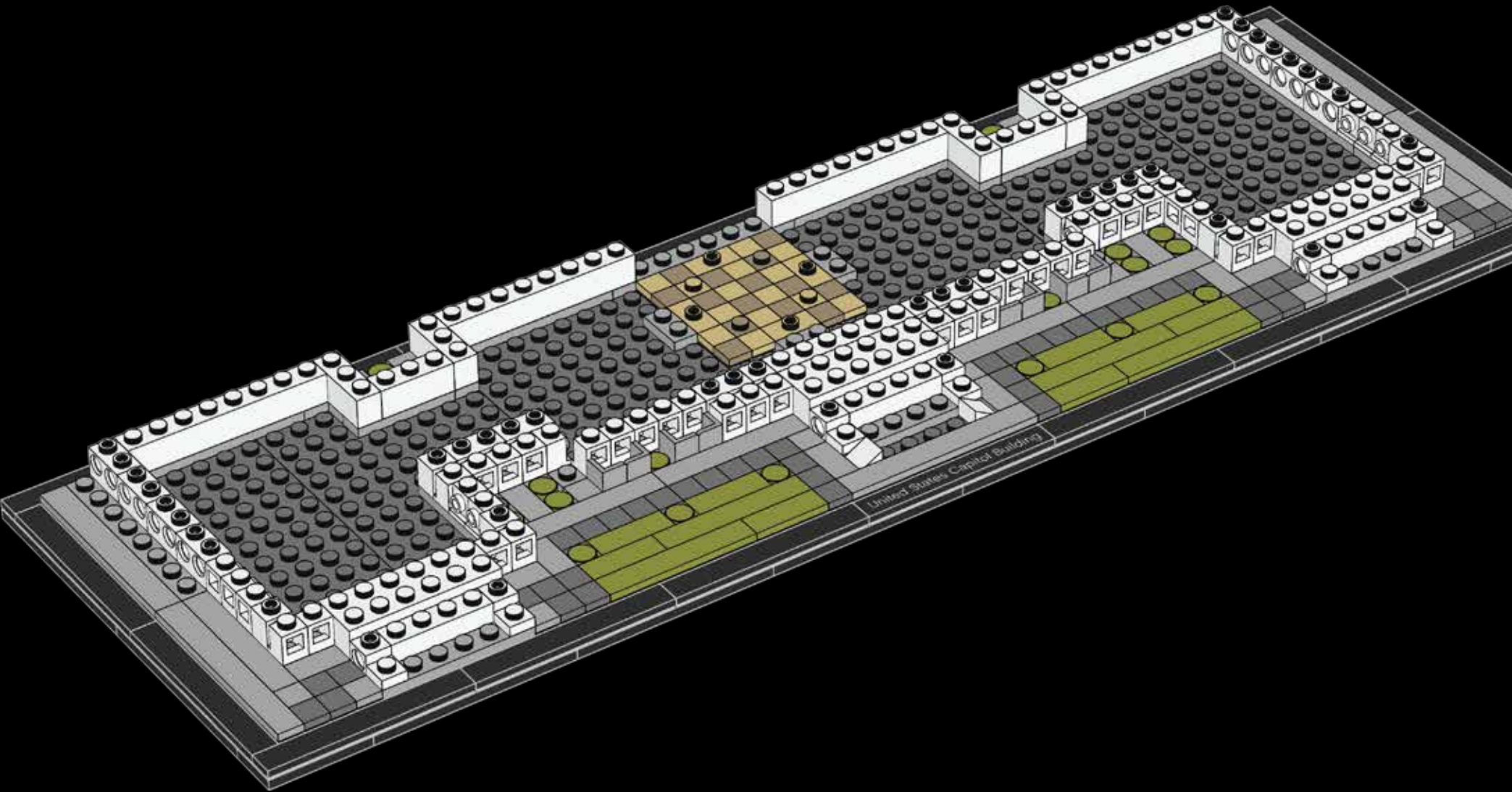



6x



6x

57

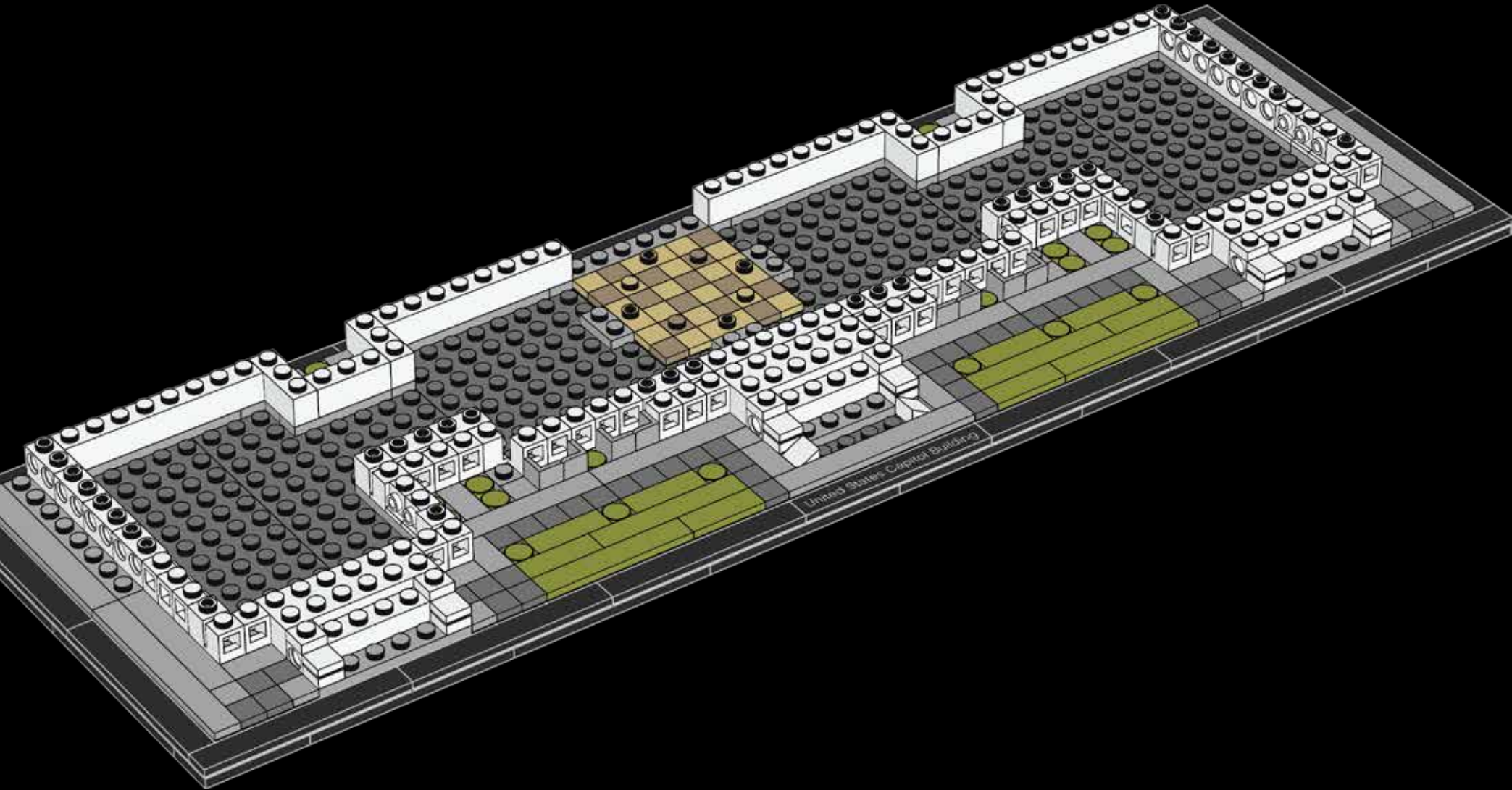



14x

58

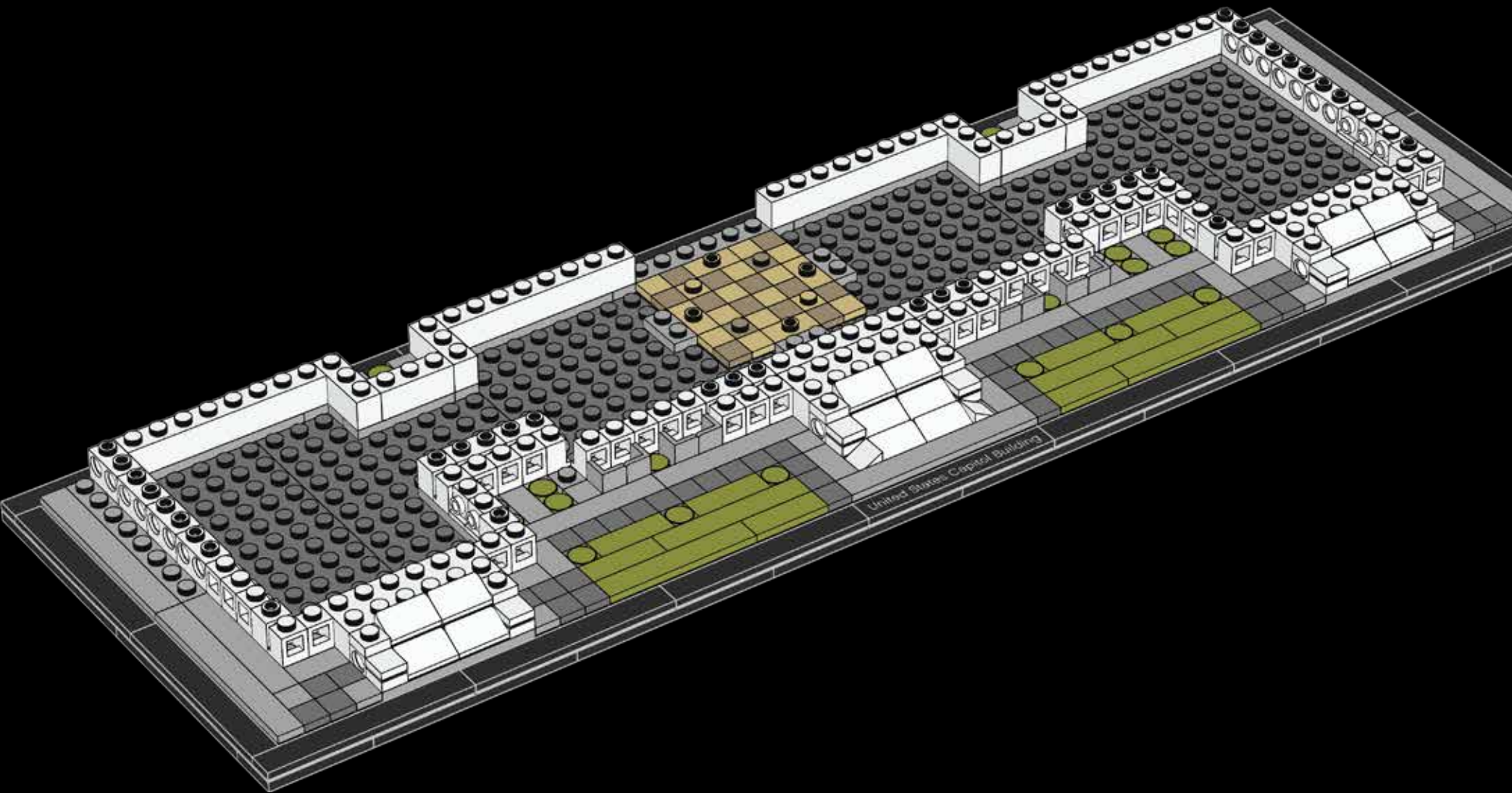



6x



6x

59

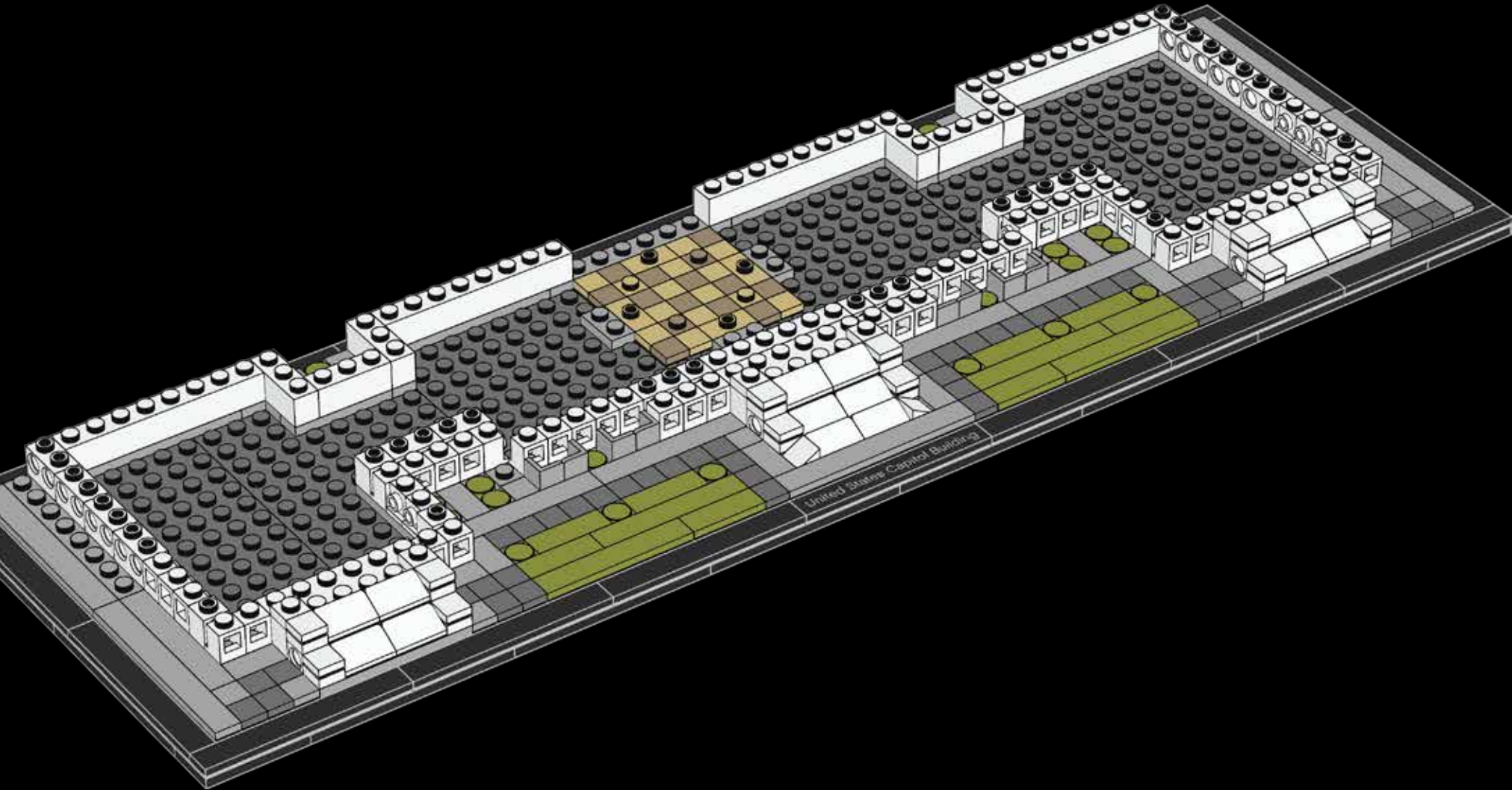



2x



4x

# 60





16x



61

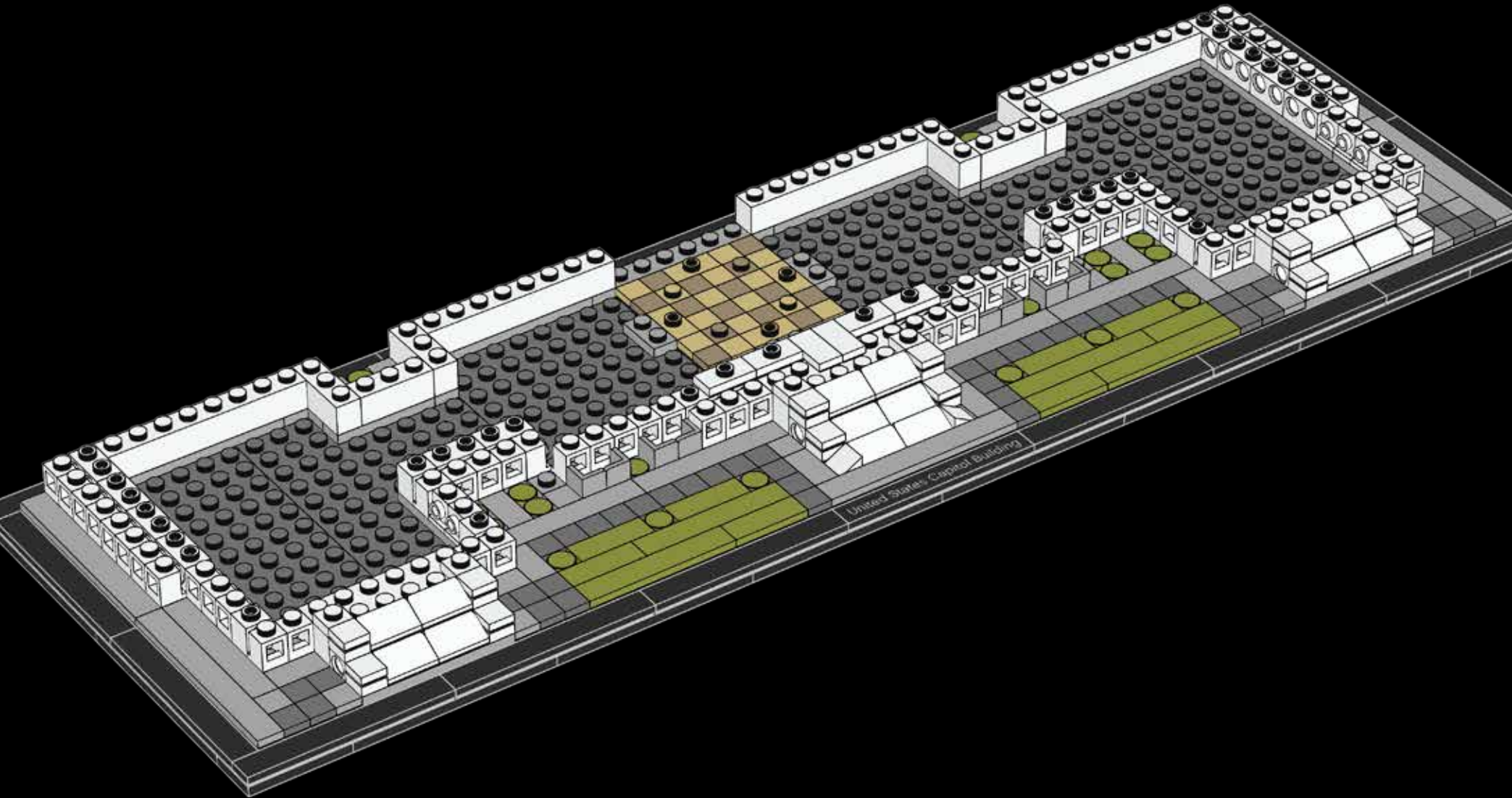





2x

62

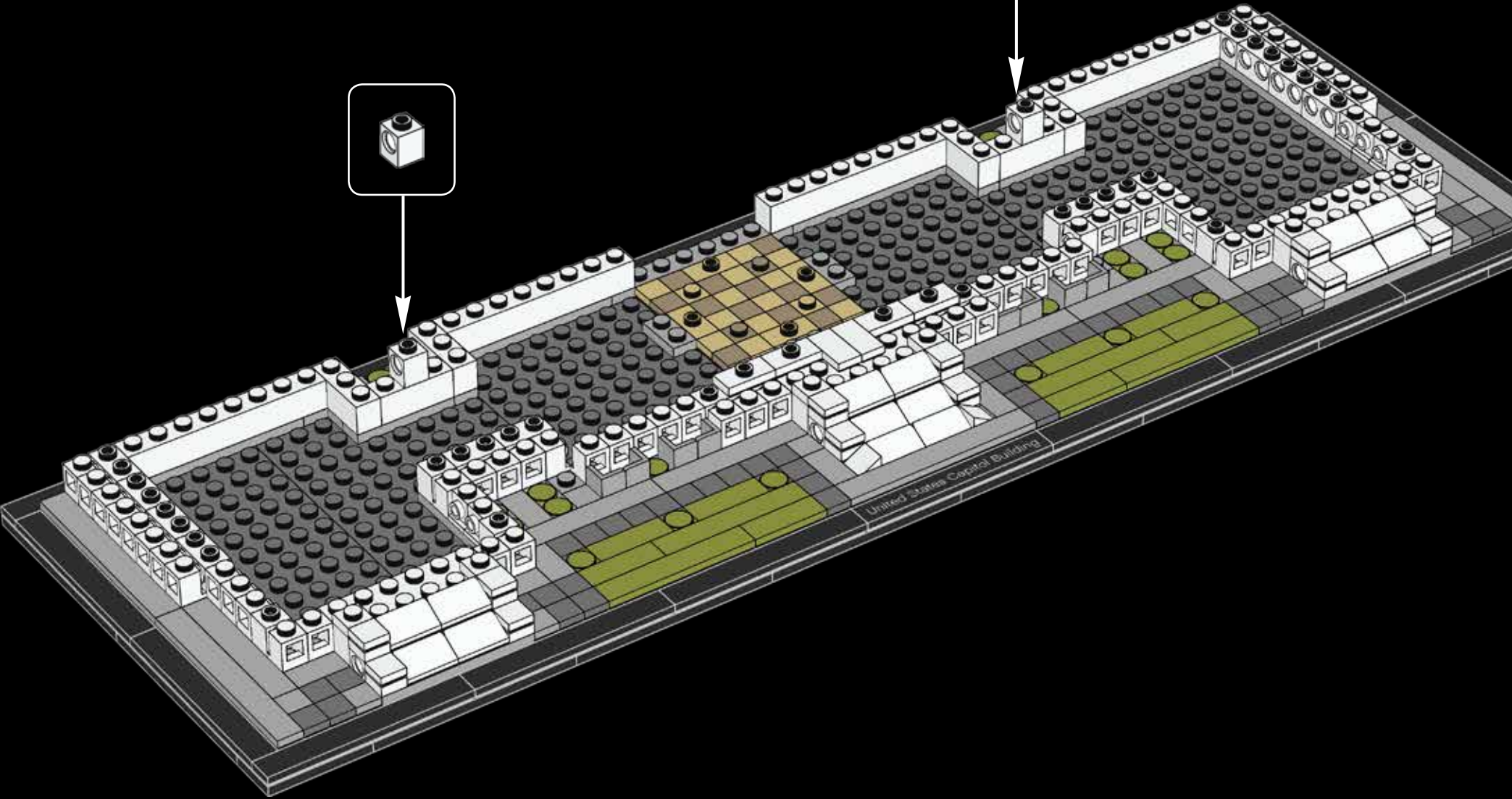
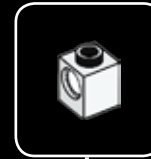
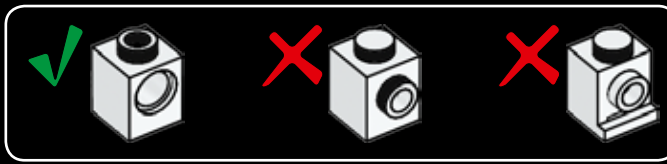

United States Capitol Building



4x

63

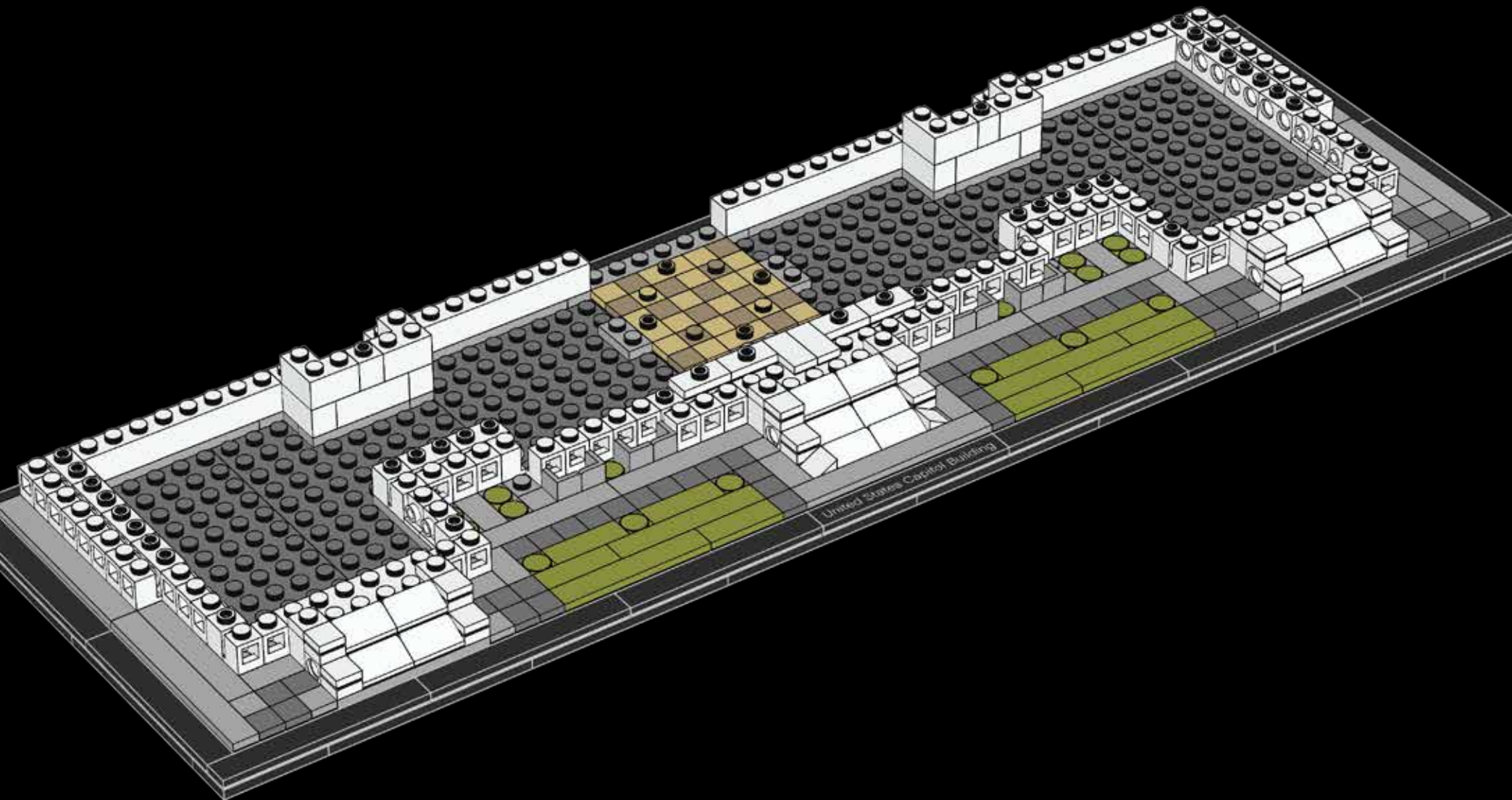

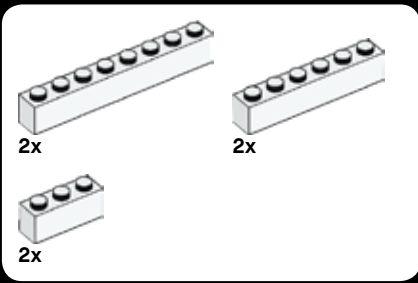

64





2x

65

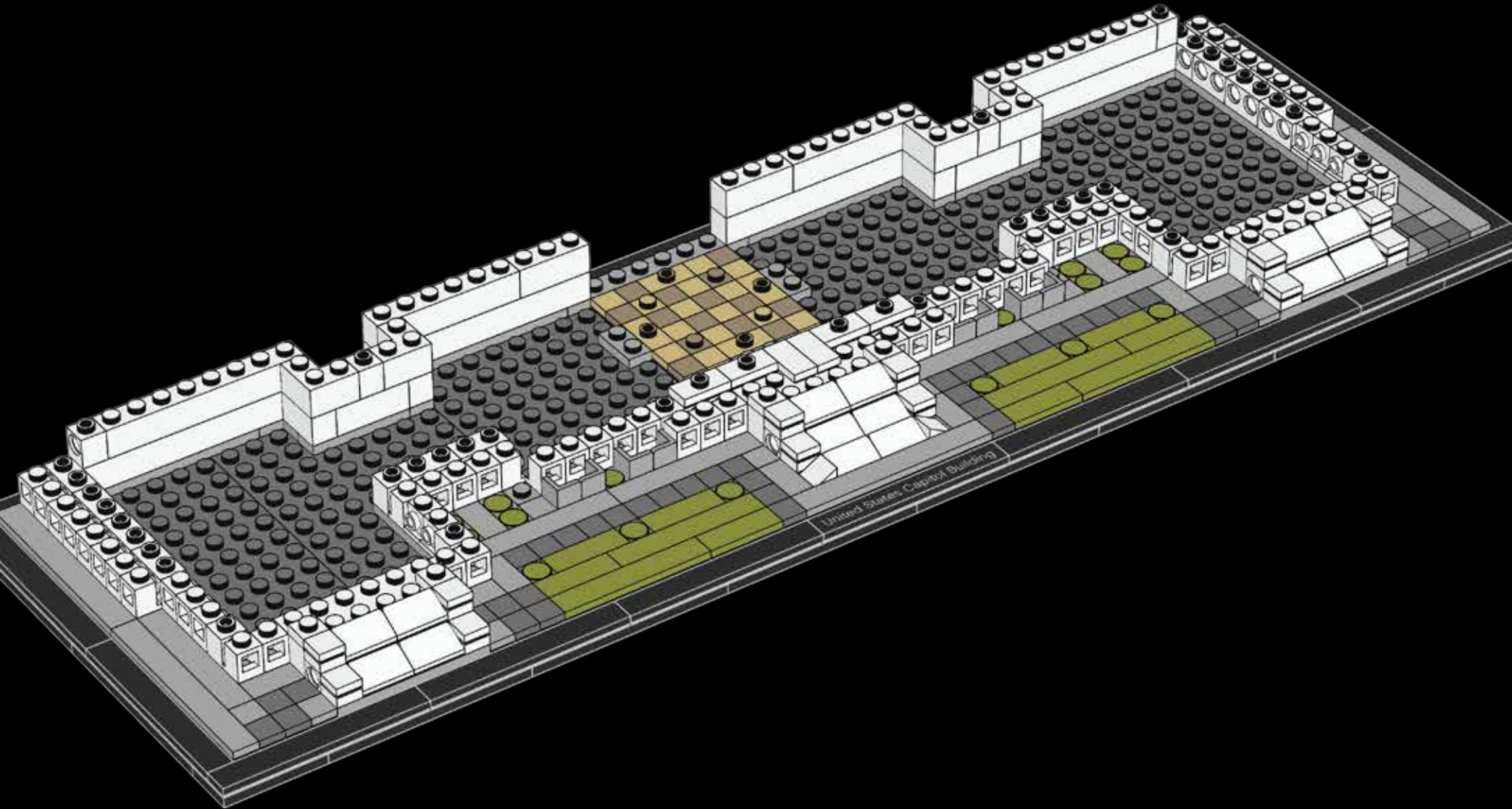



6x

66

There are 108 windows in the dome above the rotunda.

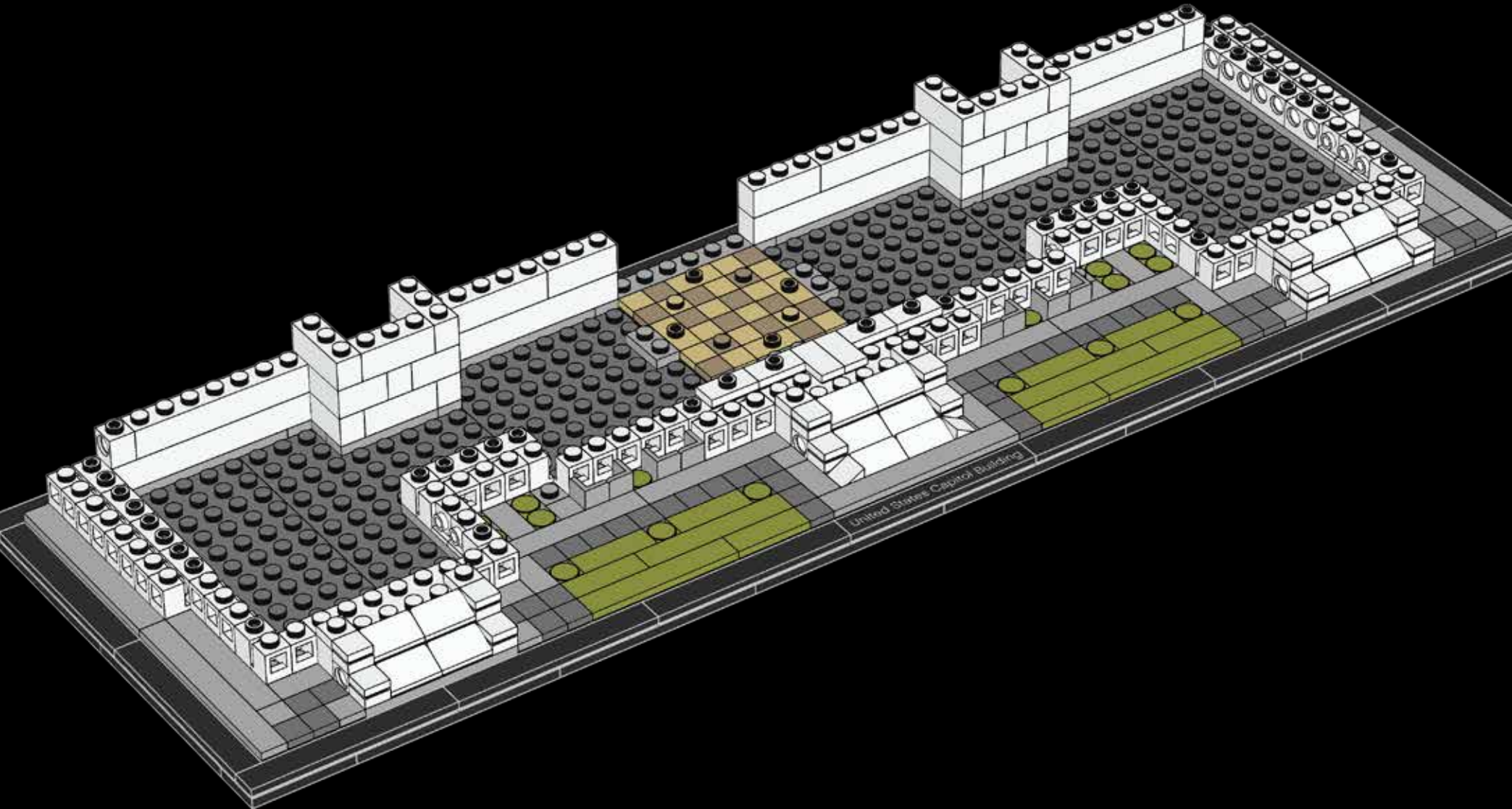

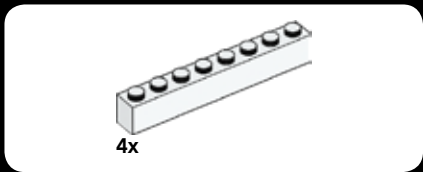

67

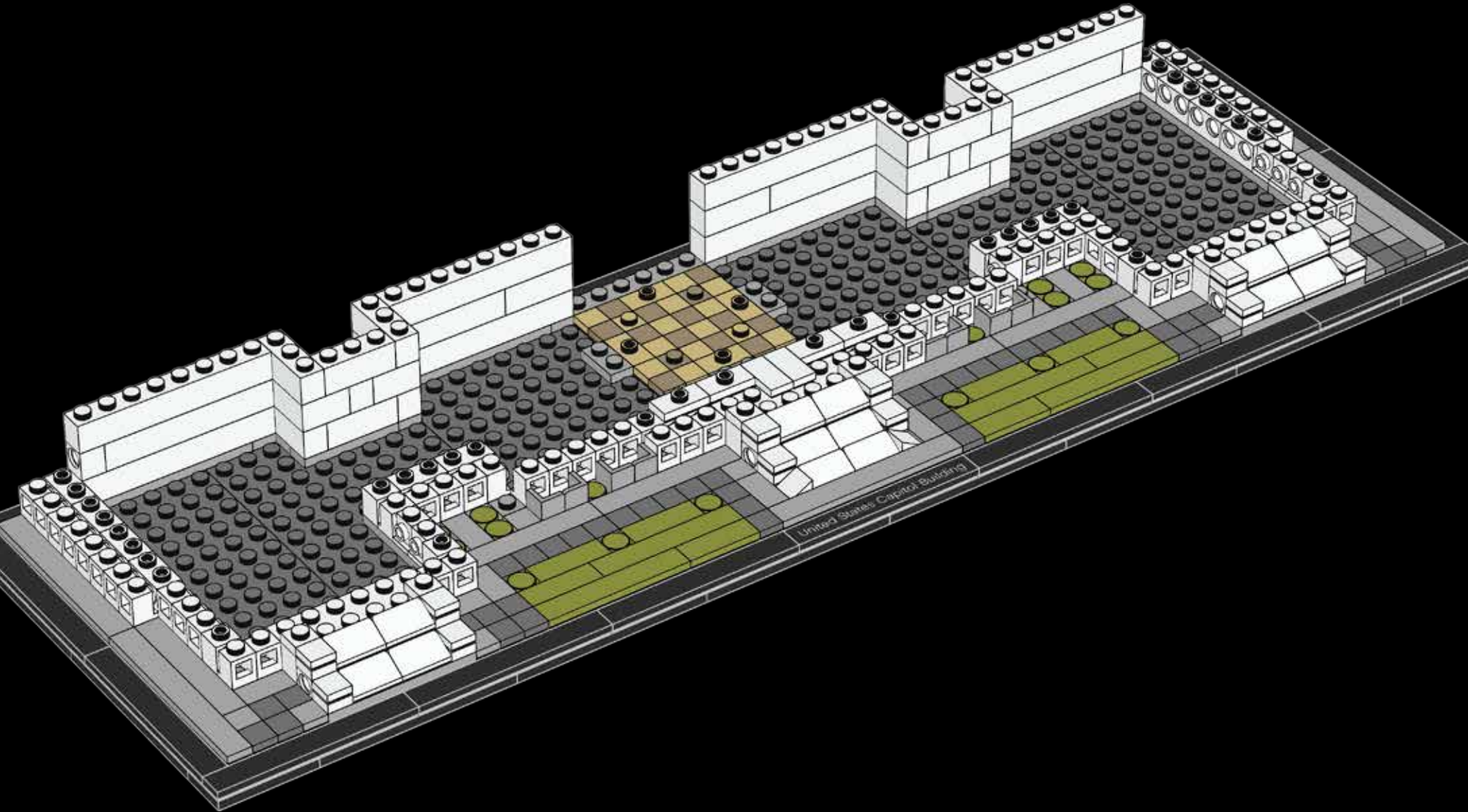



4x

68

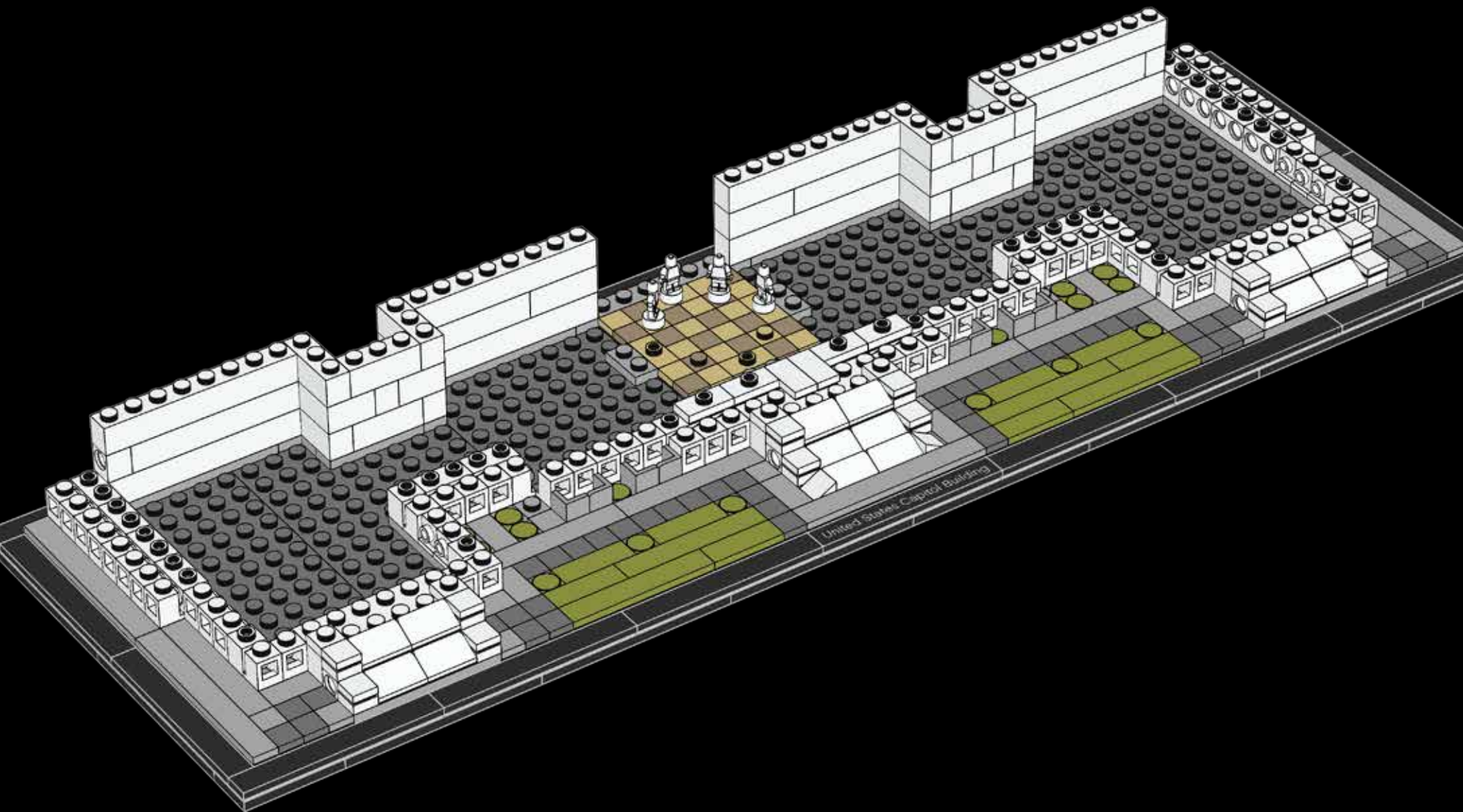



4x

69

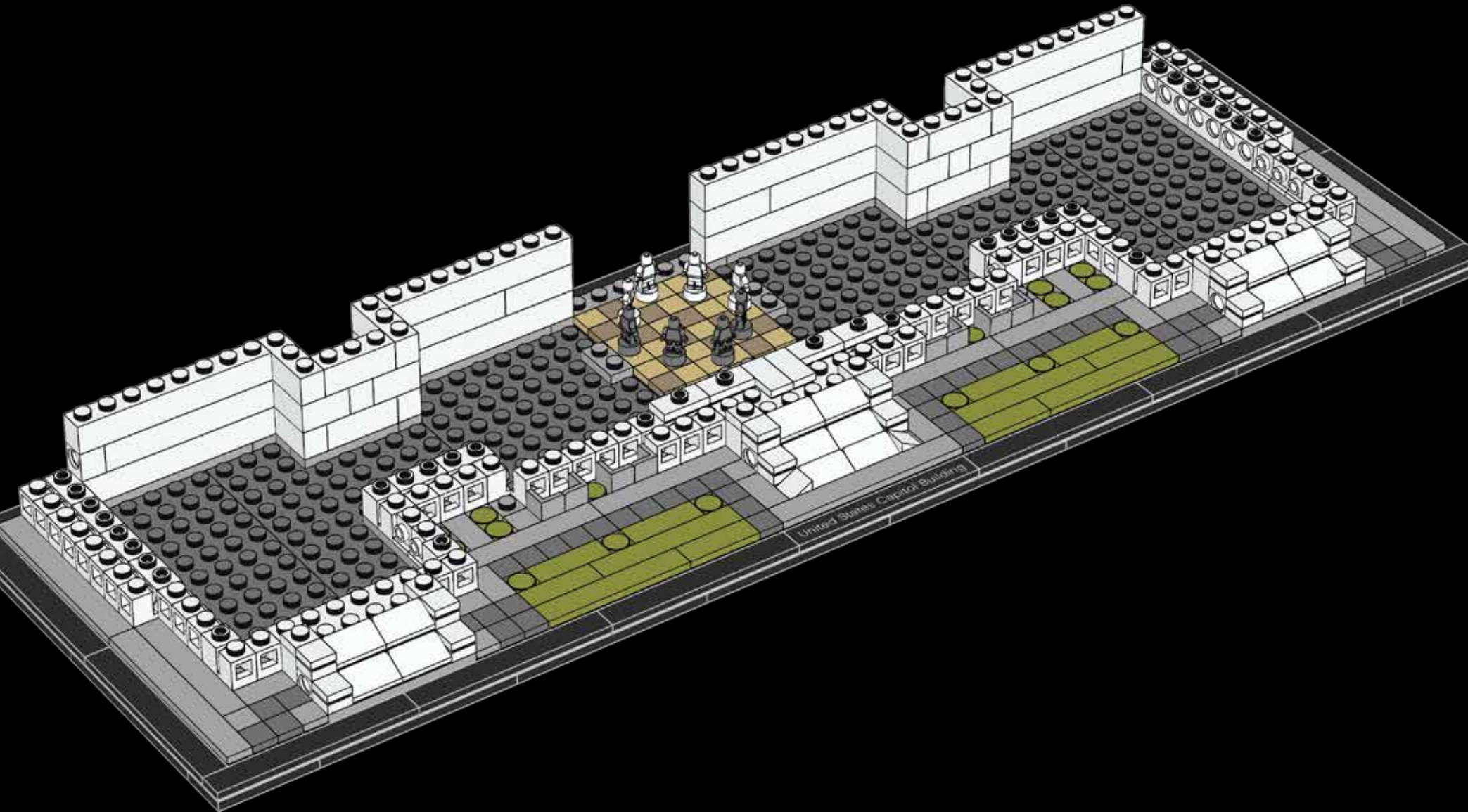





4x

70

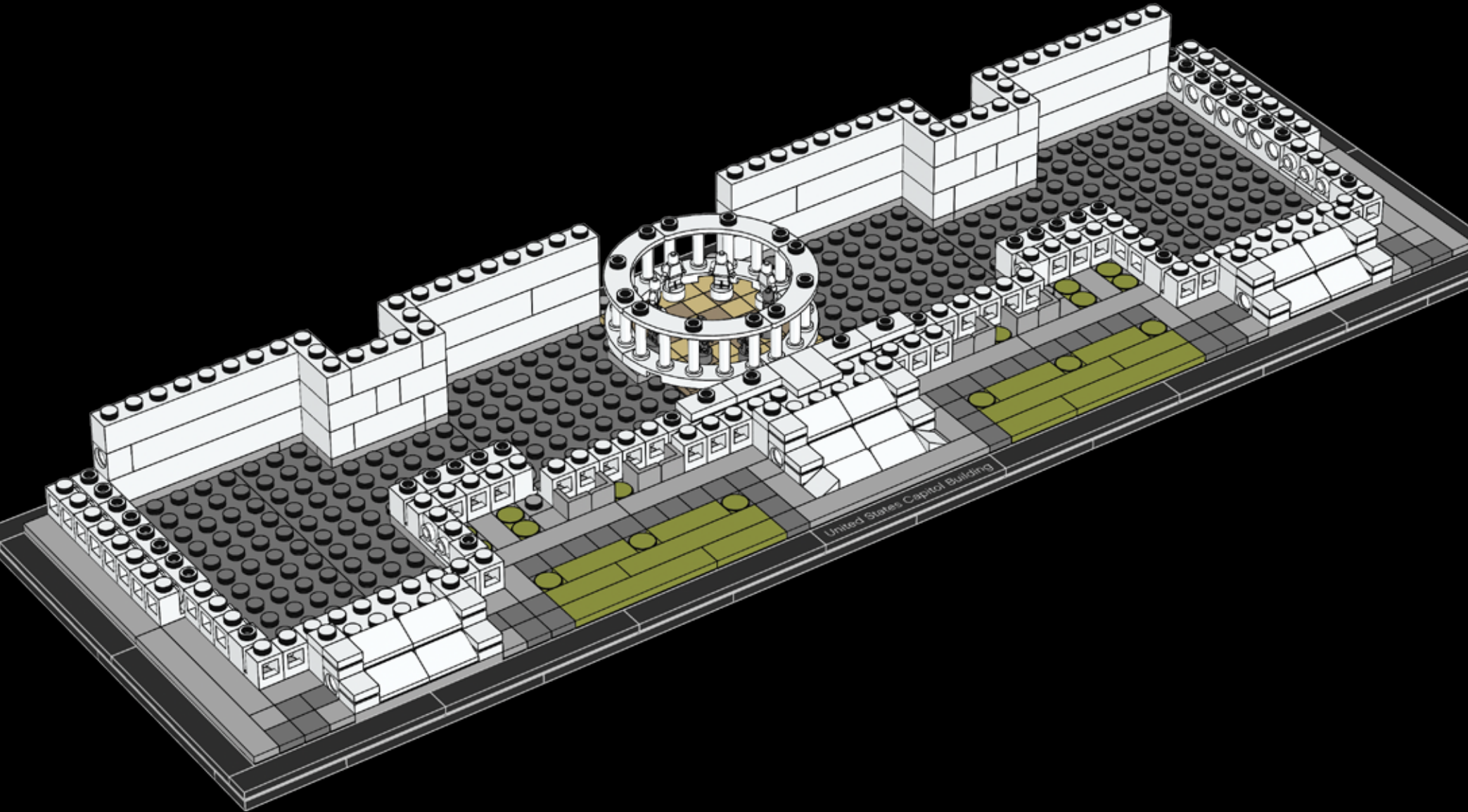



4x

71

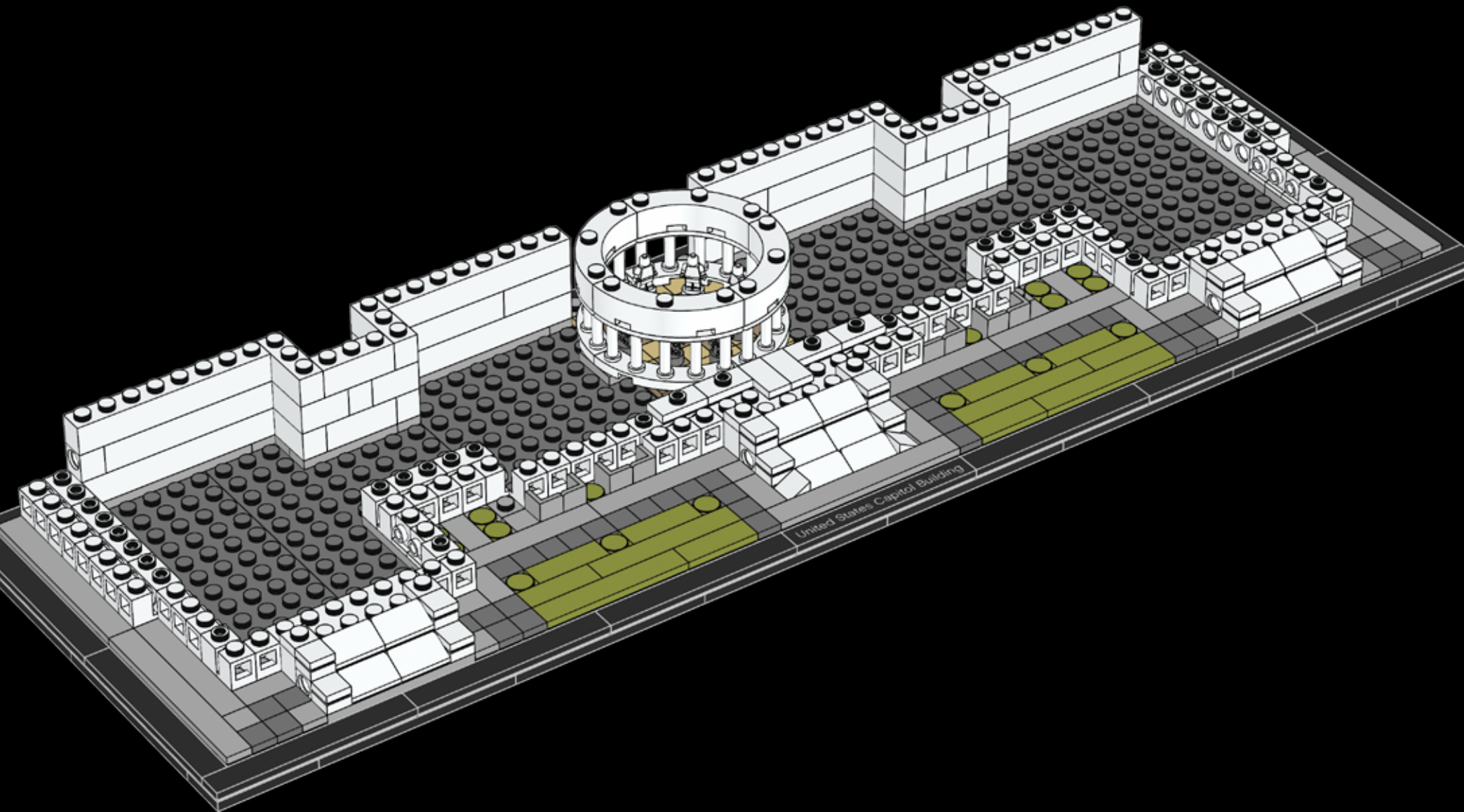



2x



# 72

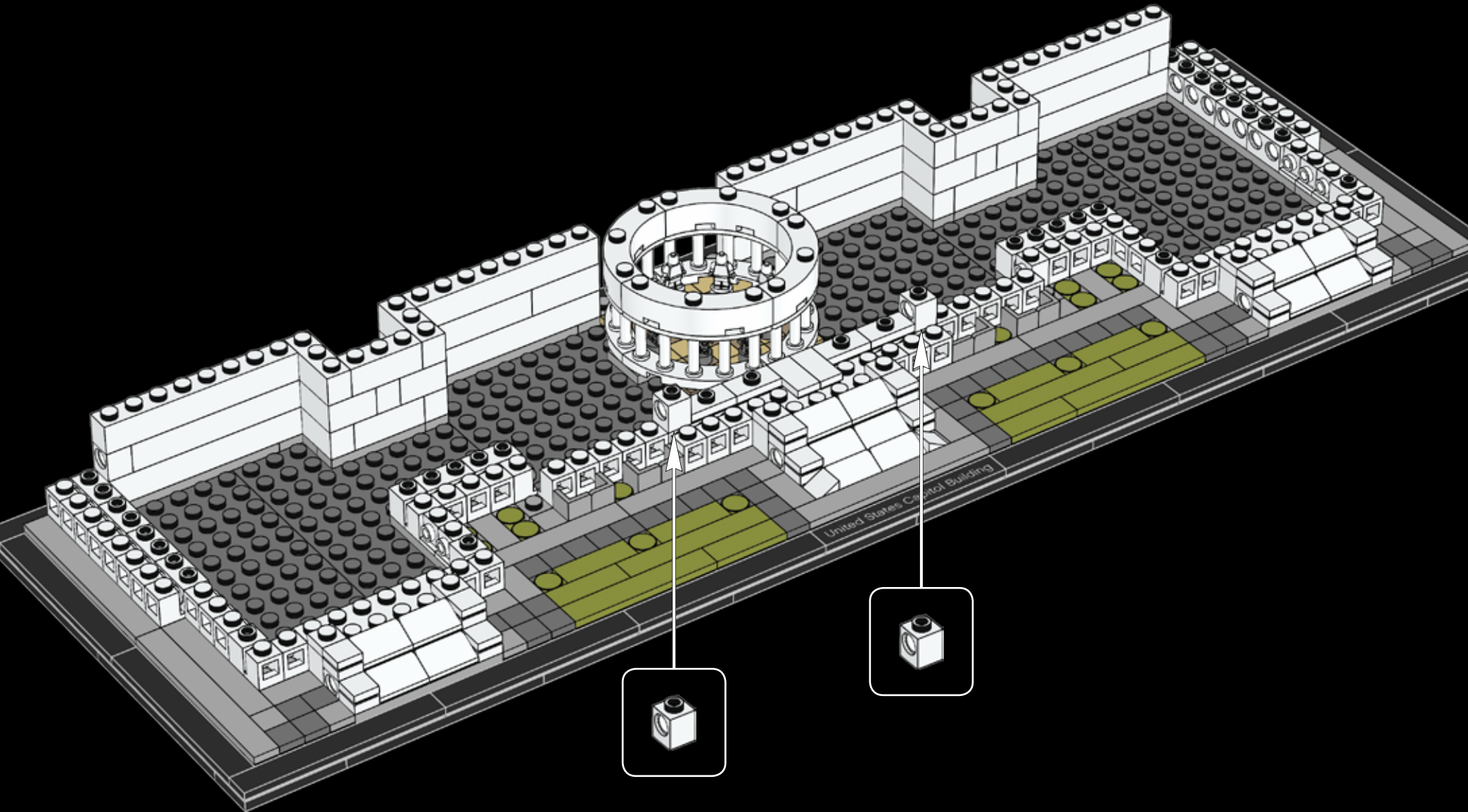



4x



# 73

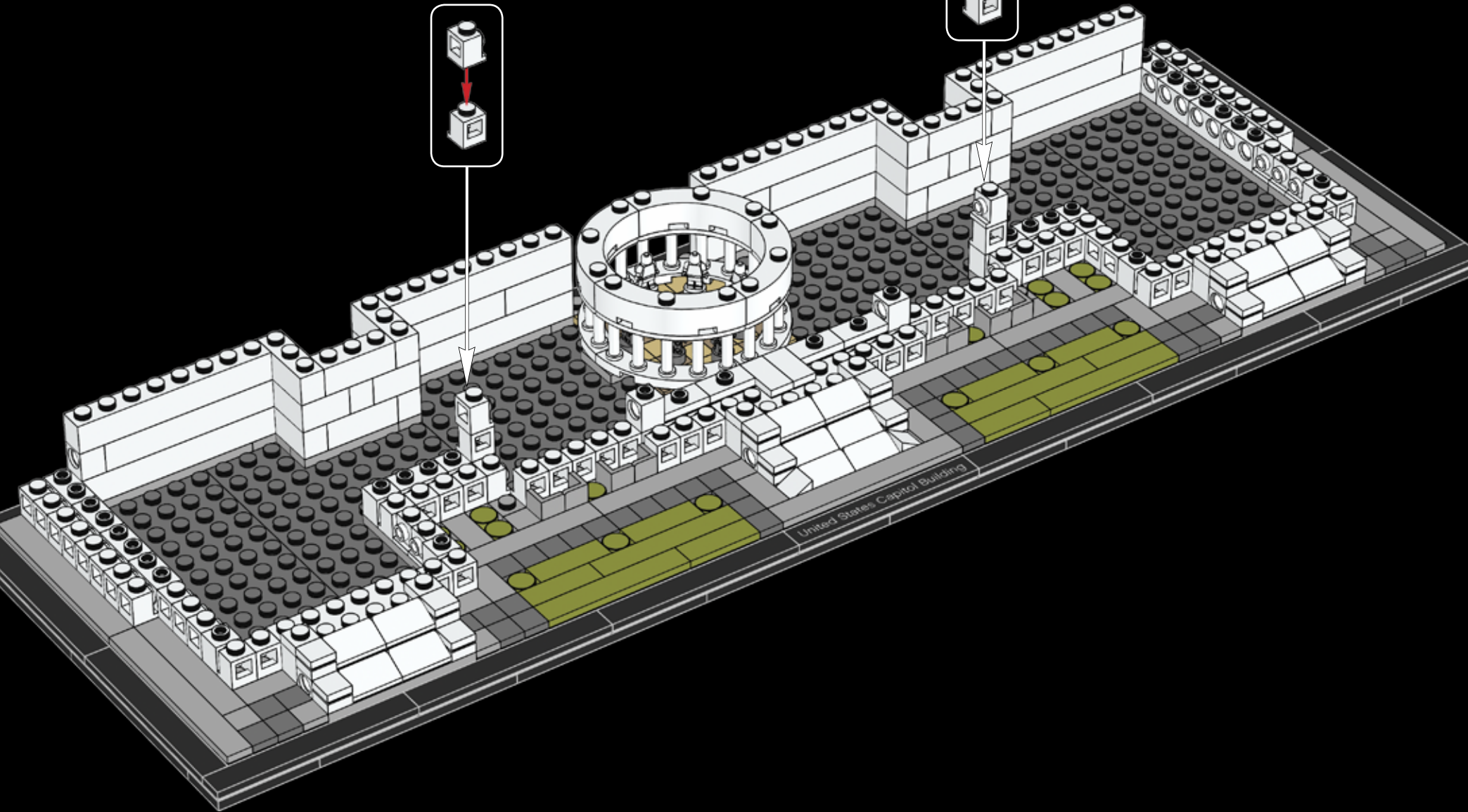
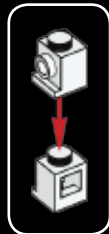

United States Capitol Building



40x



# 74

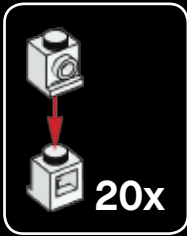

20x

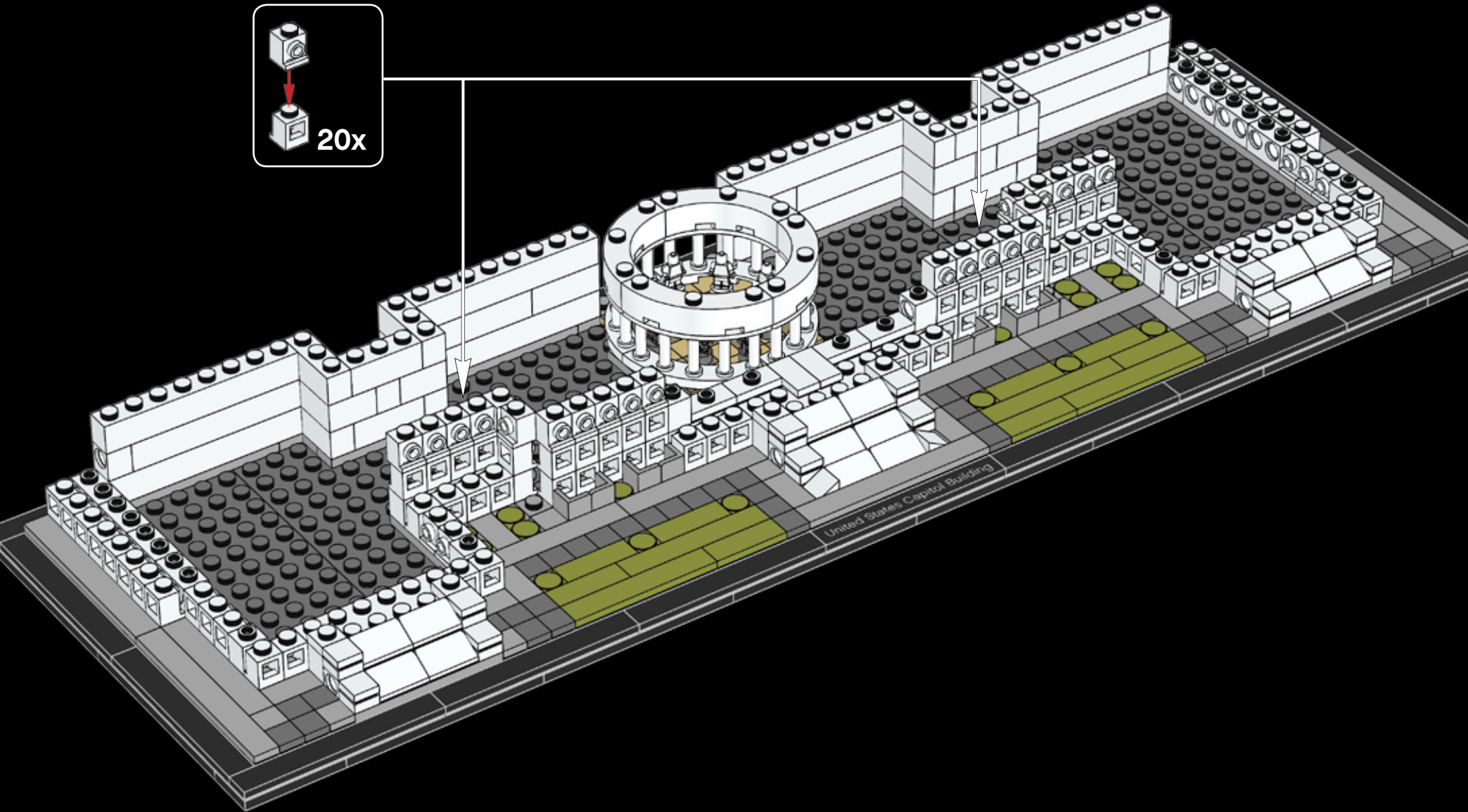



2x

75

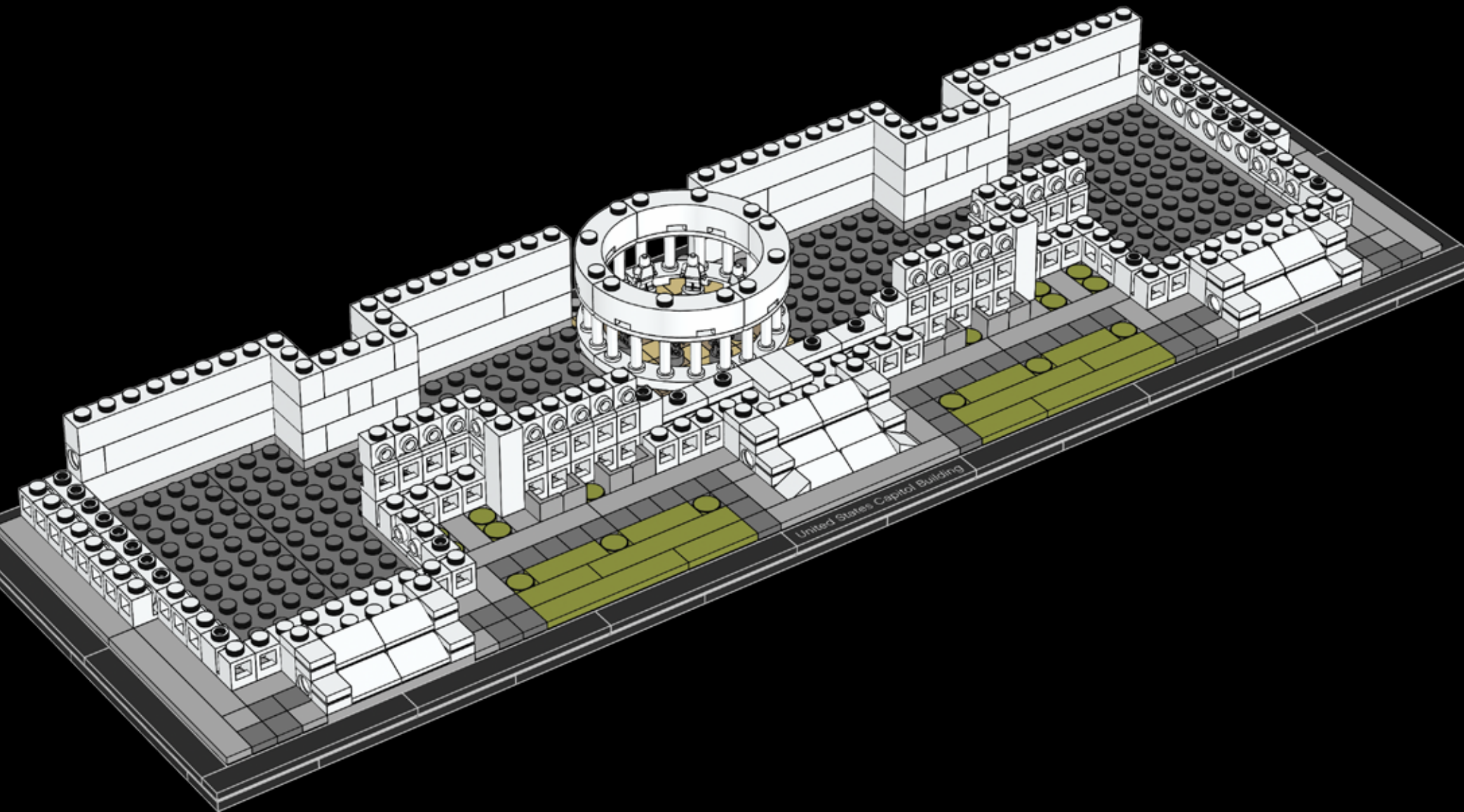



2x

76

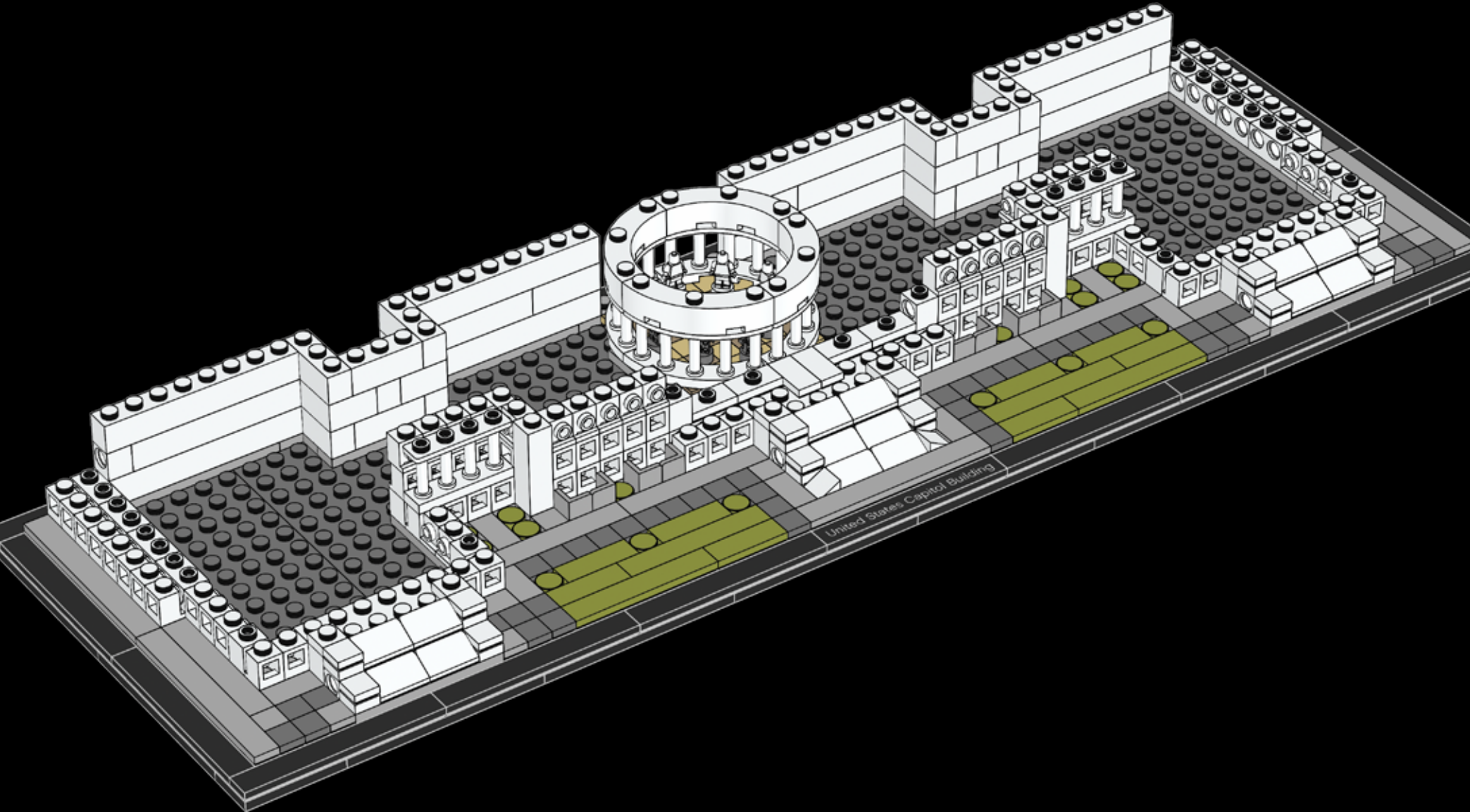



4x

77

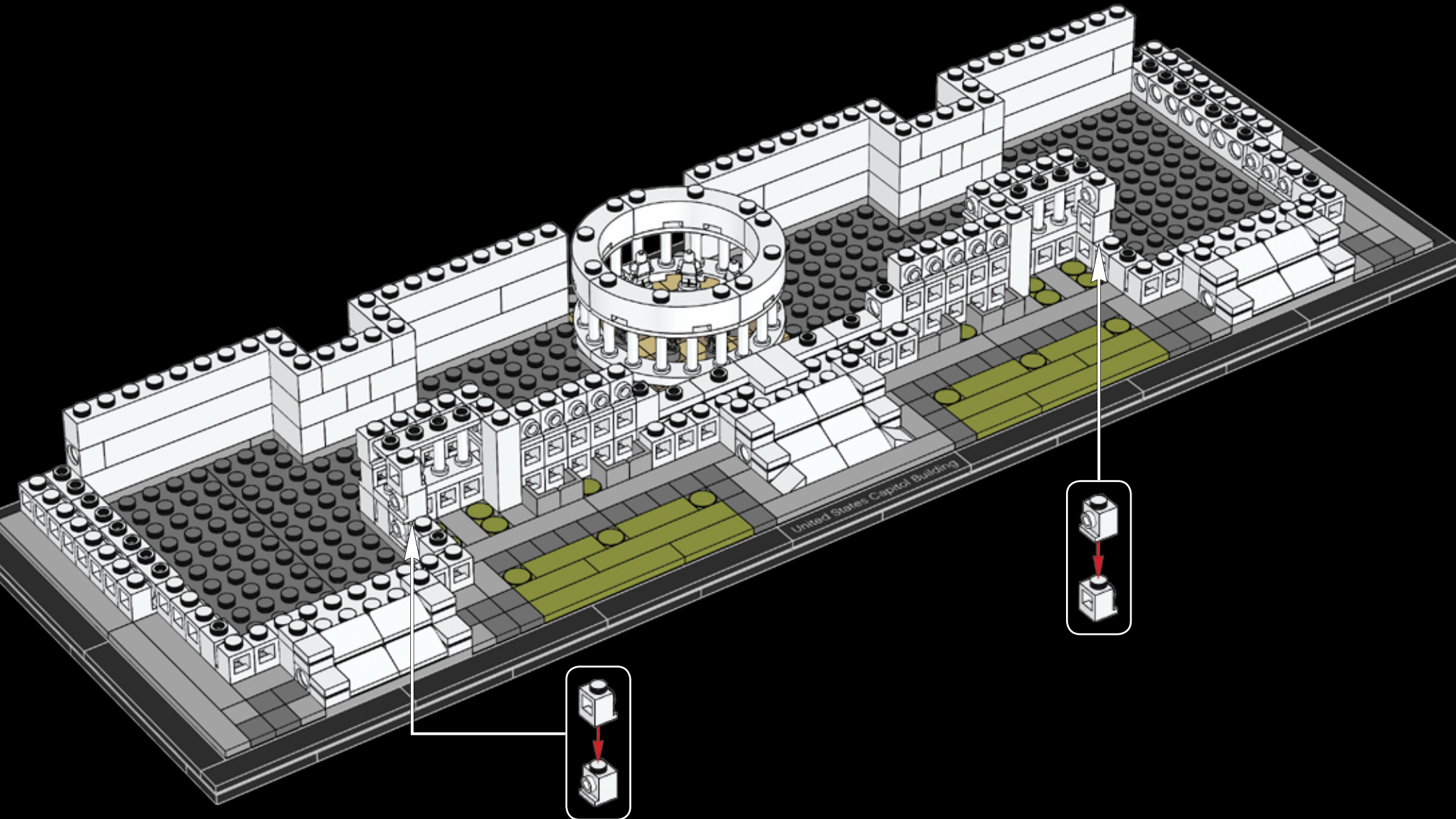





40x

# 78



10x

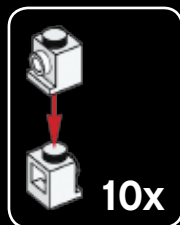

10x

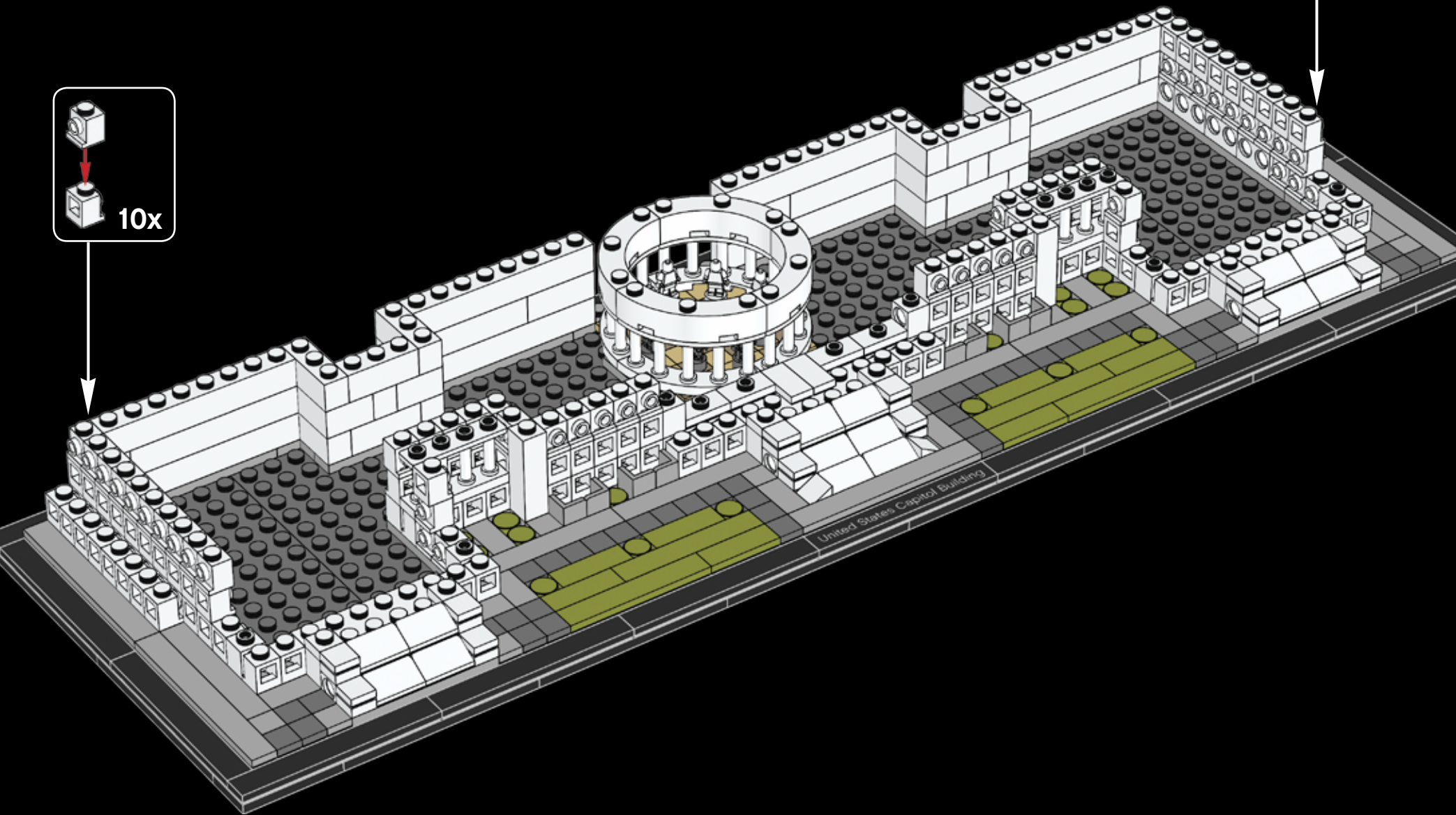



4x

79

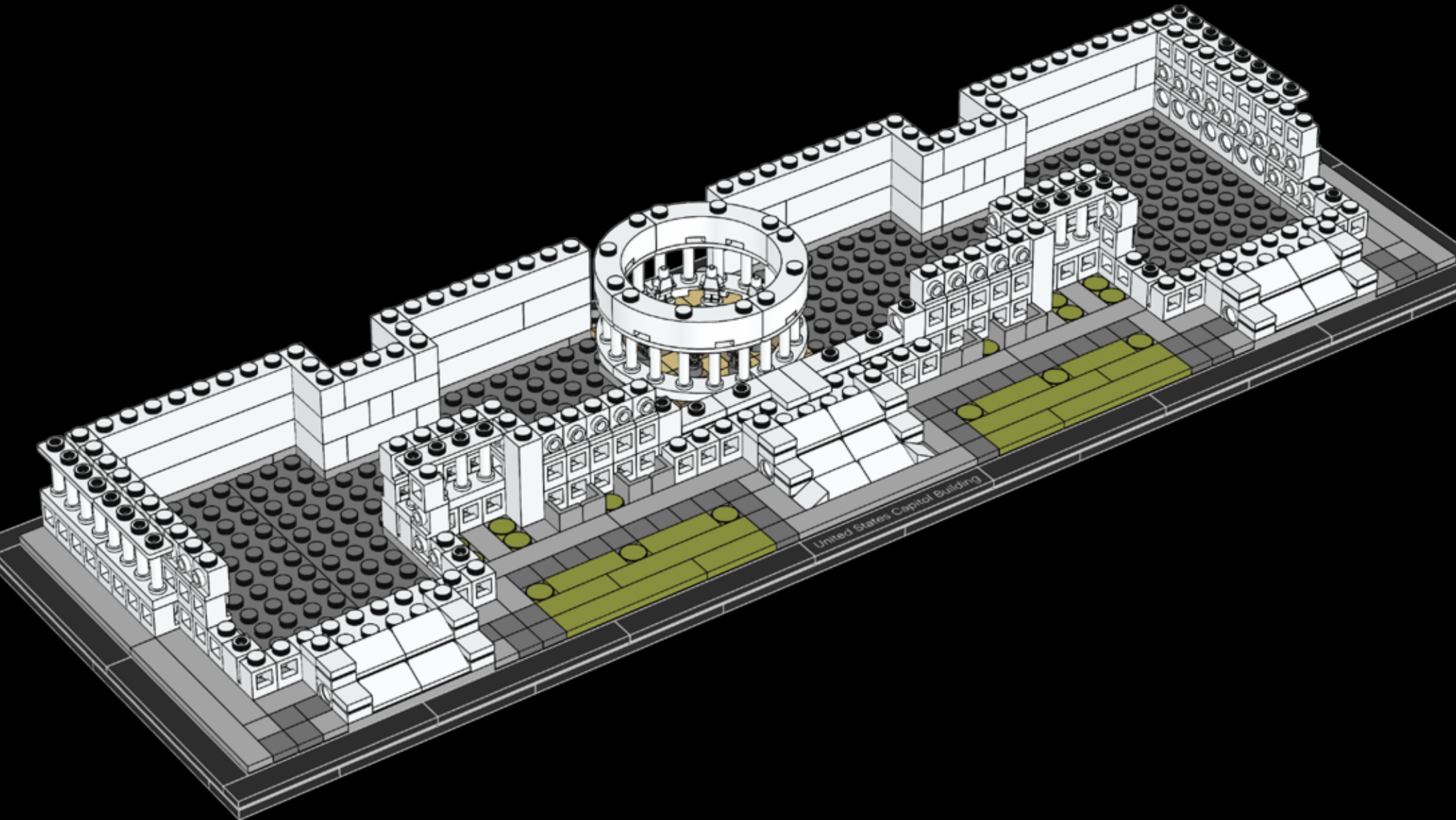



8x



4x



# 80

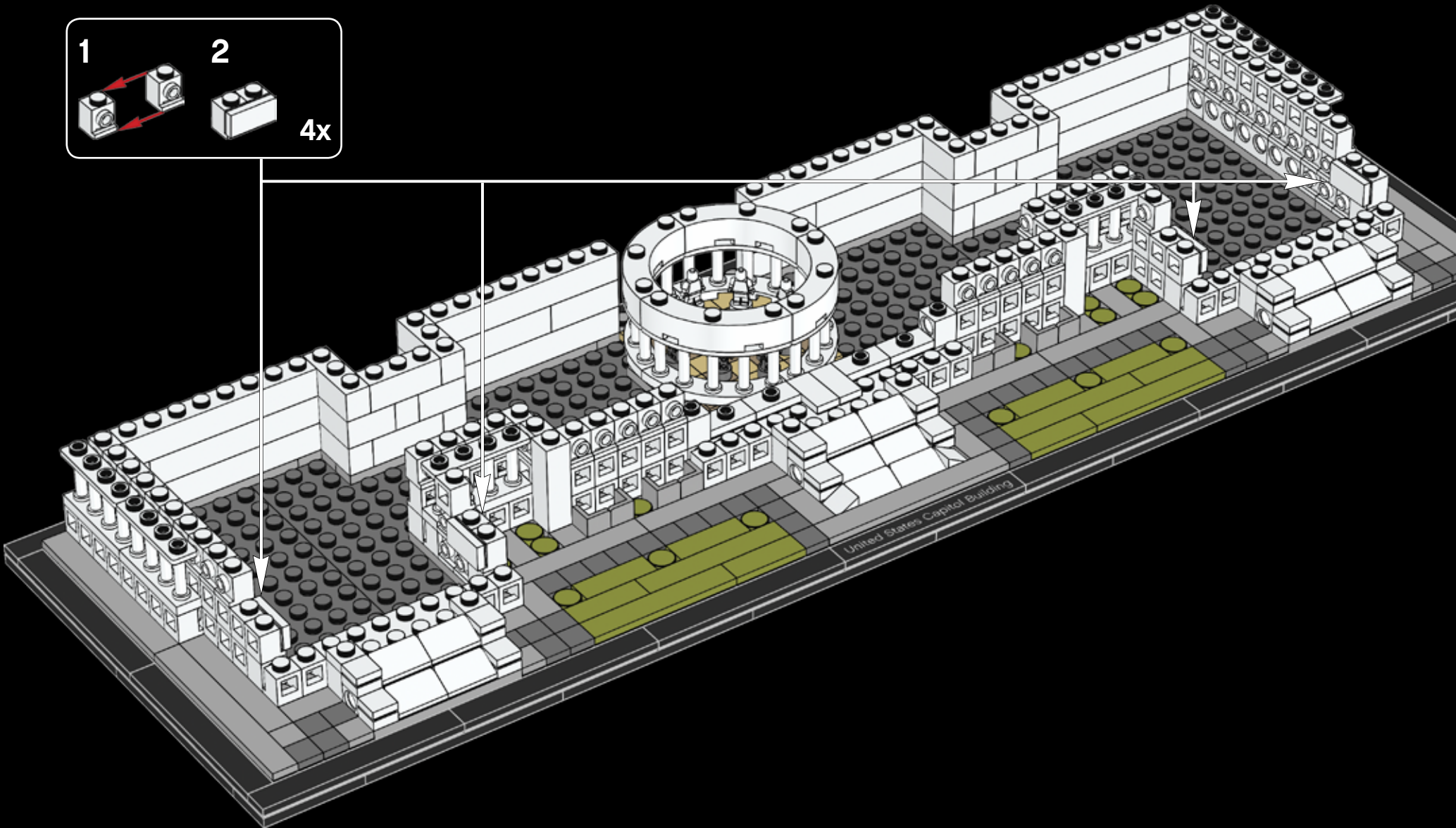
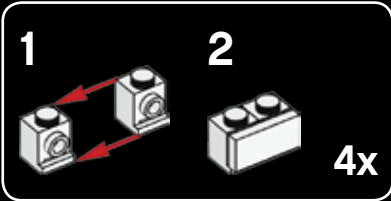



8x



4x



# 81

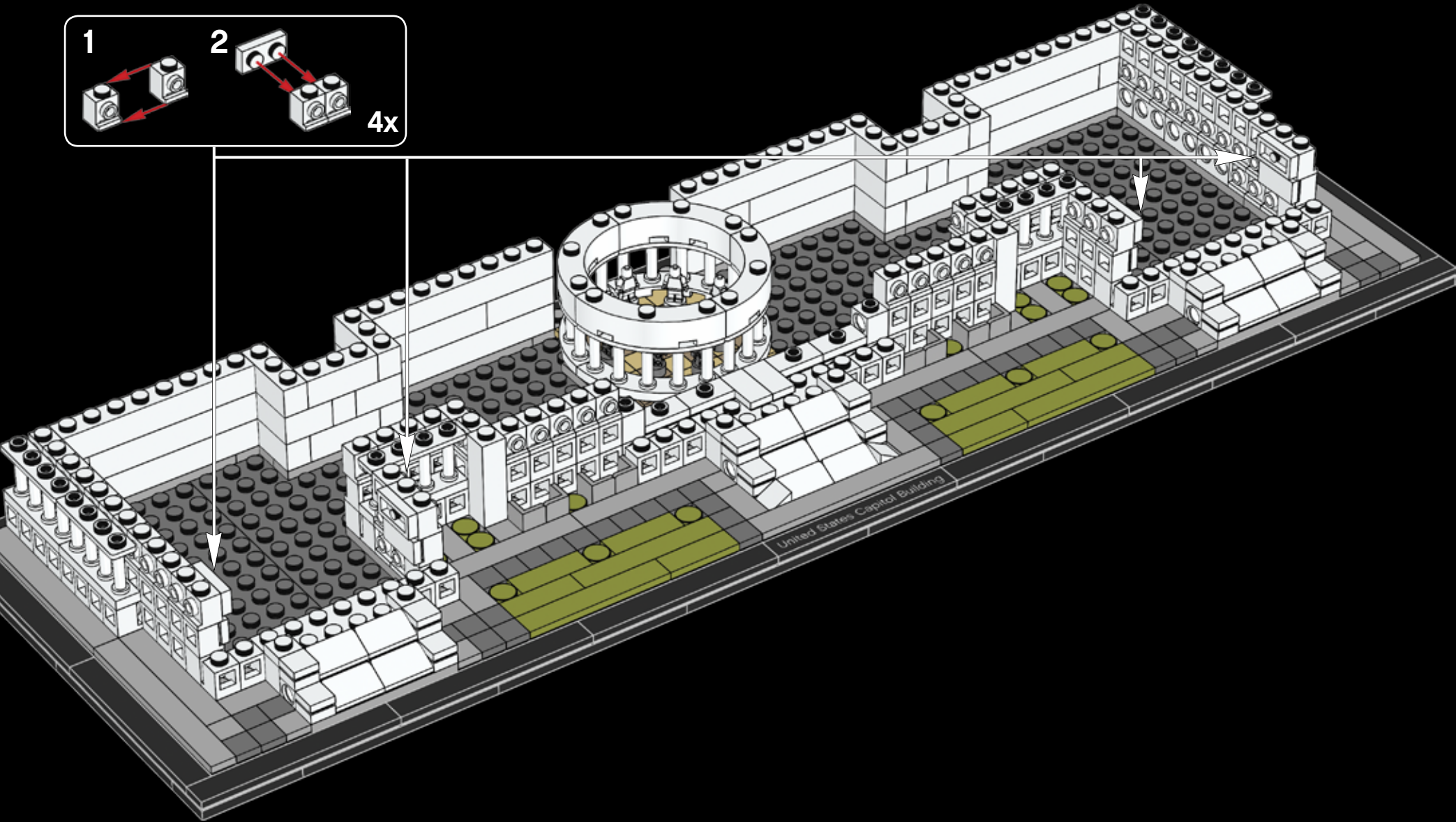
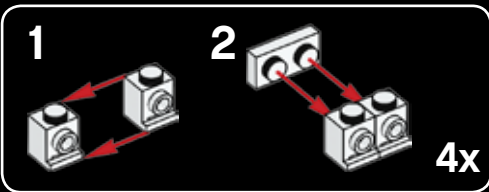



2x



1x

82



1x

83



1x

84



1x

85





86



87

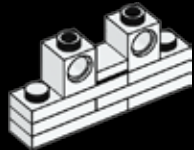

88

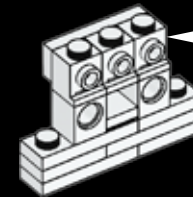
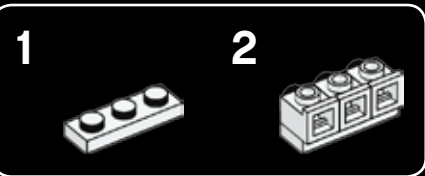

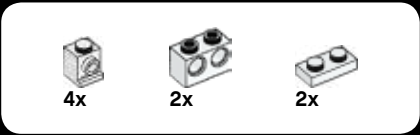

89

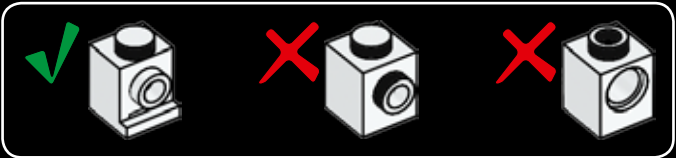
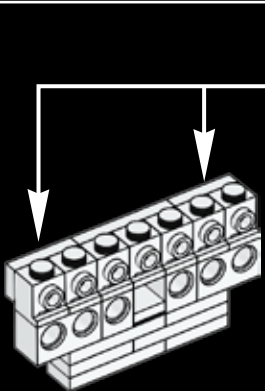
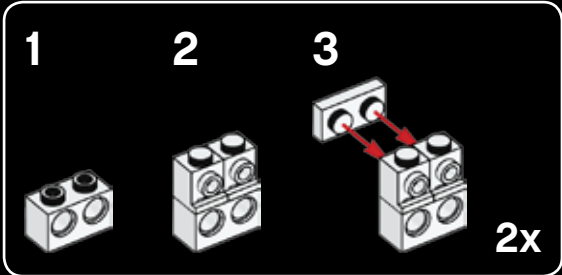

90

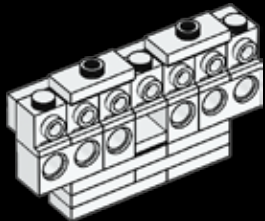

2x

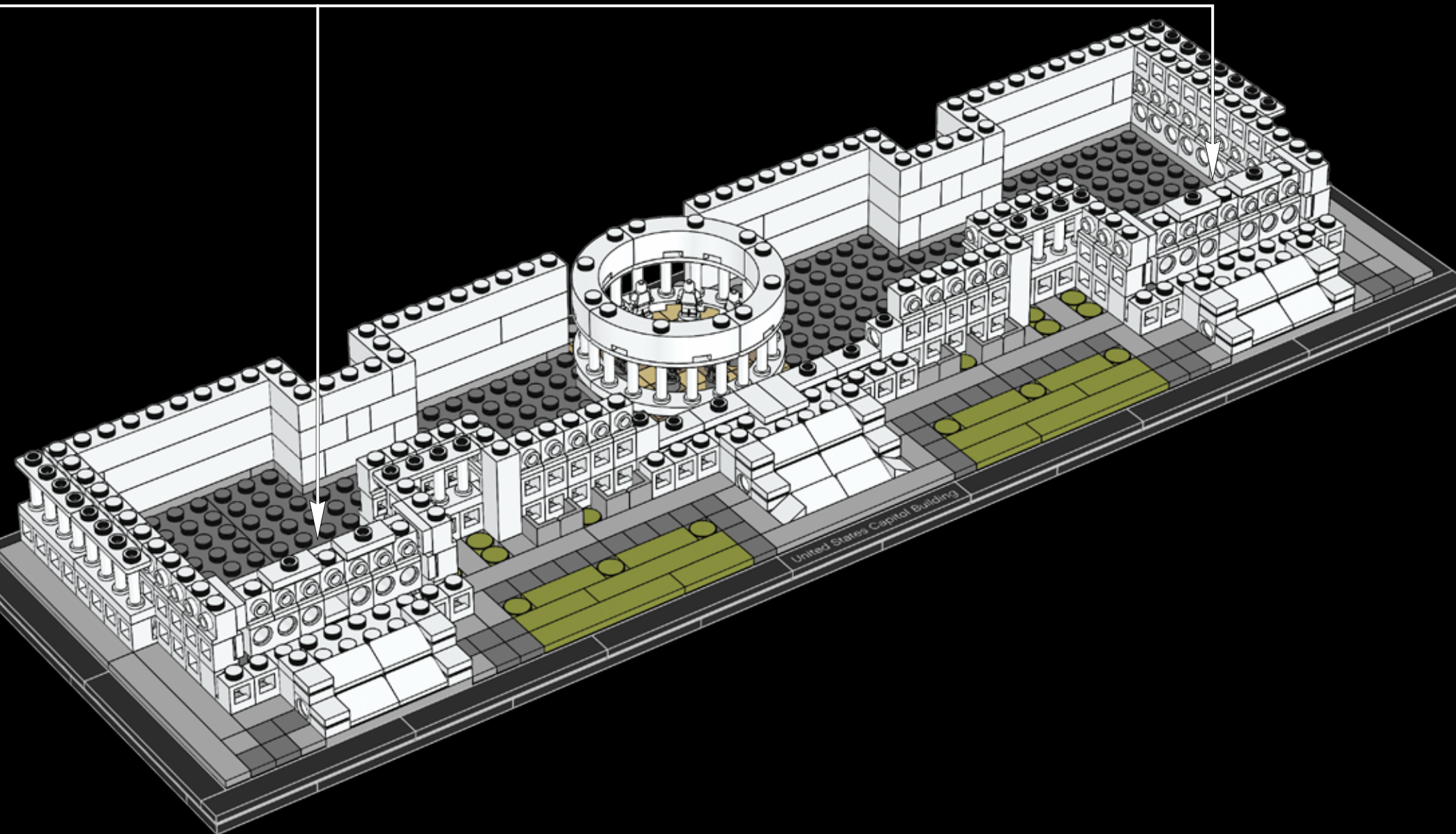





2x



92



2x

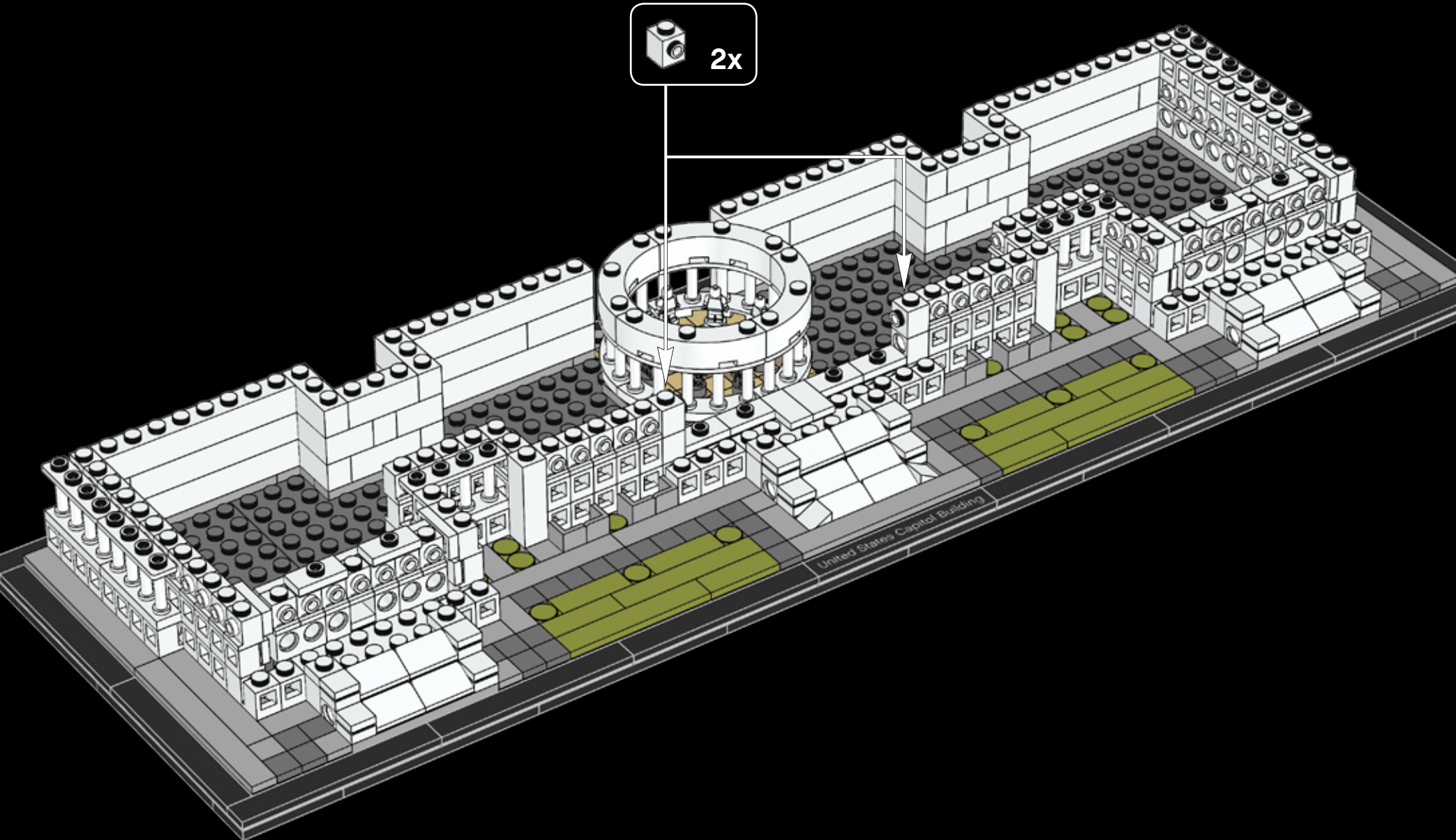



2x

93



2x

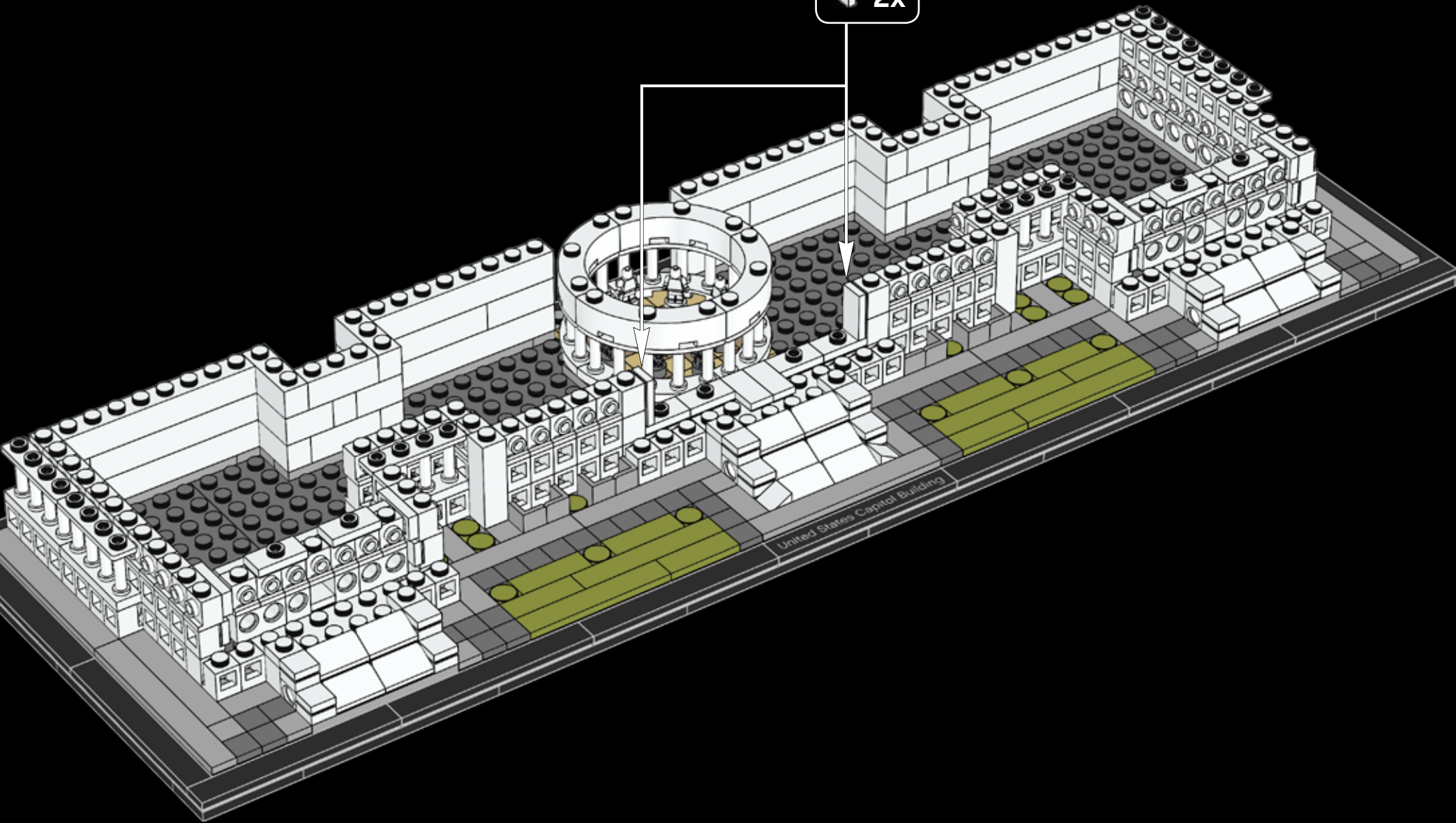



1x

94



1x

95



1x

96

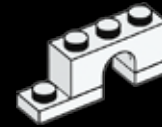

1x

97





1x

98

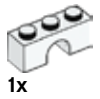
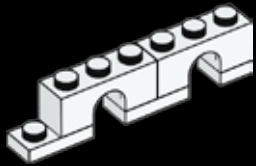

1x

99

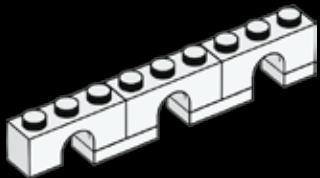

1x

100

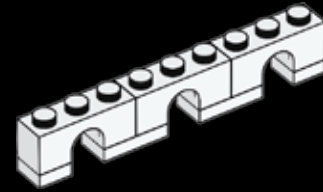

1x



4x

101

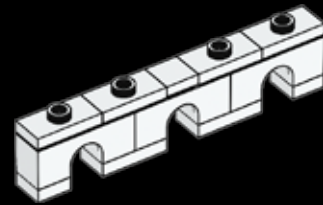

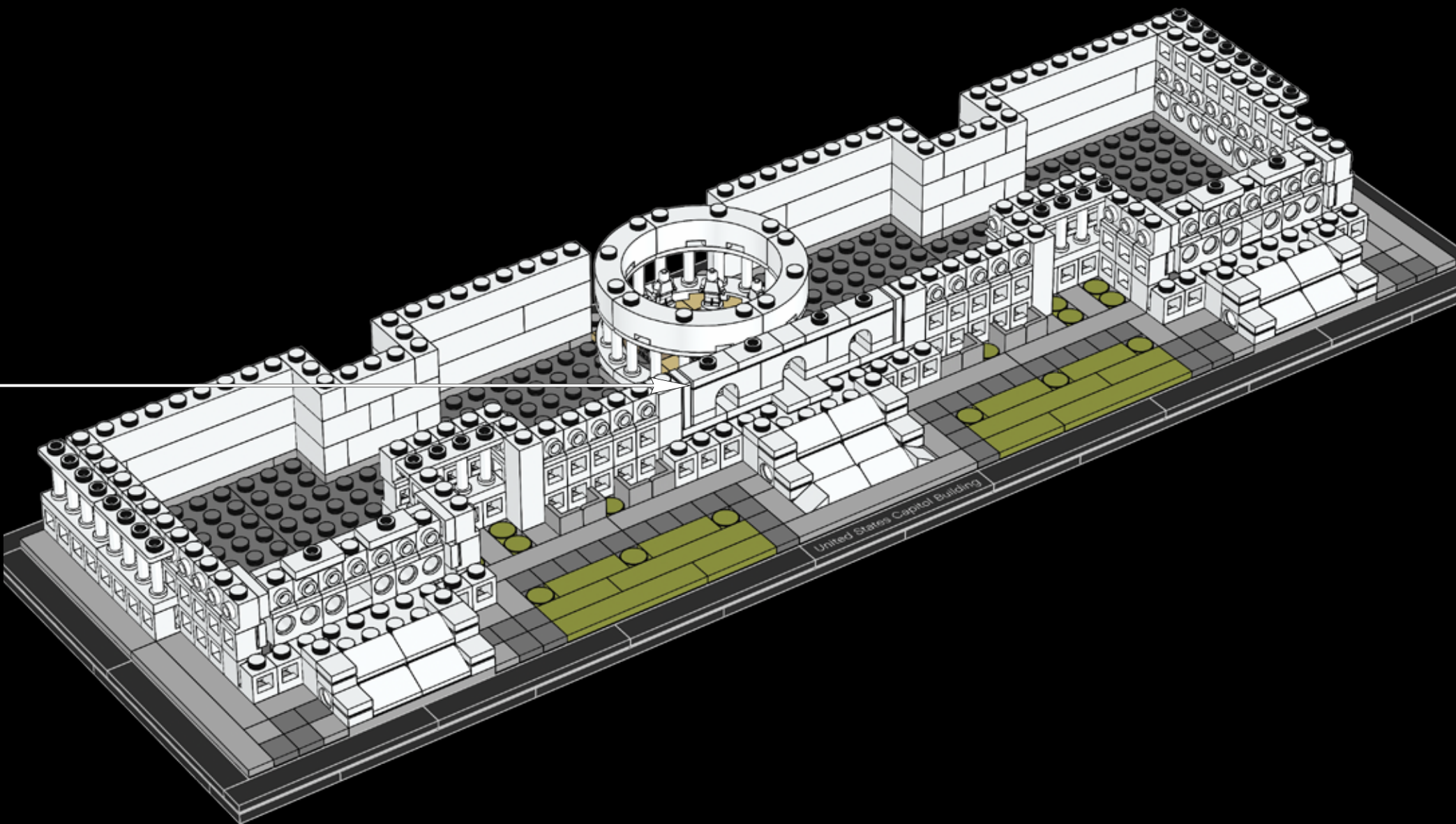



6x

# 103

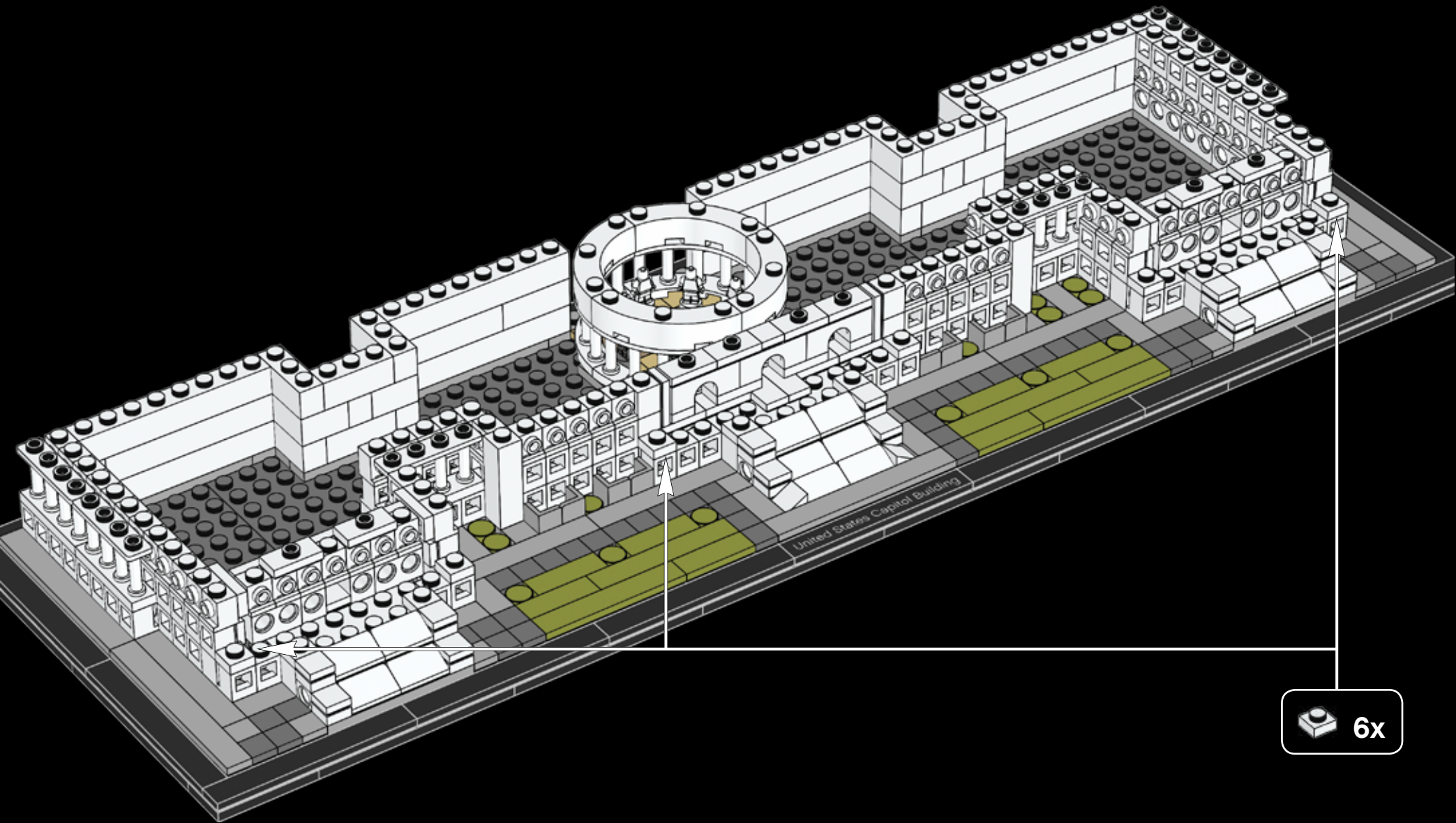

6x



6x

104

The U.S. Capitol Building is divided into five levels. The second floor holds both the Chambers of the House of Representatives and the Senate.

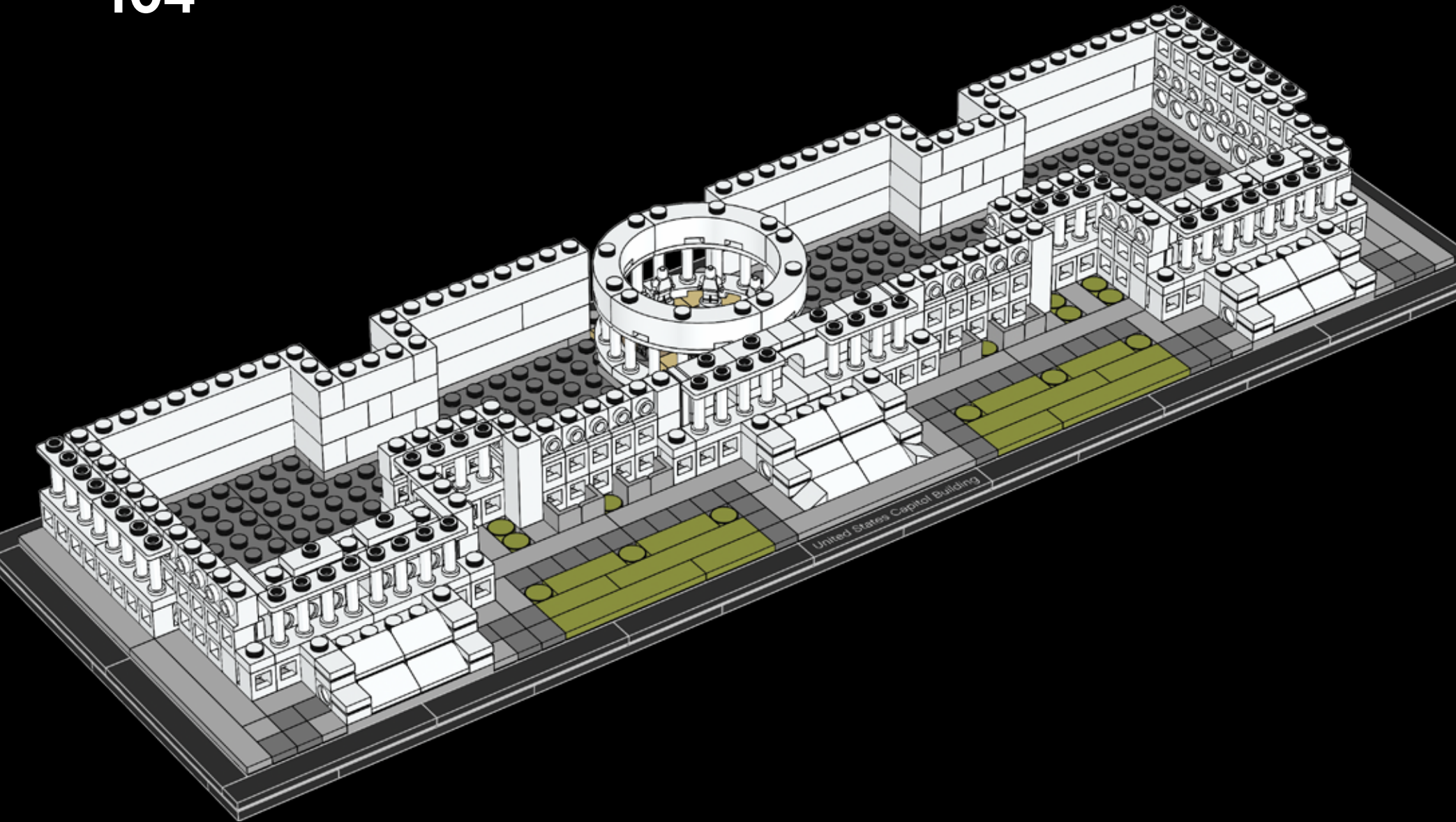



3x

105

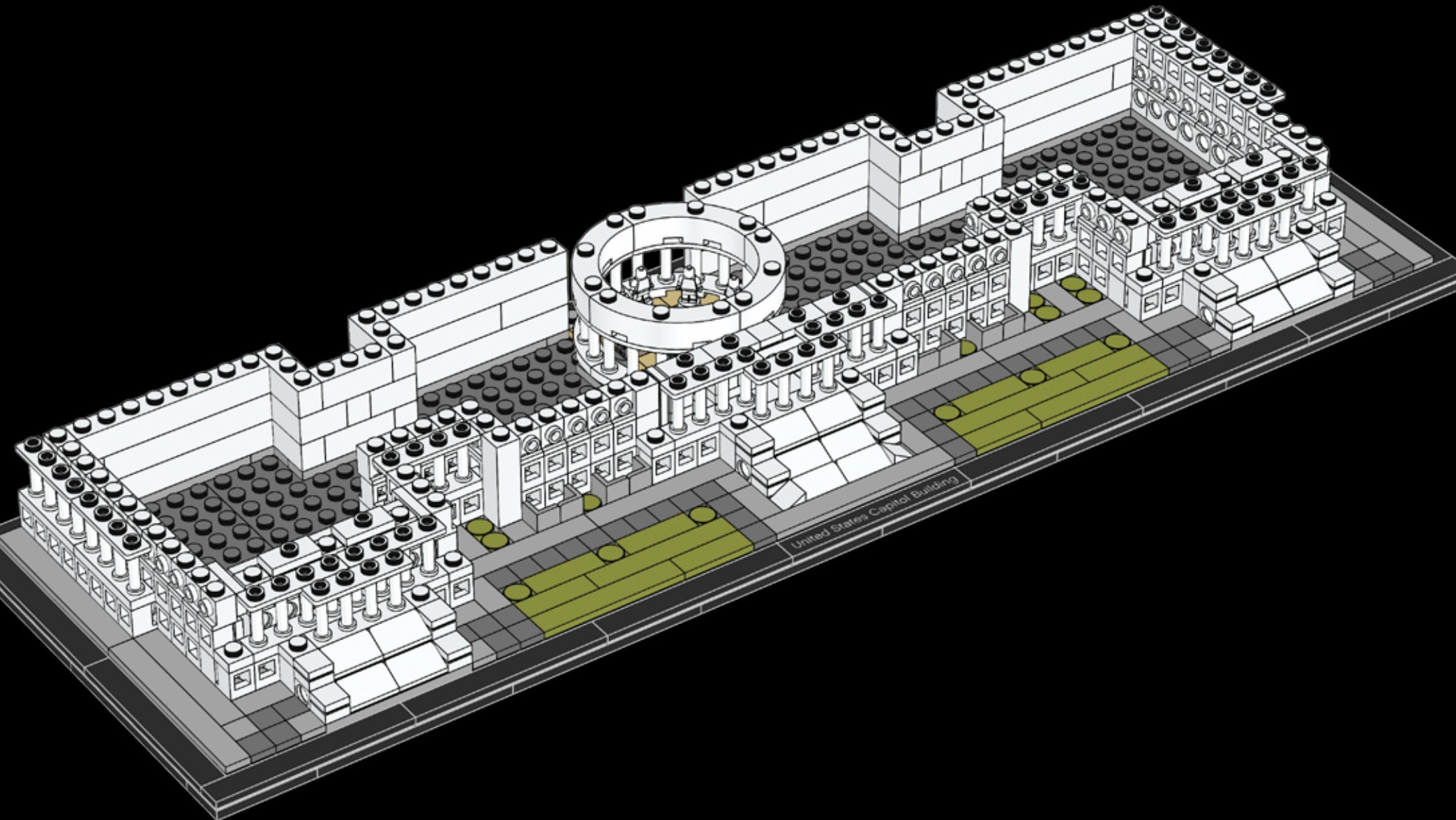





12x

# 106

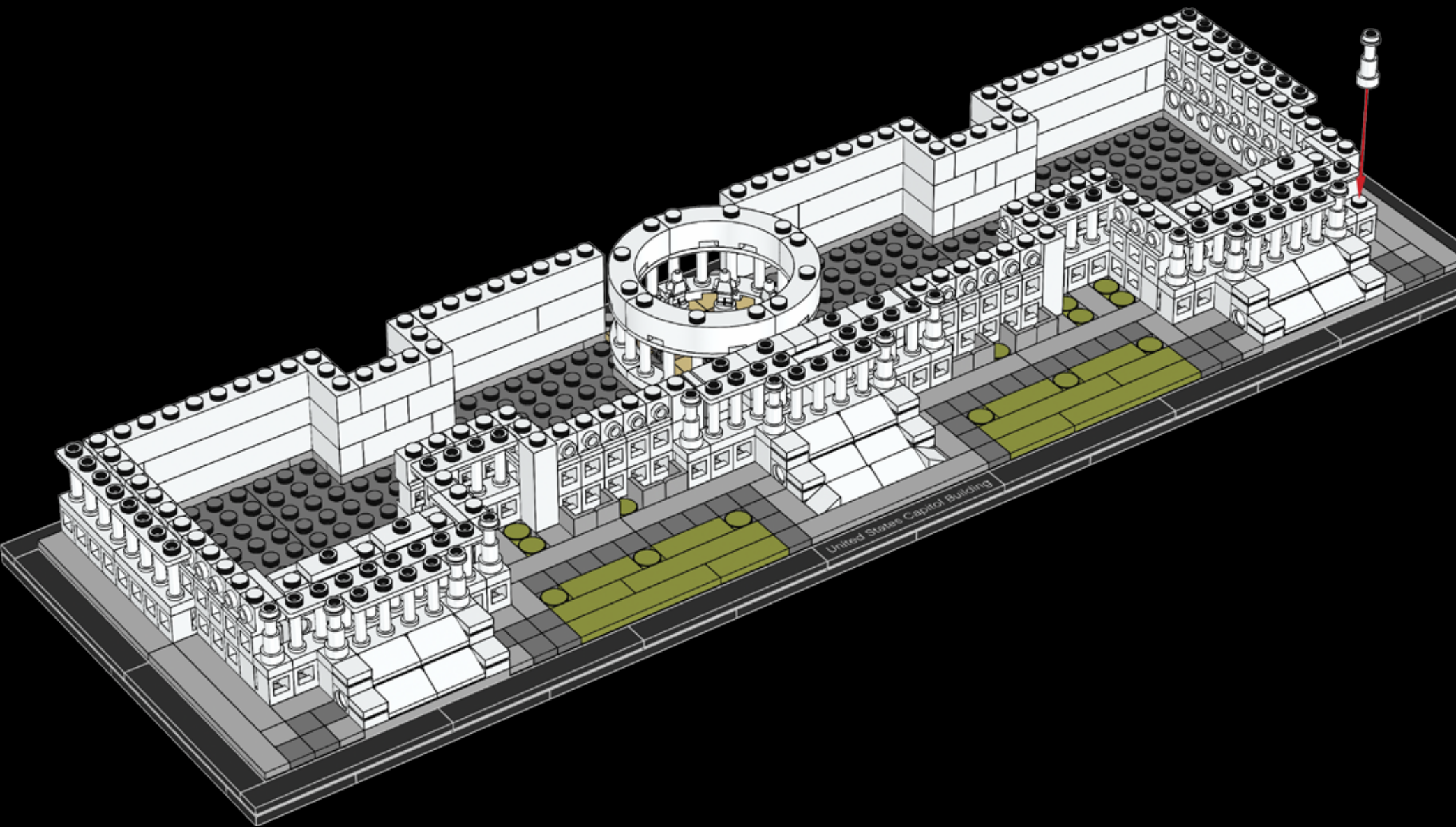



2x



2x

# 107

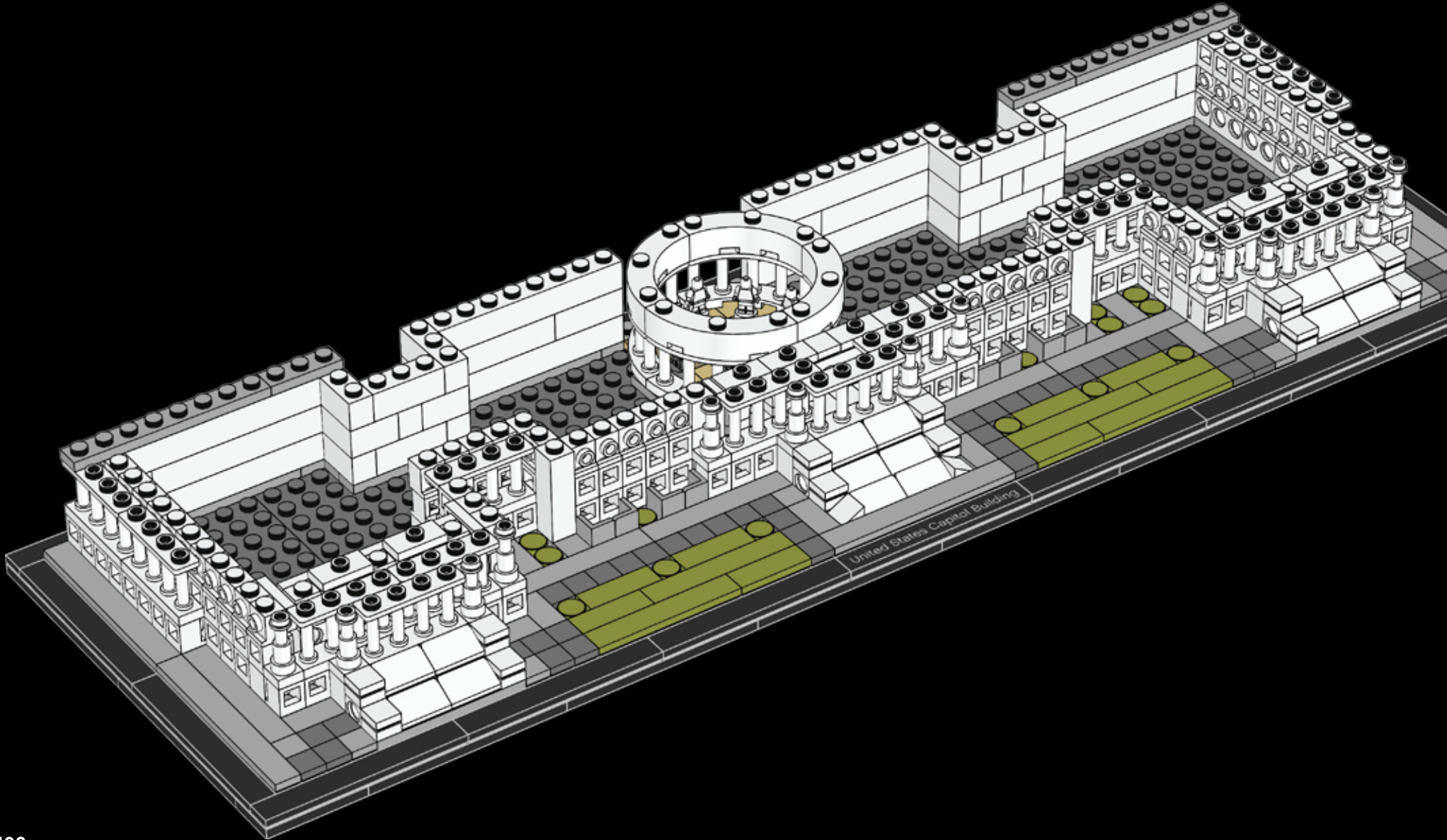

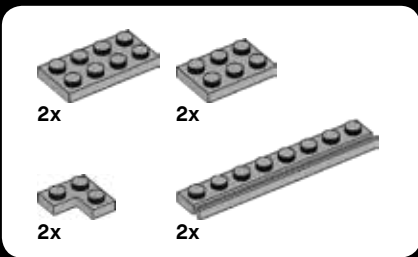

108

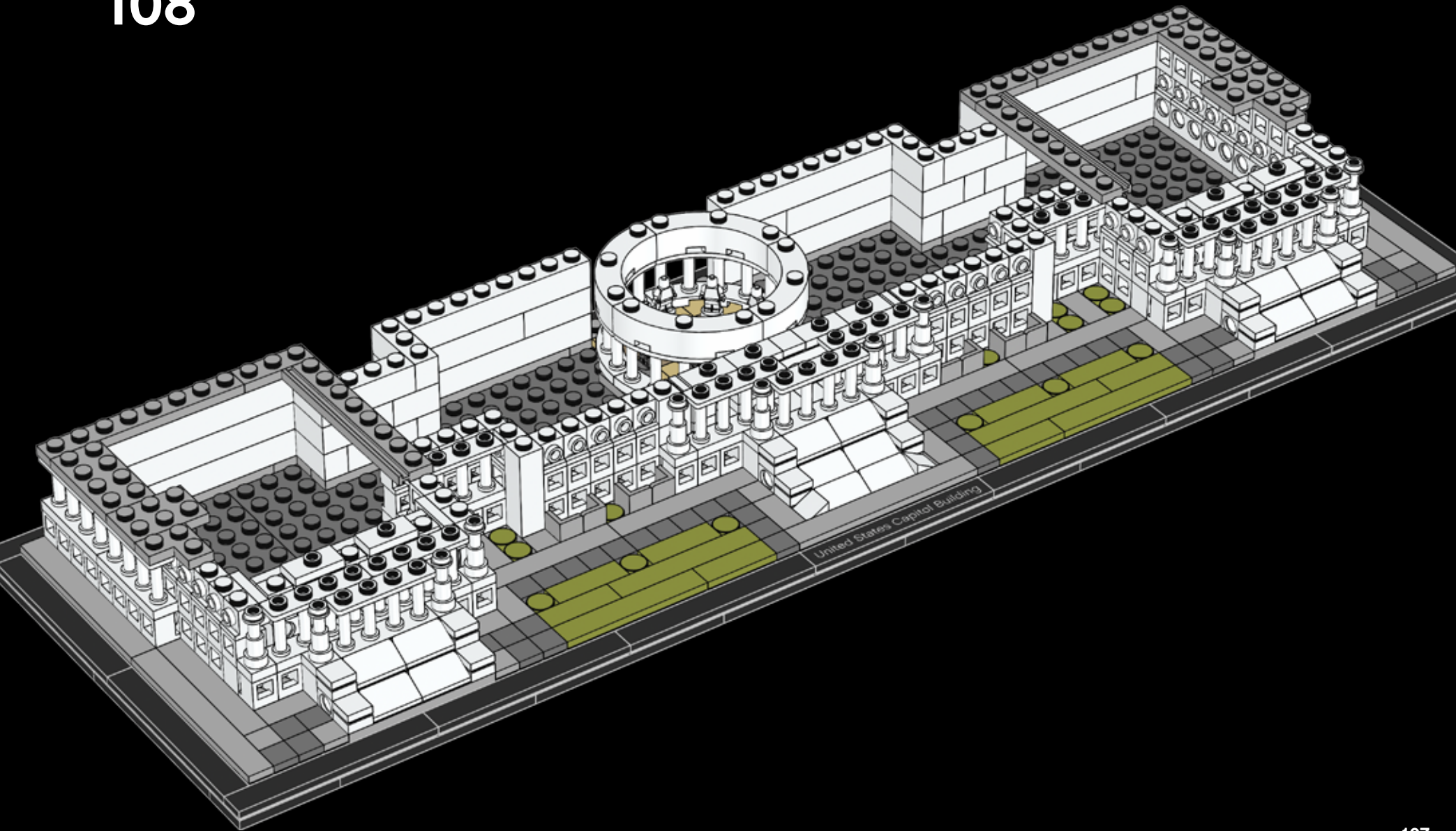

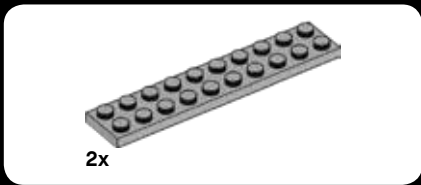

109

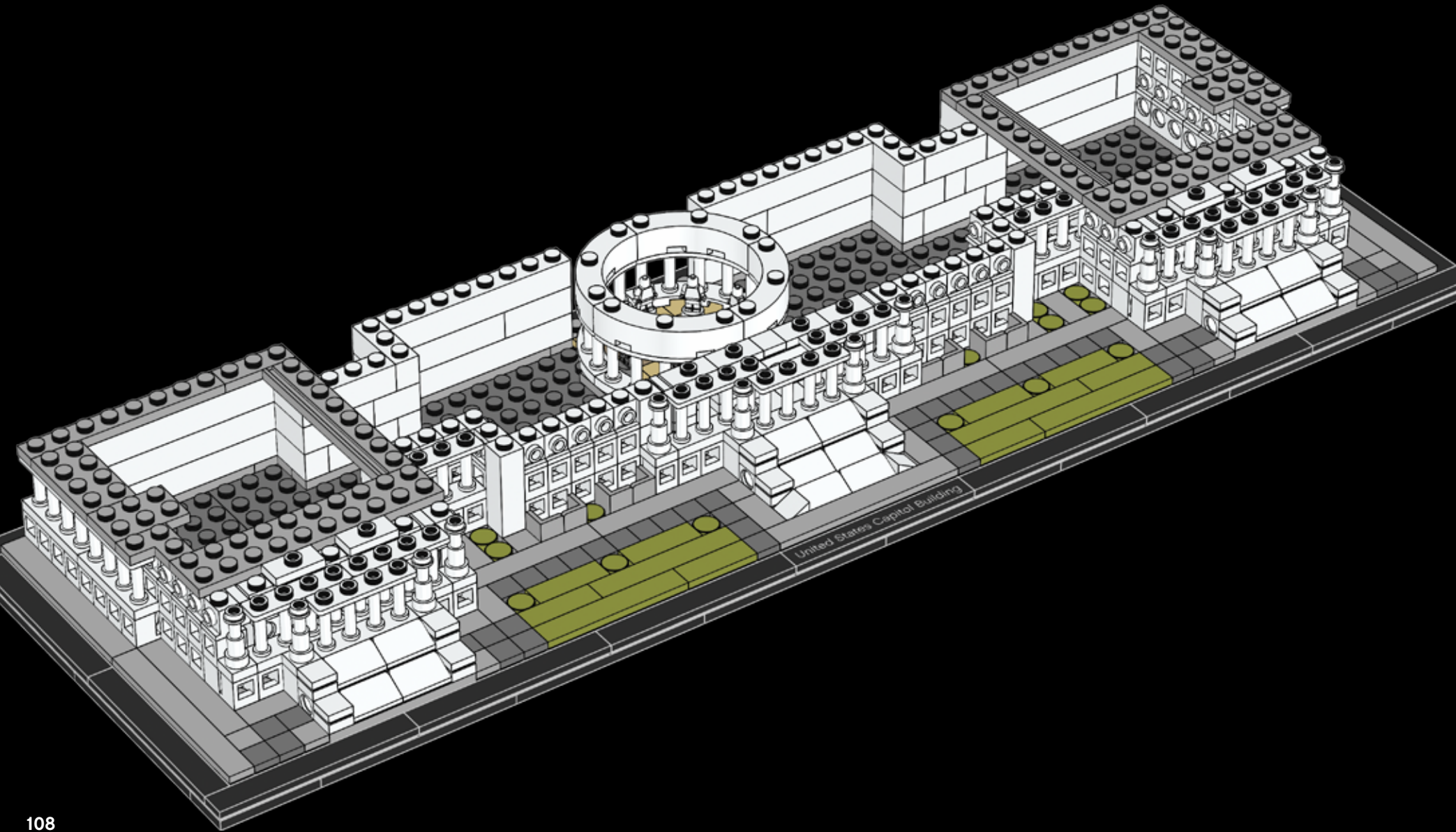

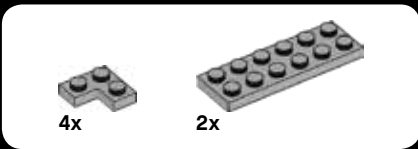

110

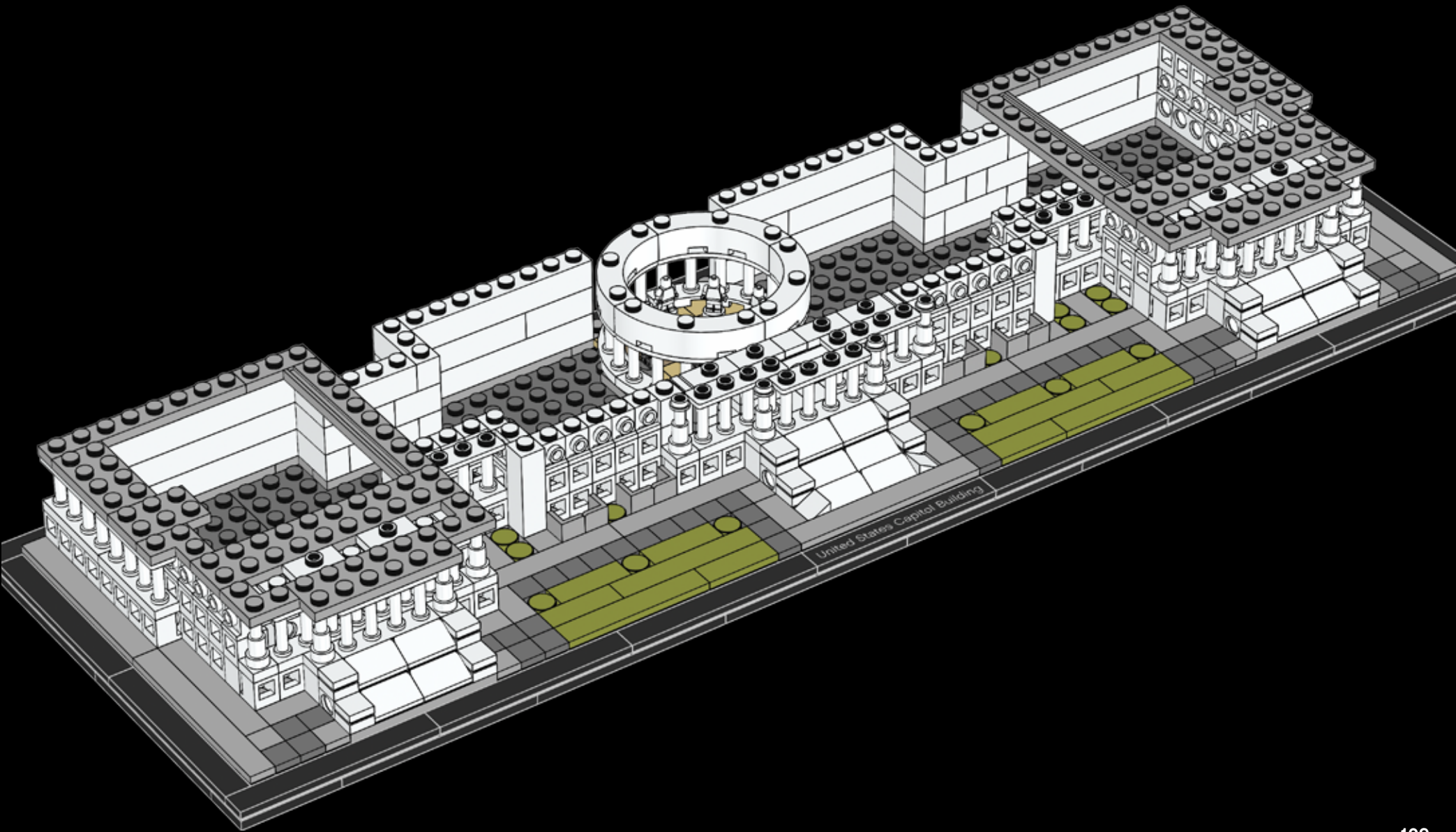

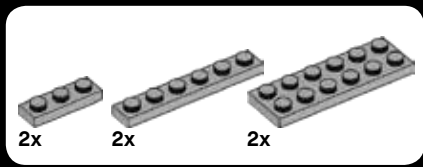

111

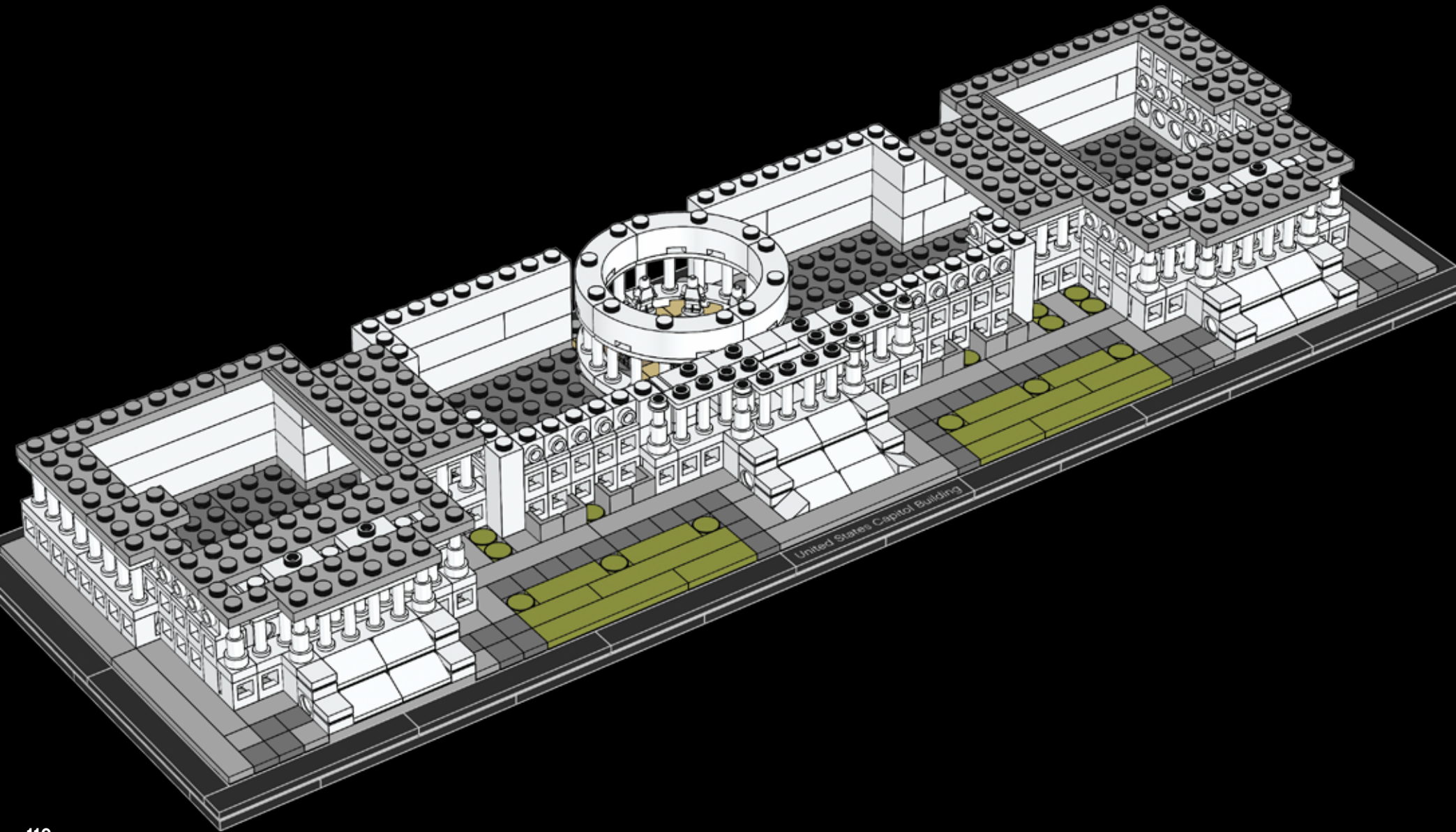

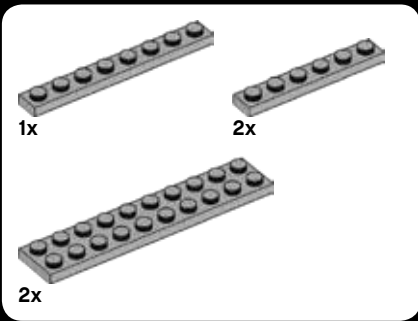

112

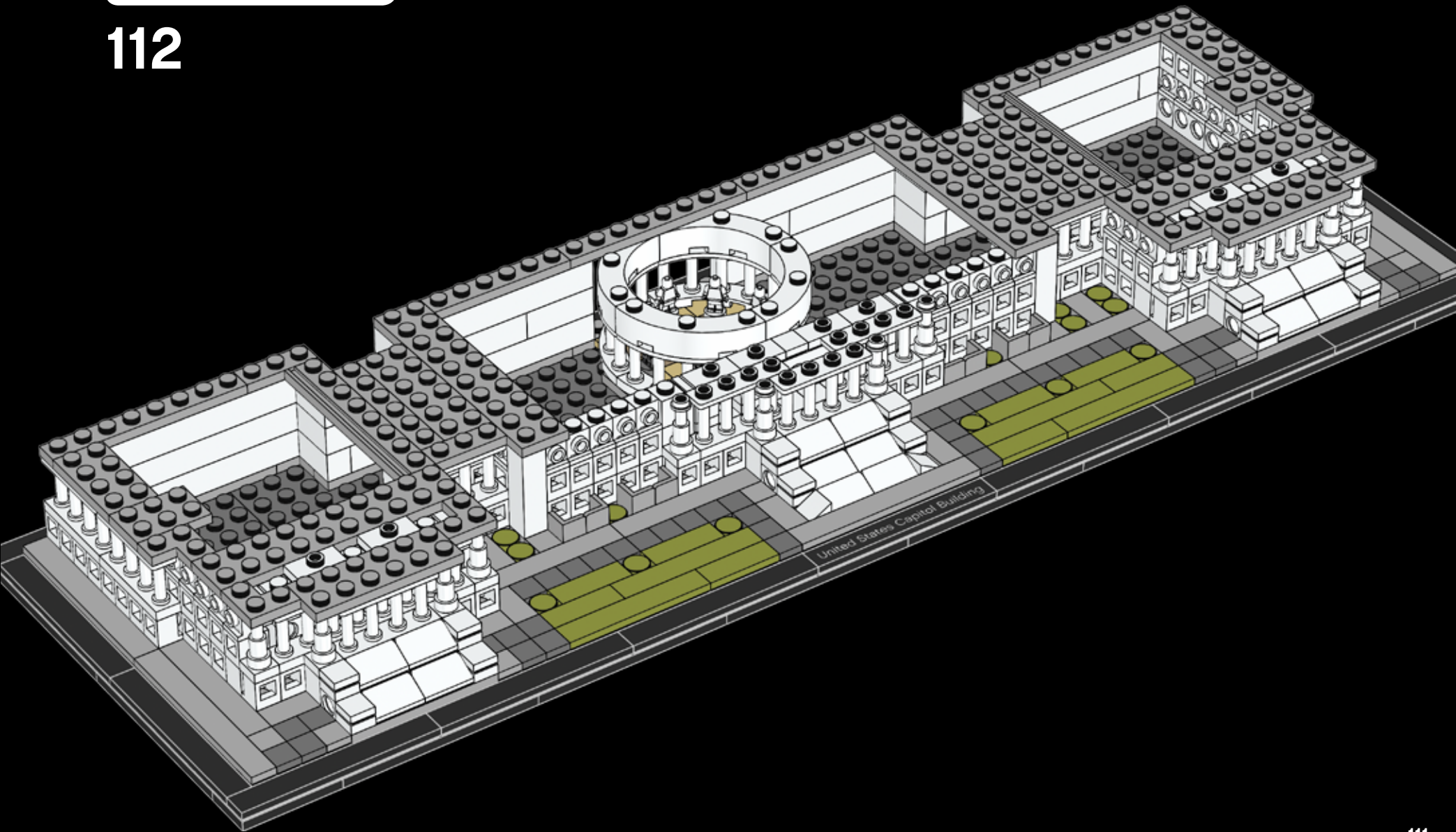

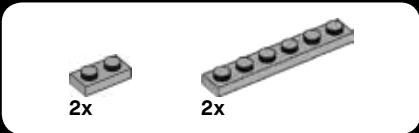

113

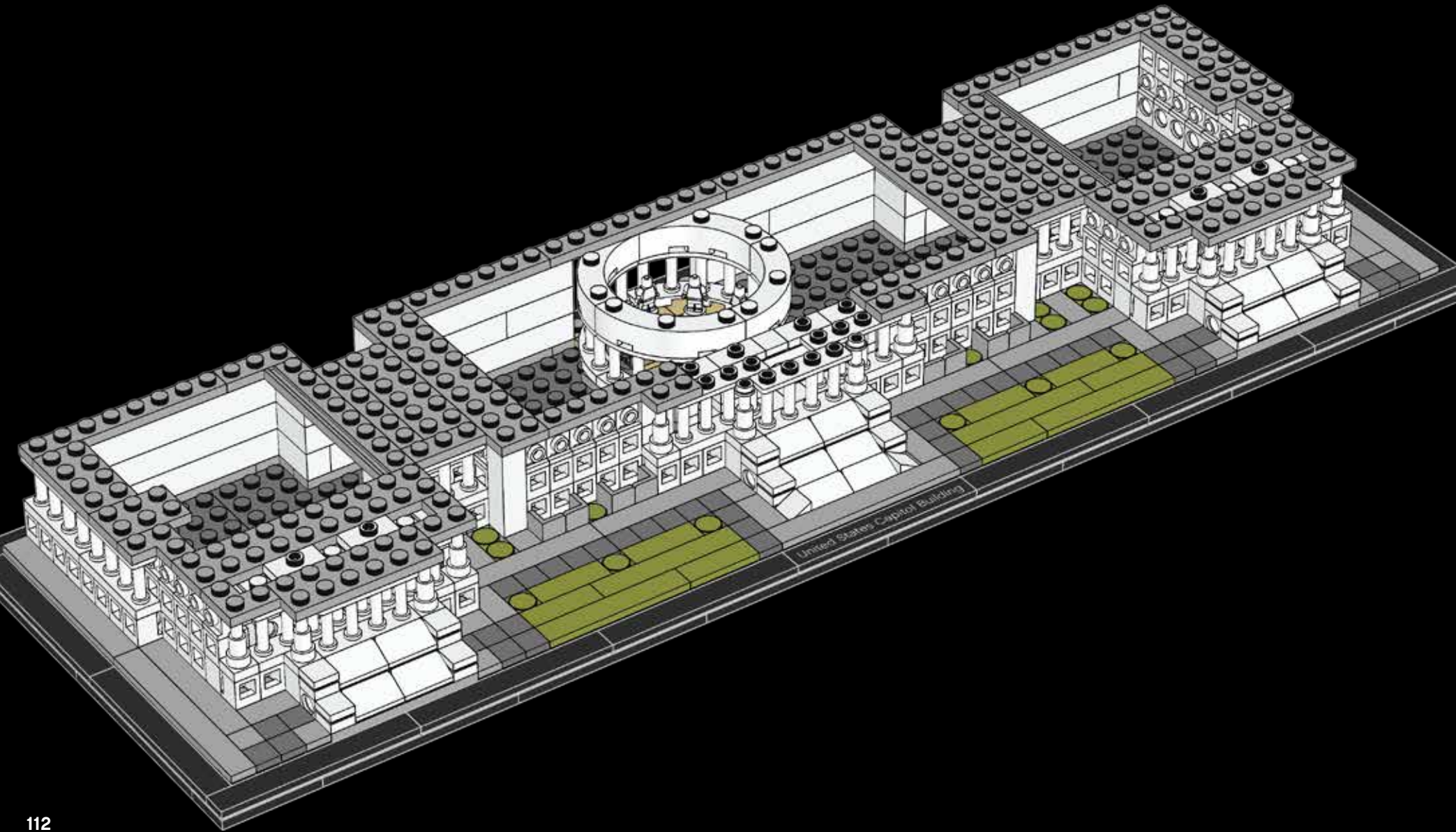



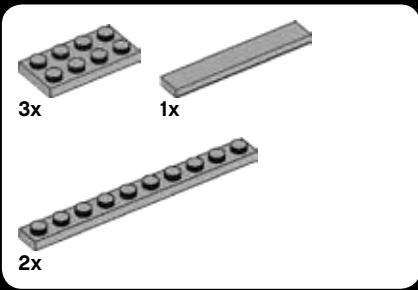

114

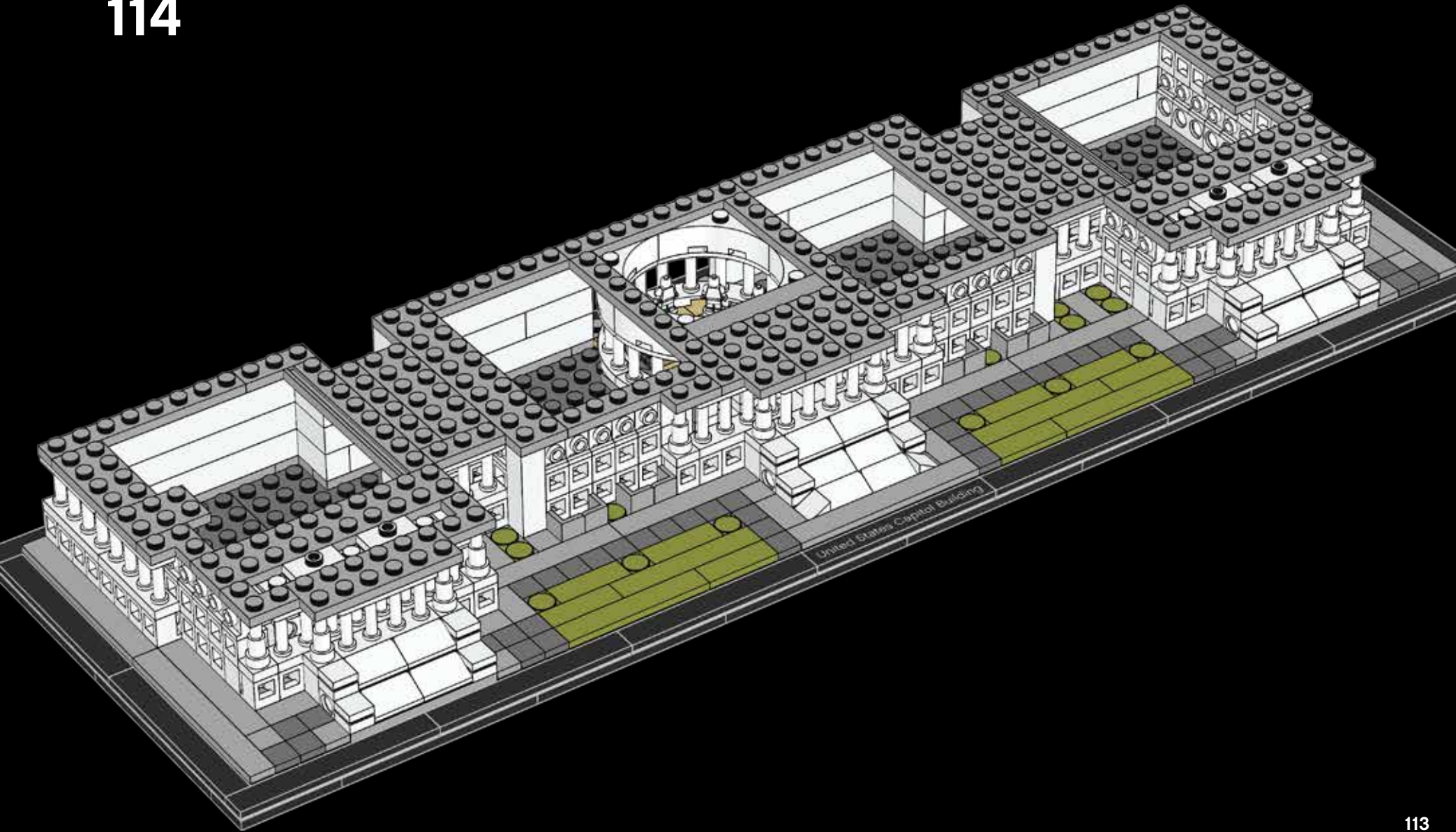

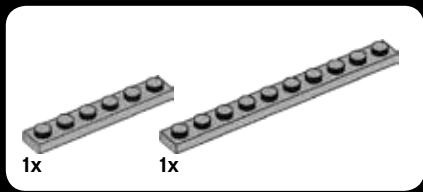

115

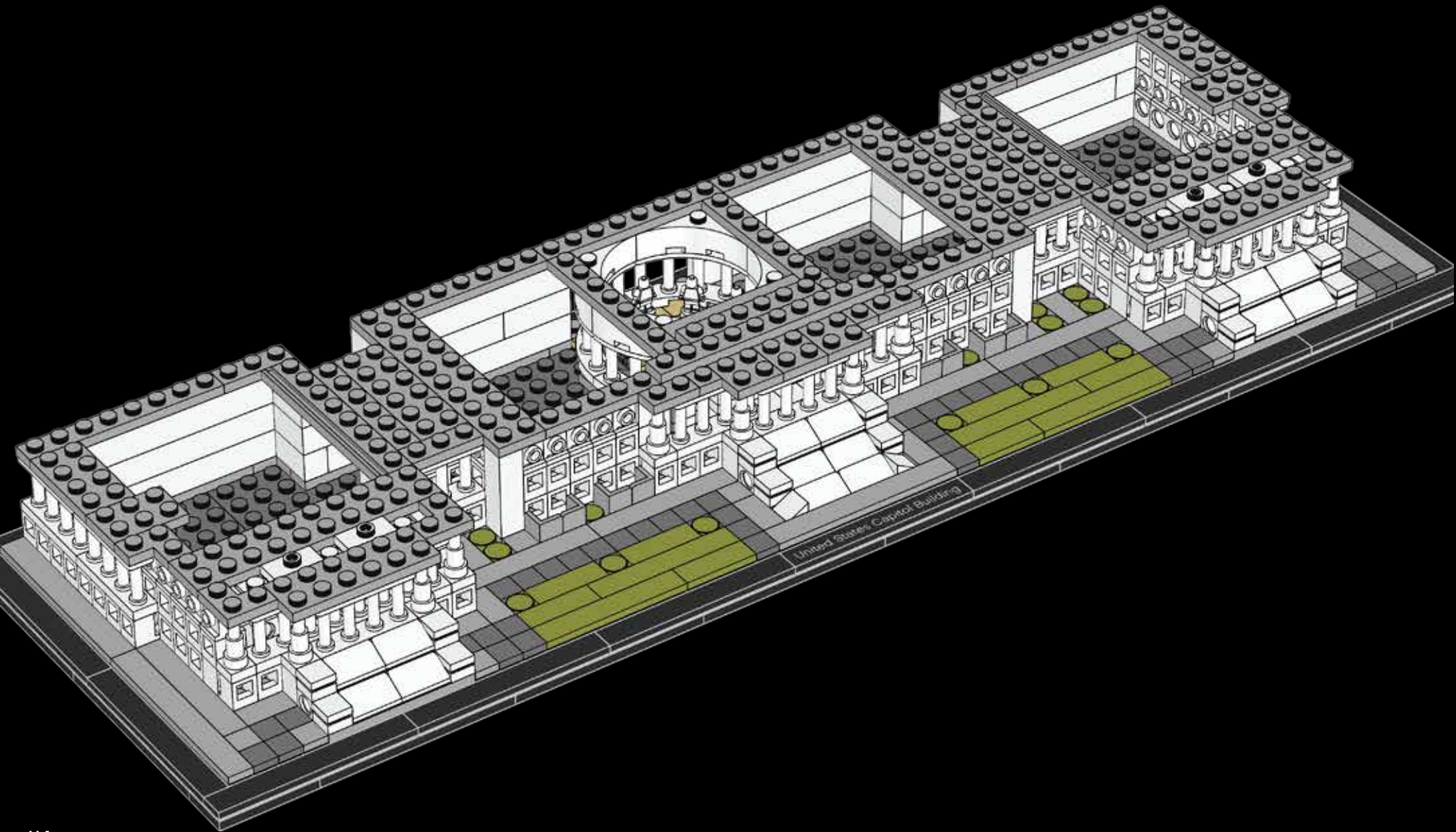

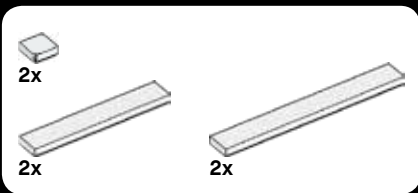

116

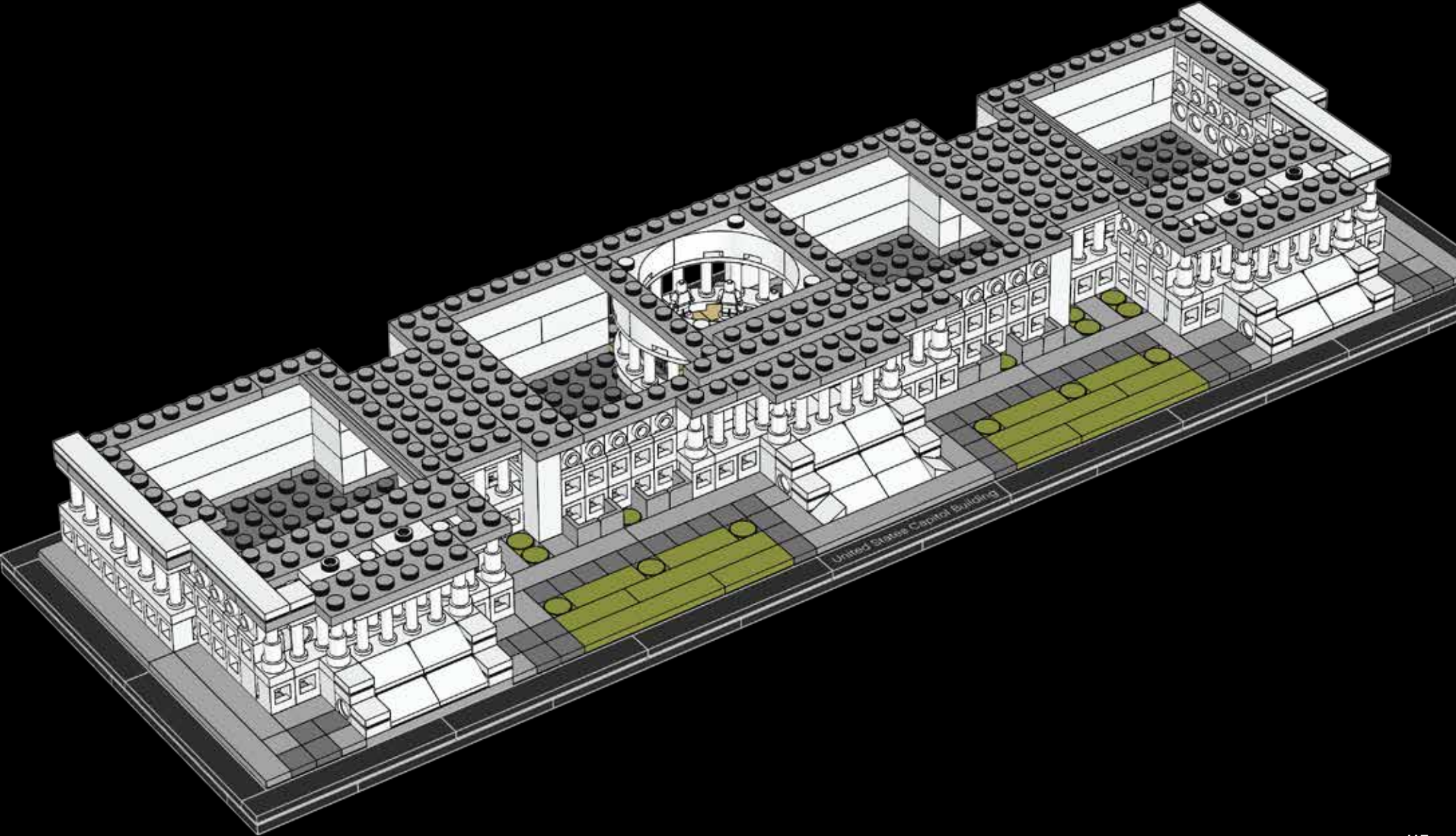

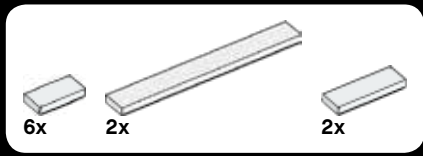

117

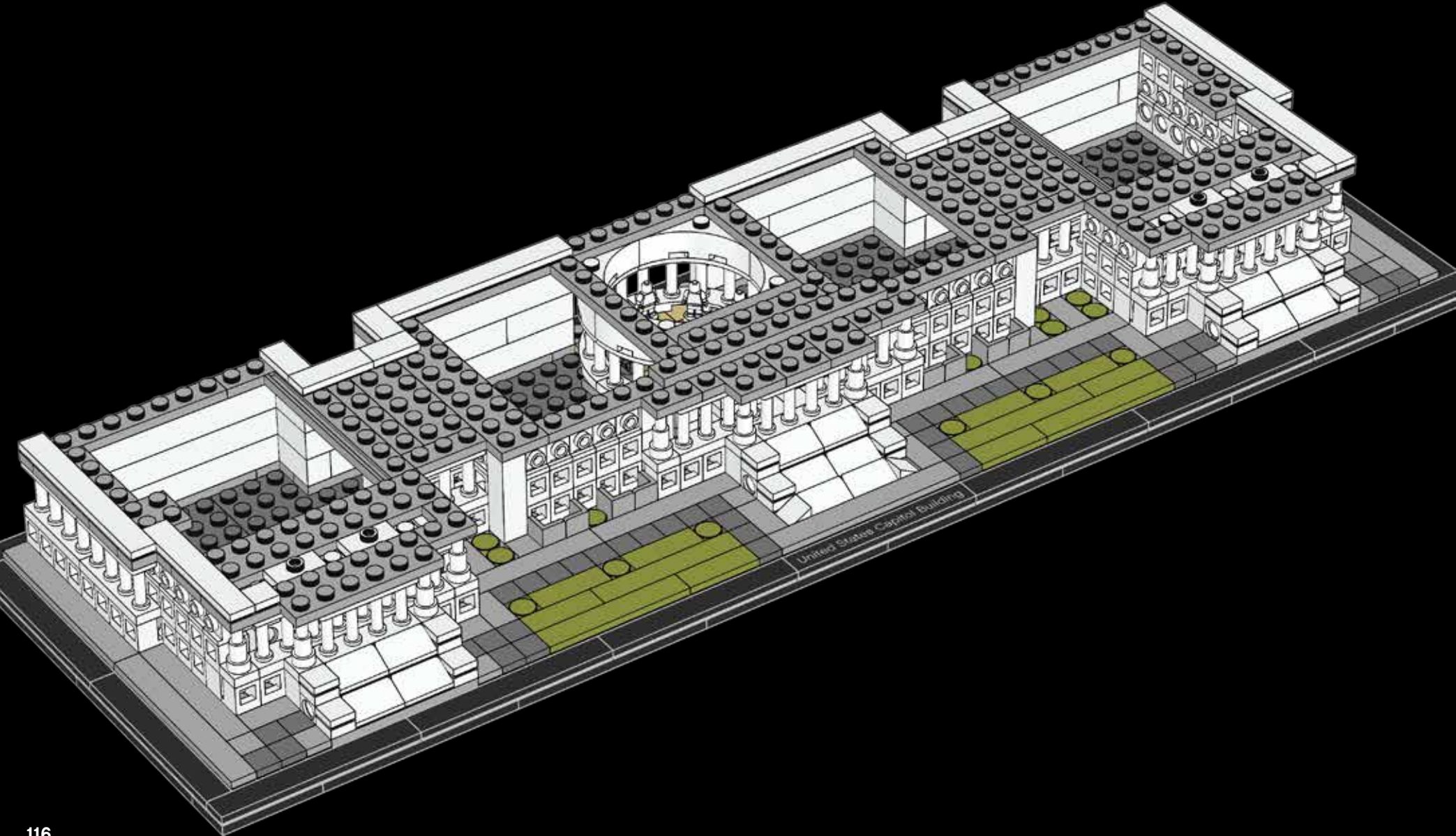

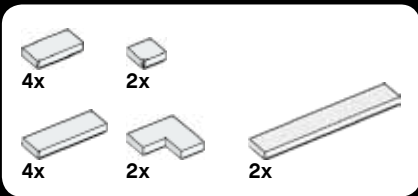

118

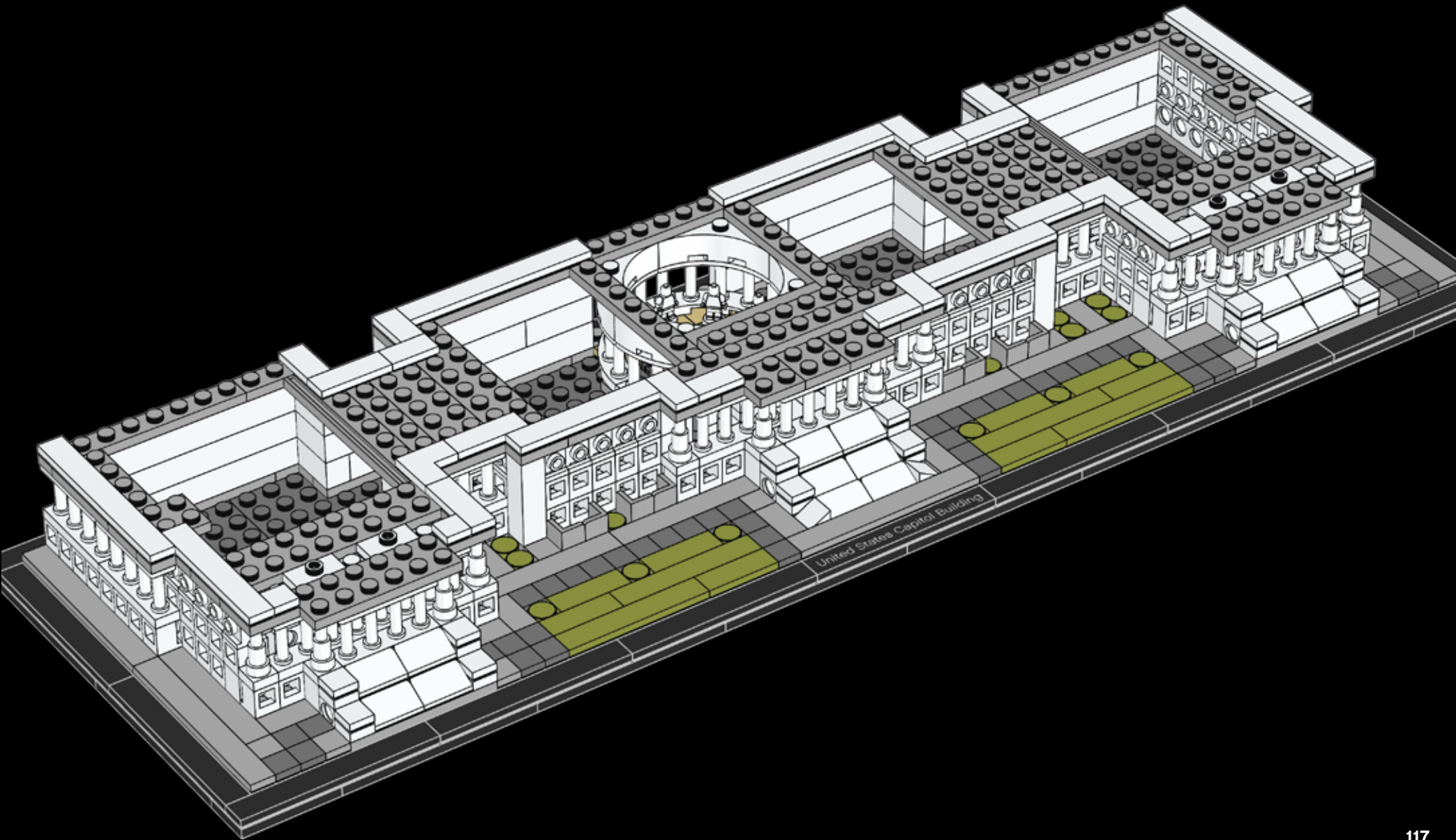



3x



6x

# 119

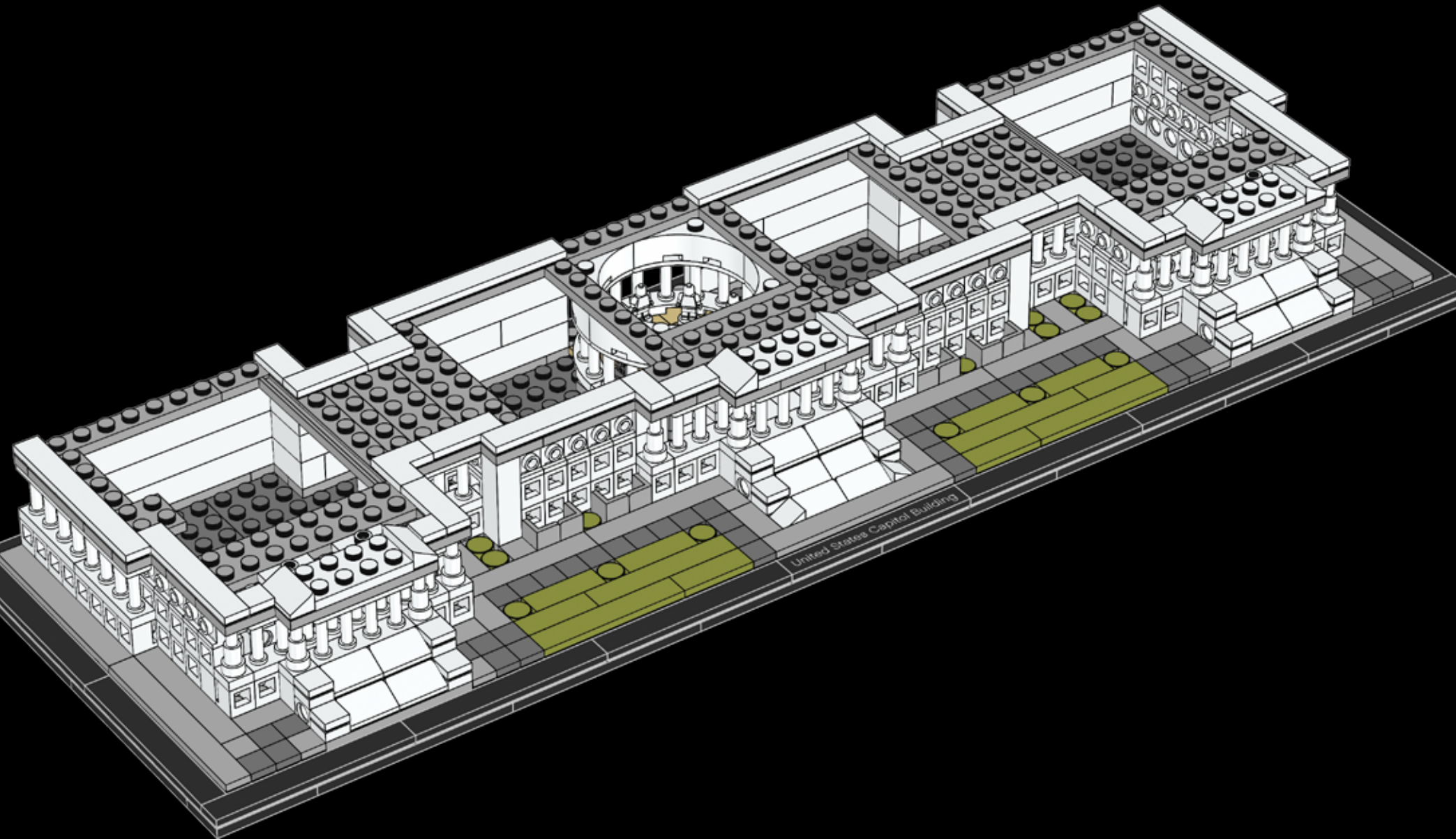

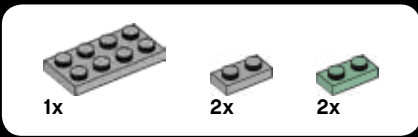

120

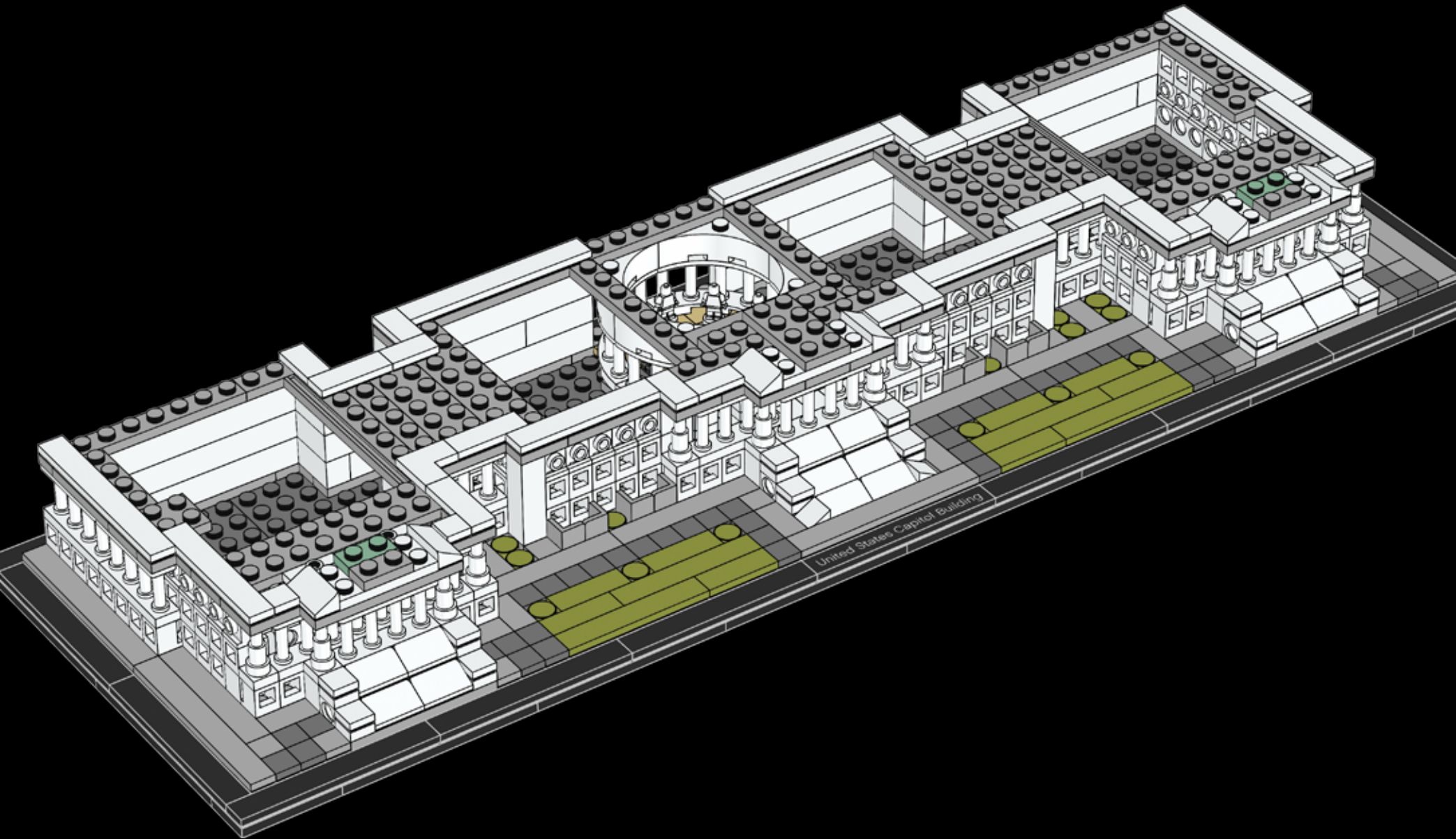



8x



8x

121

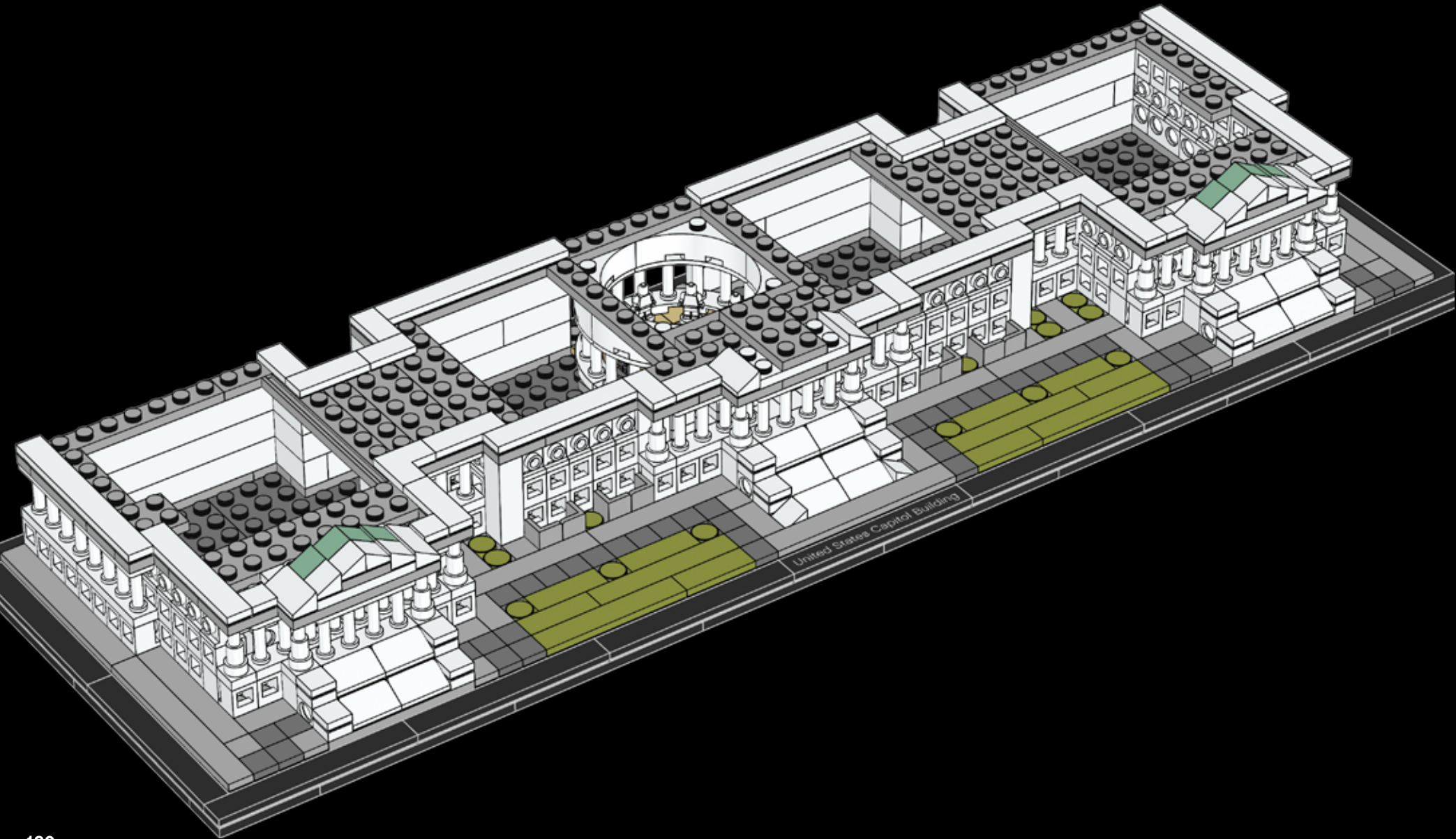





8x

# 122

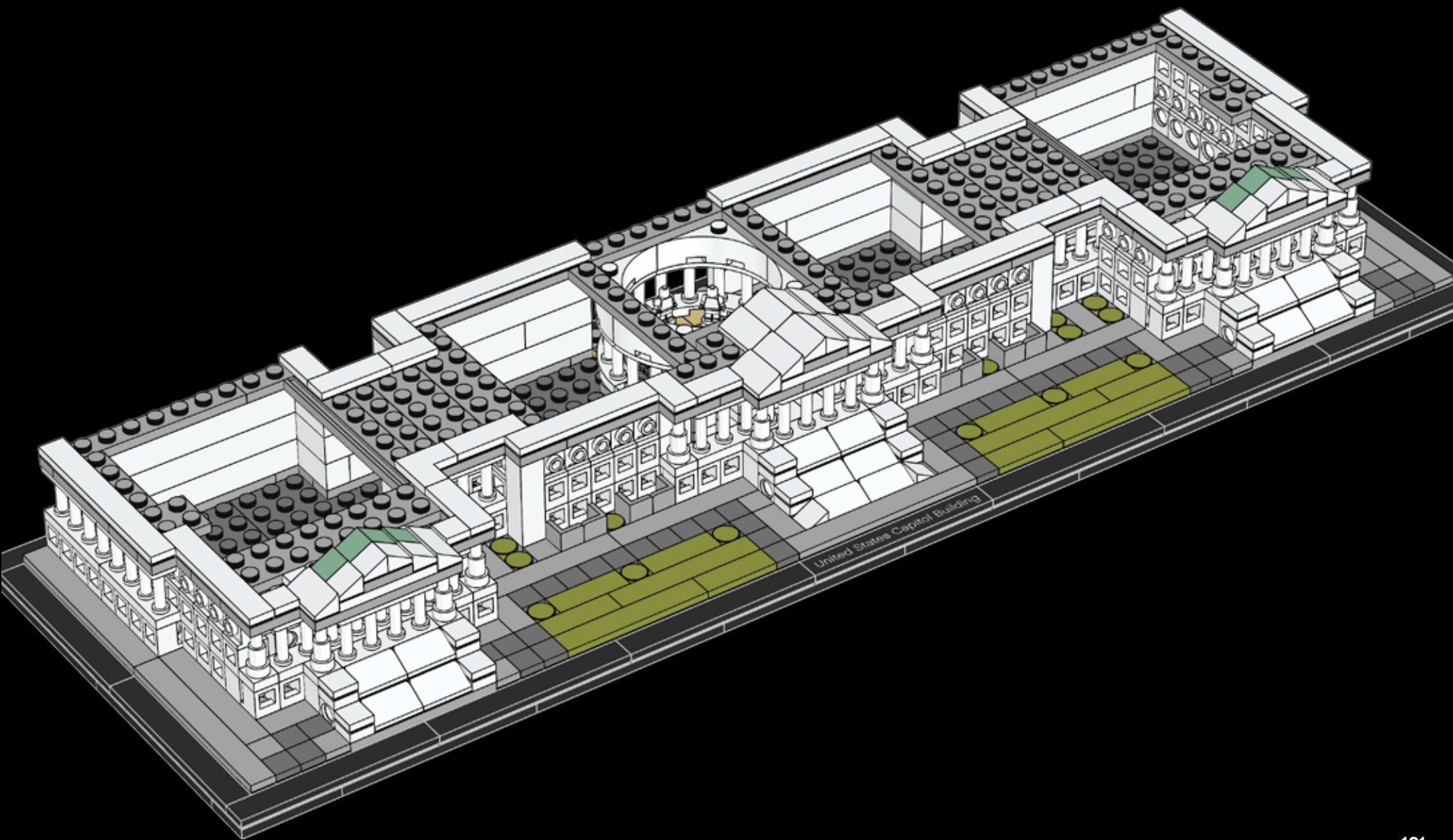



123

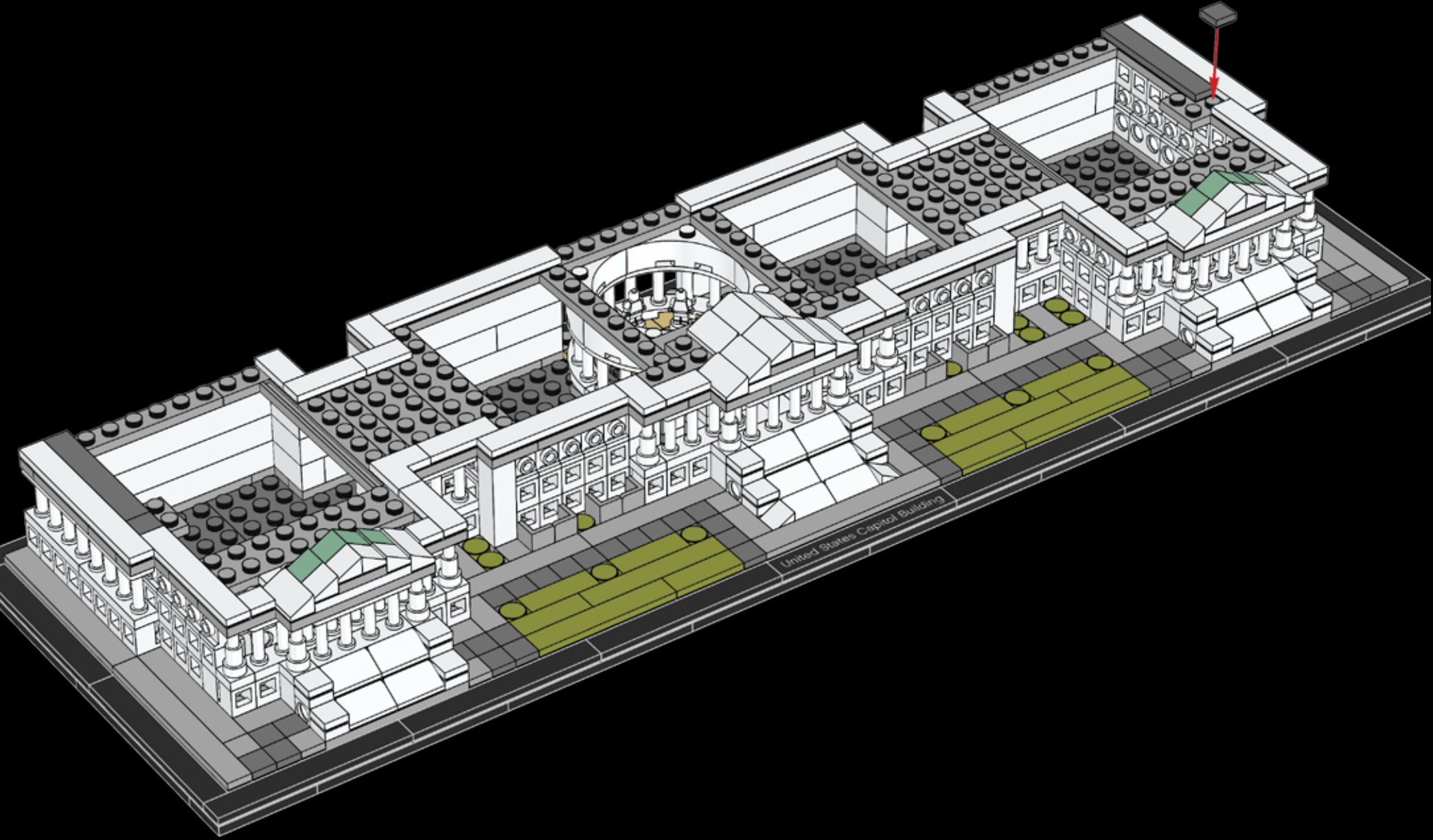



2x



2x

# 124

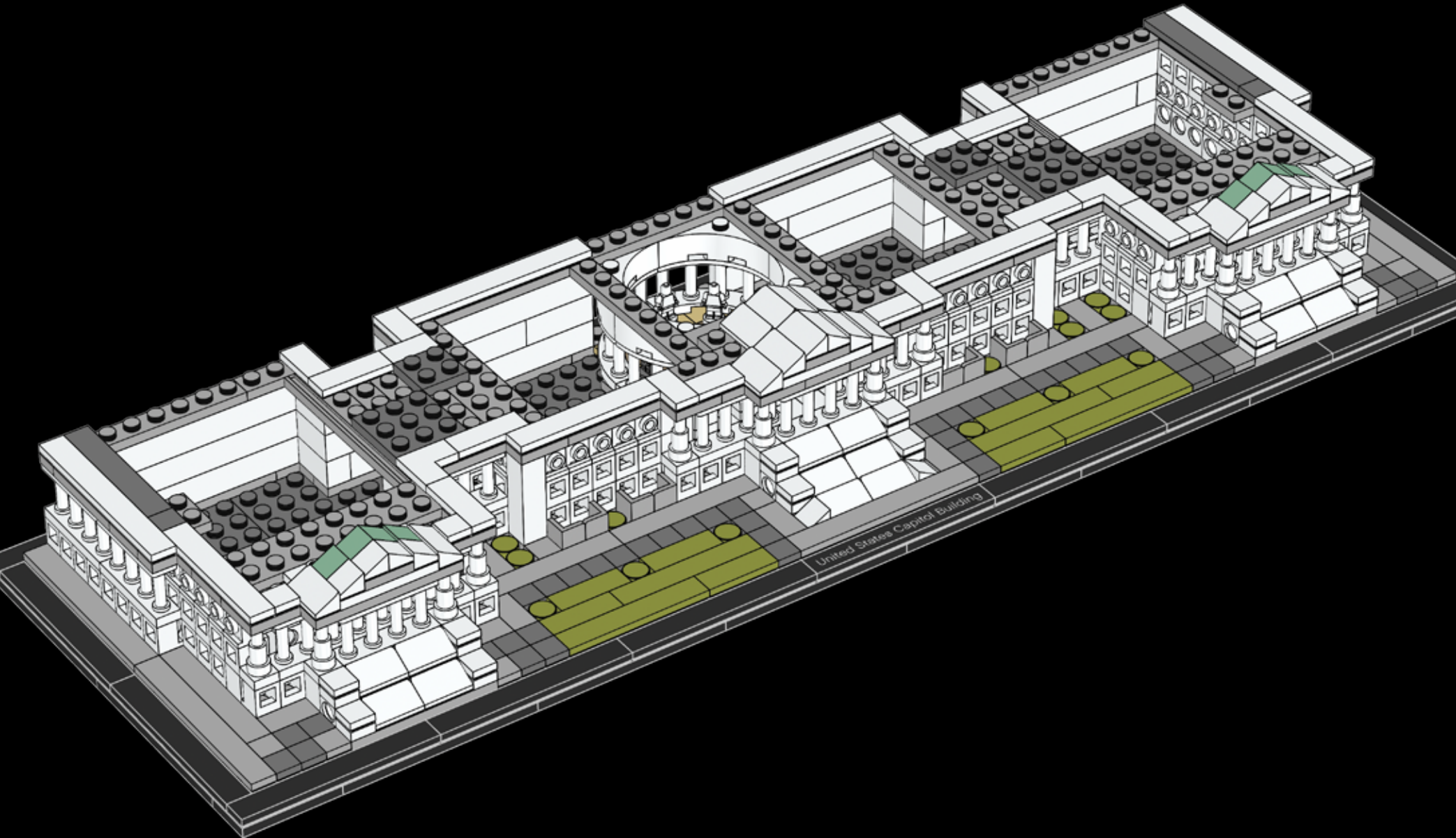



4x

125

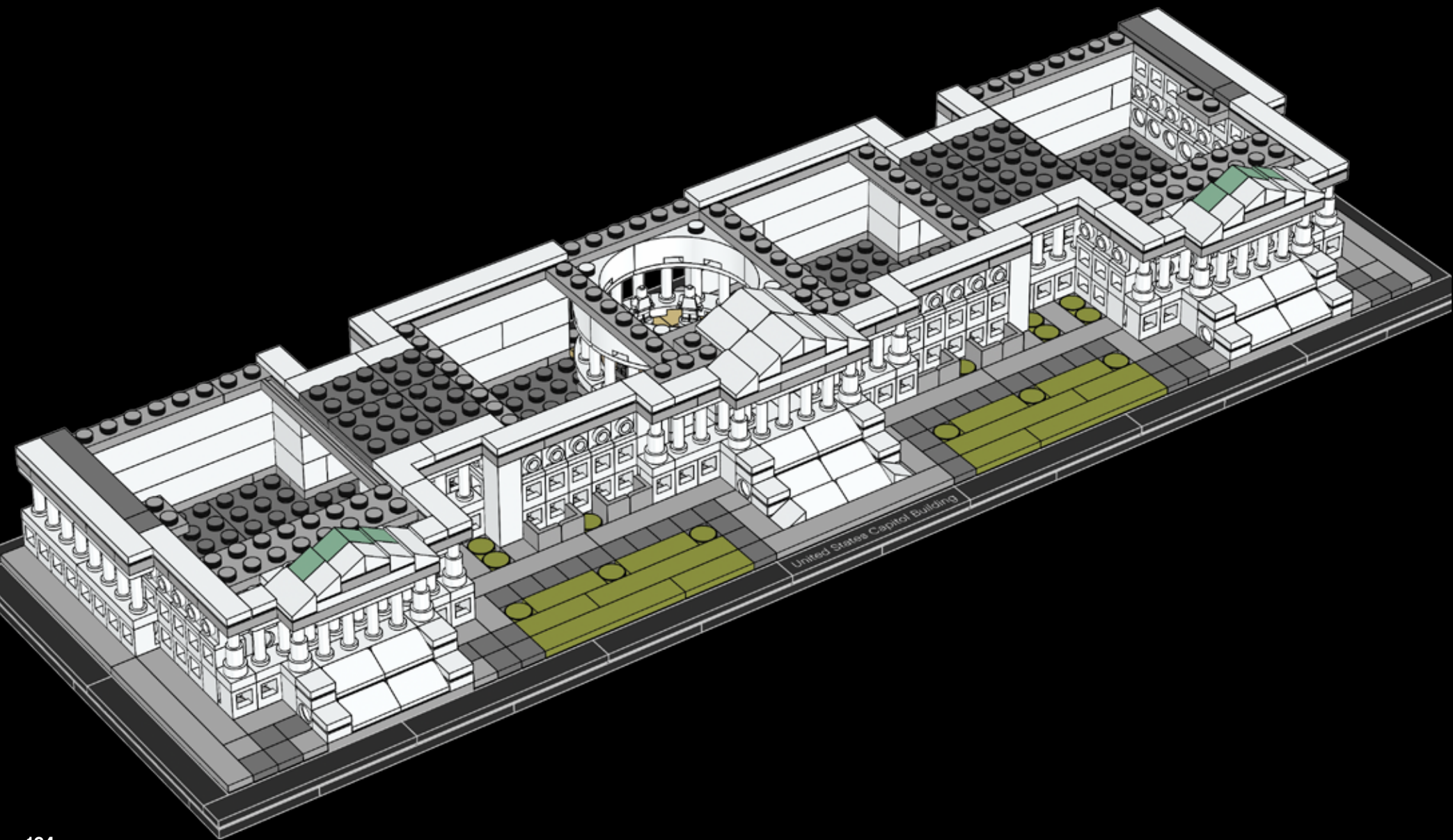

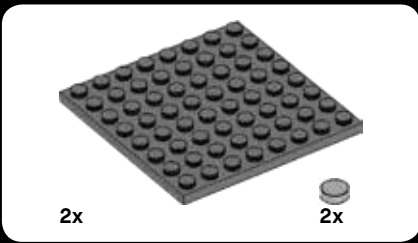

126

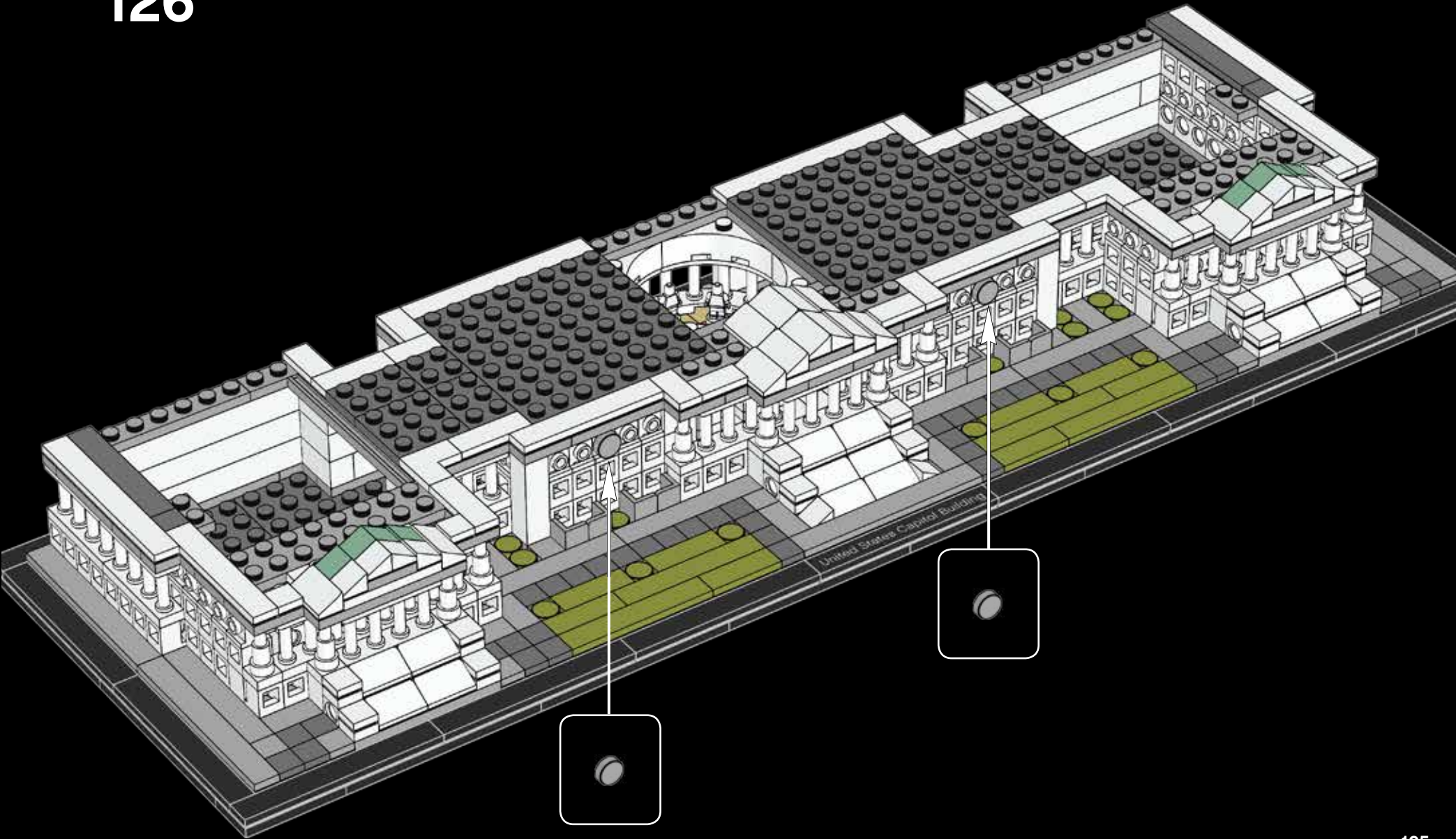



127

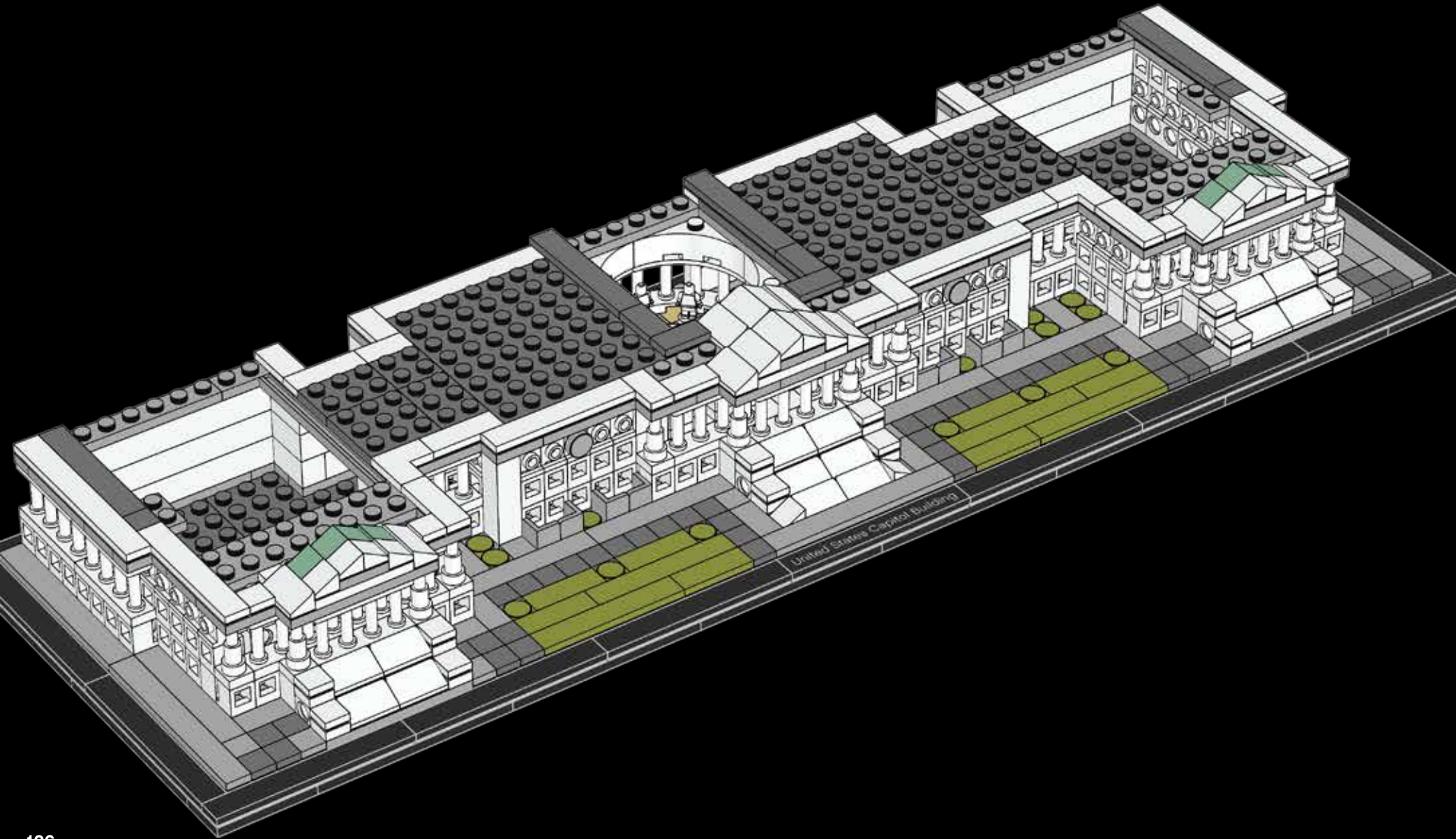



20x

# 128

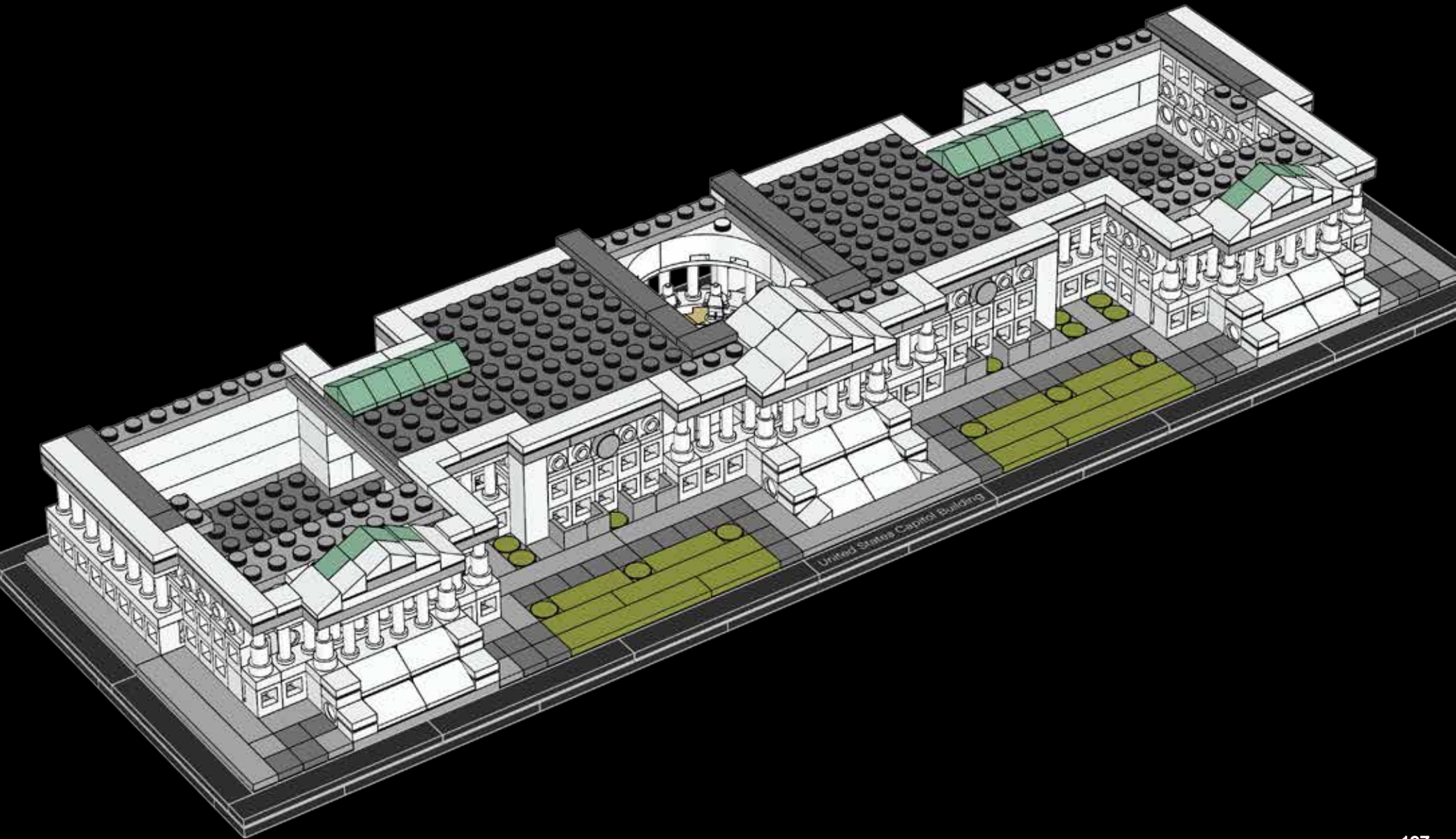



10x

129

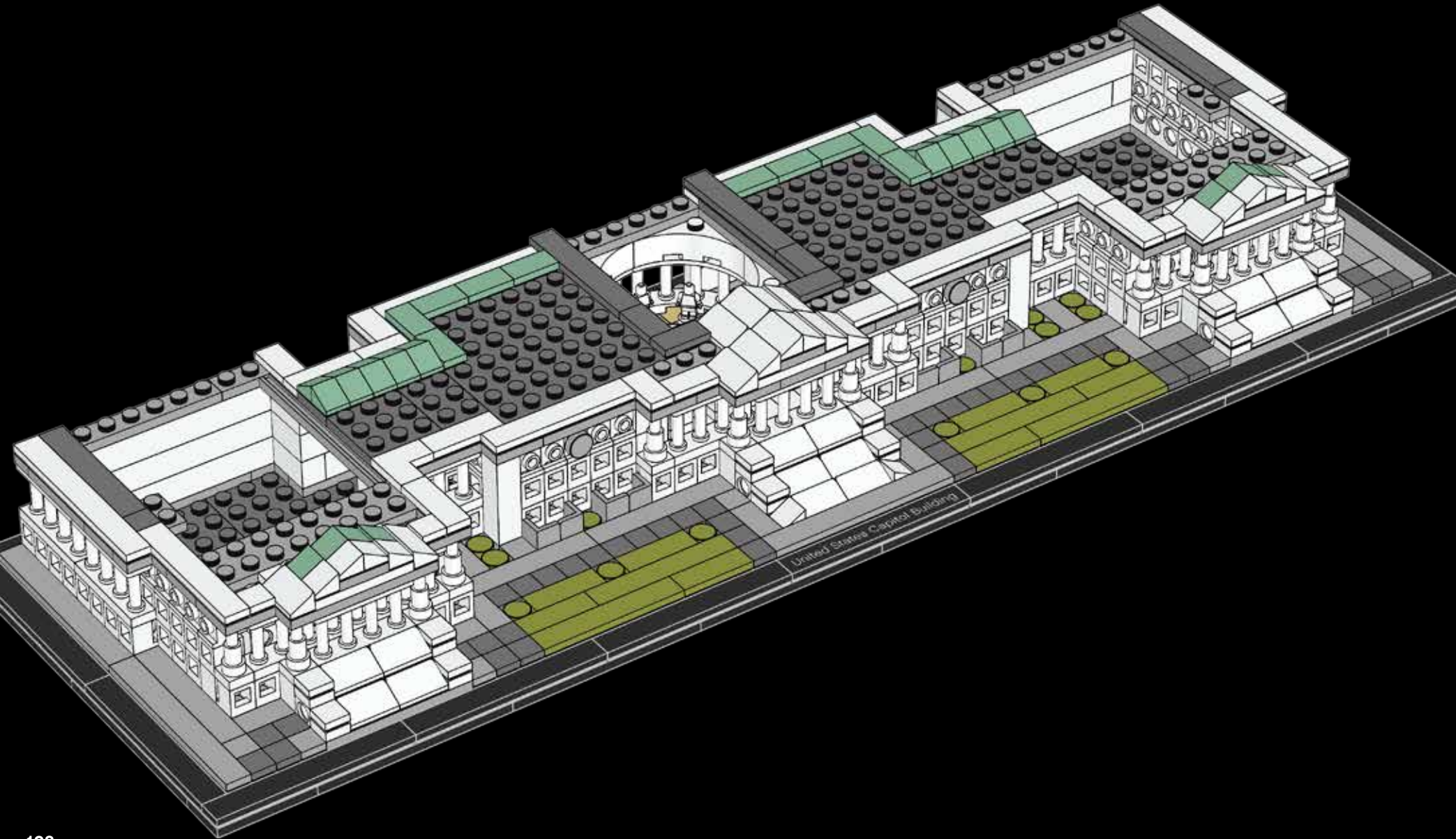



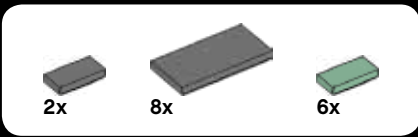

130

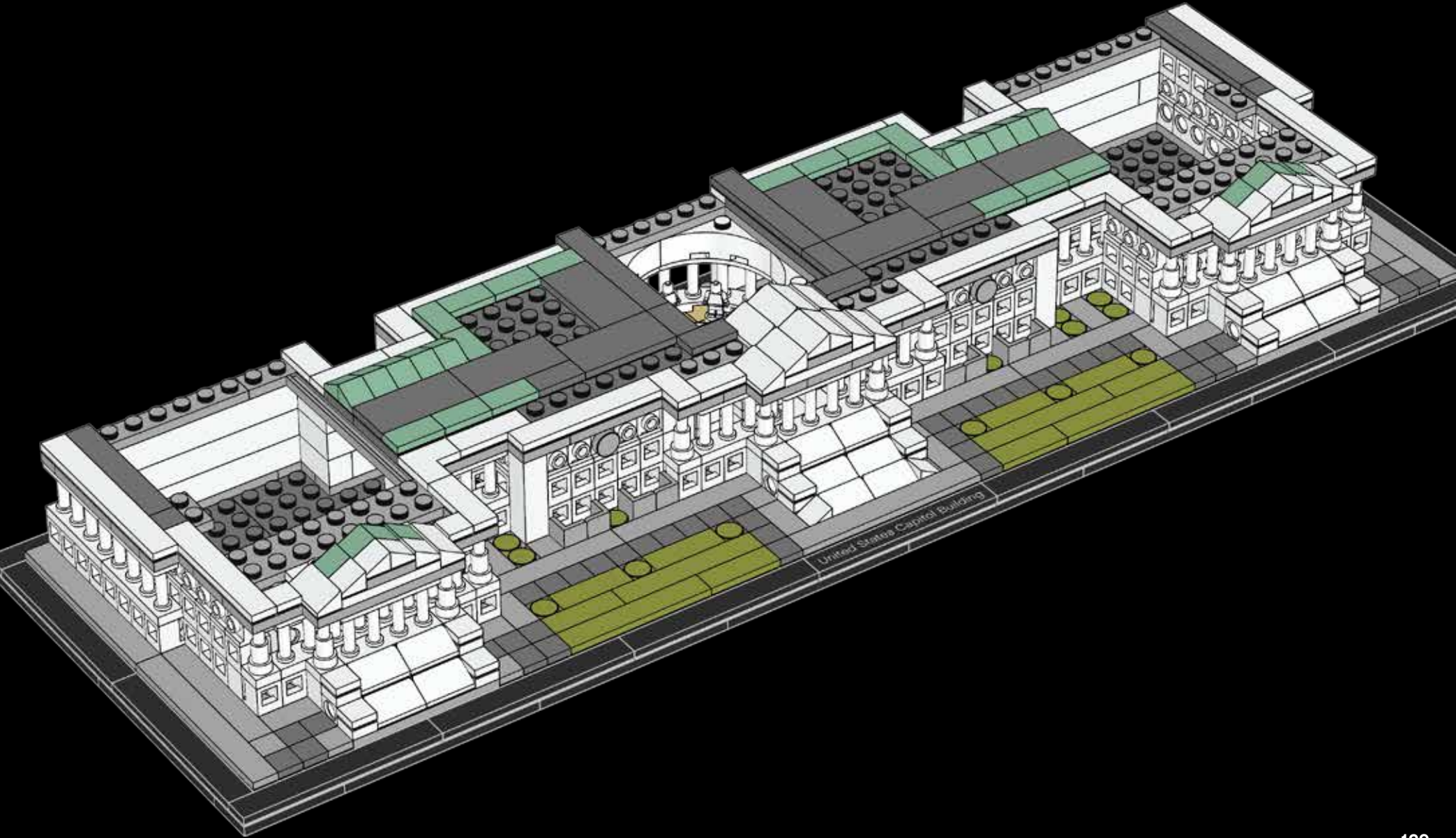



10x

131

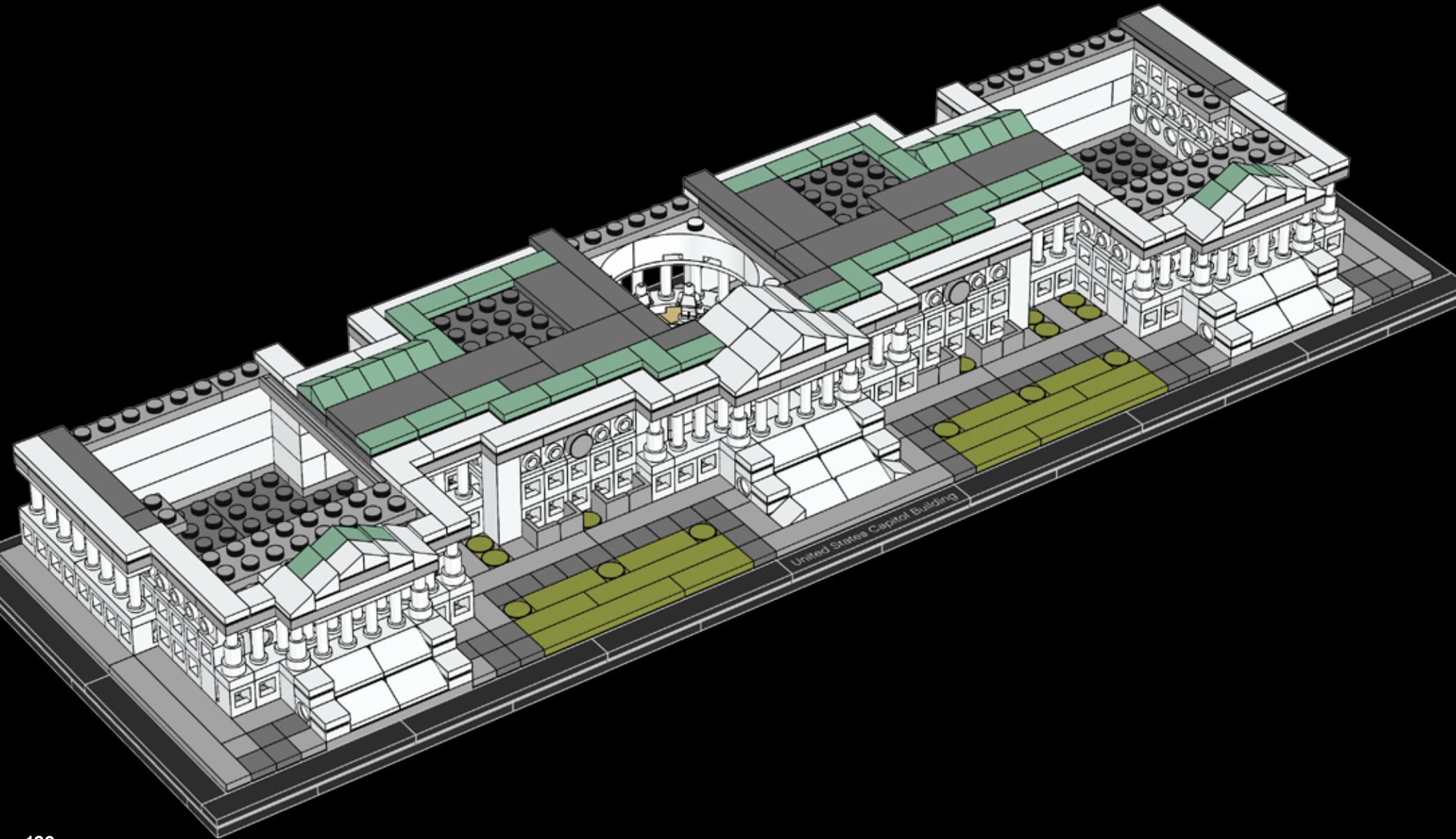

130



4x

# 132

The building's dome is made of 8,909,200 lb. (4,041,100 kg) of cast iron.

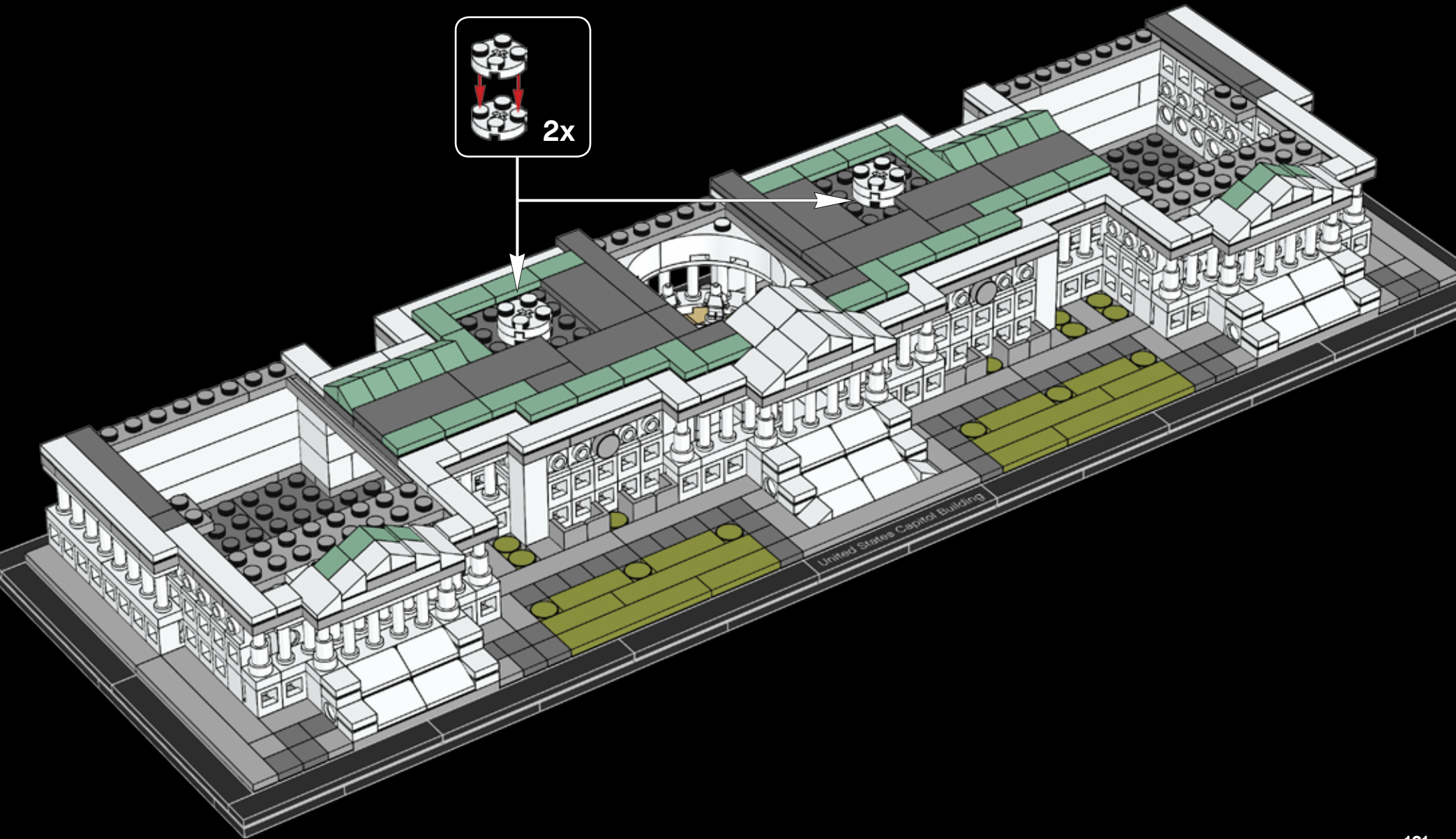
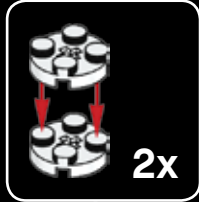



2x

133

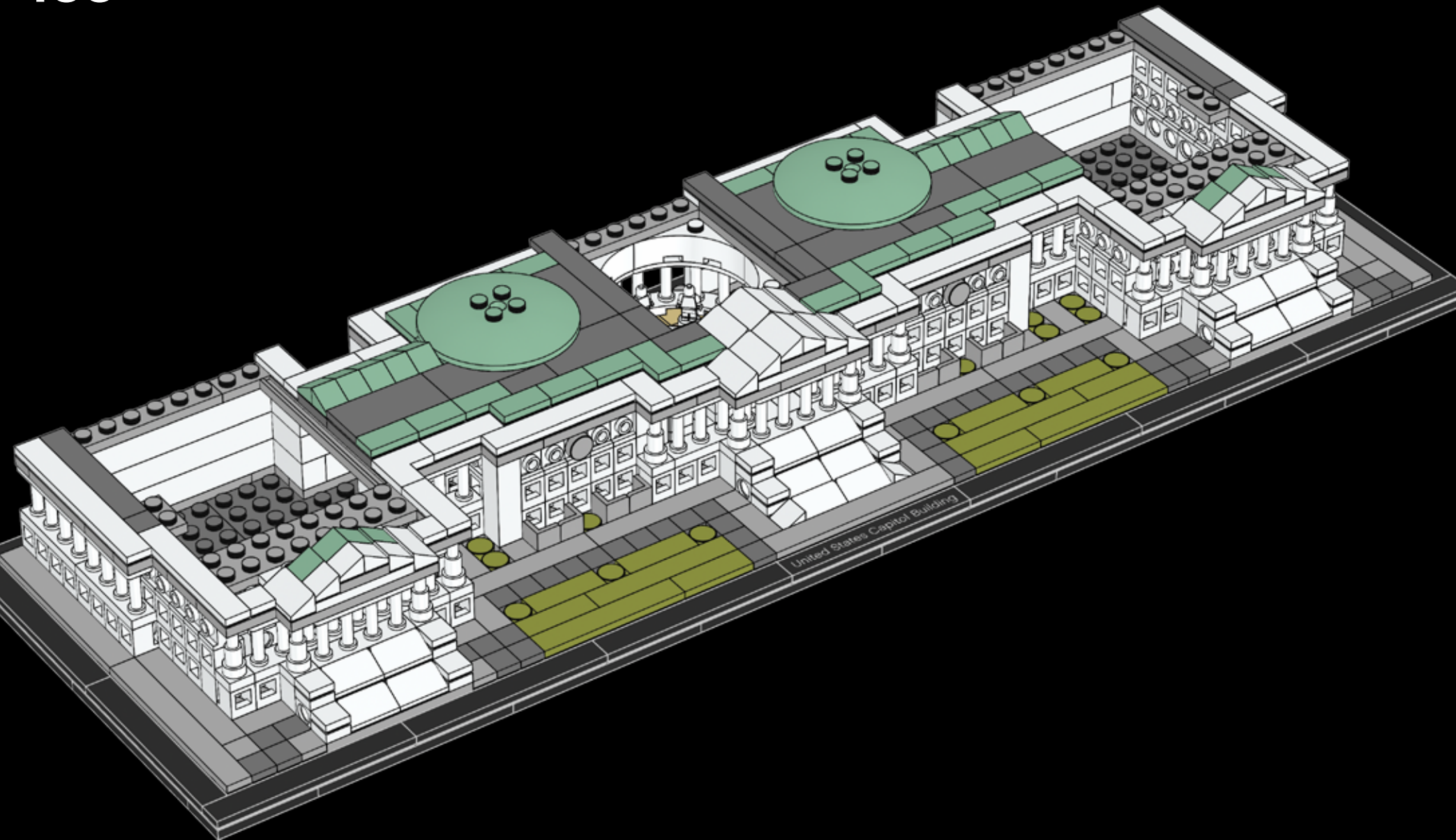



2x



2x

# 134

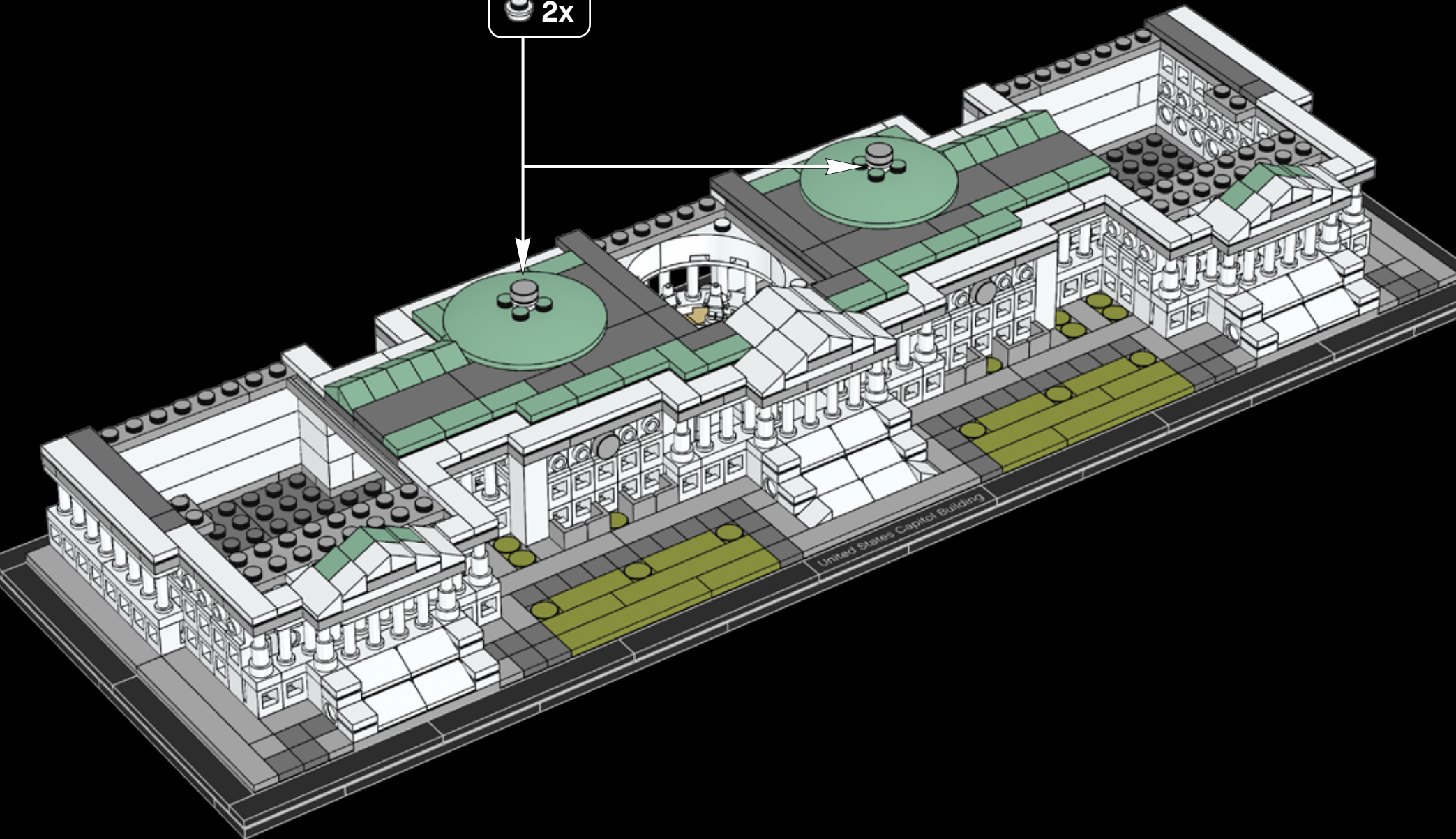
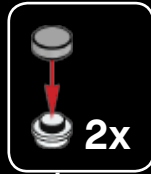



135

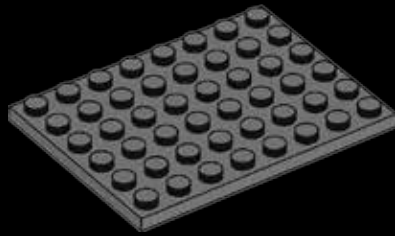

136

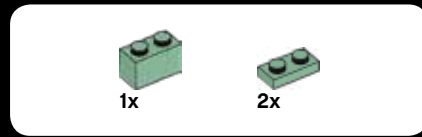
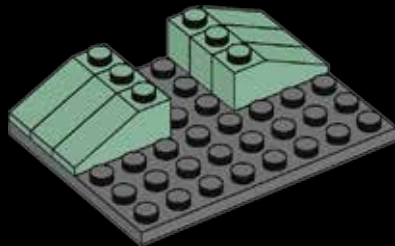

137

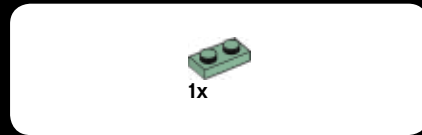
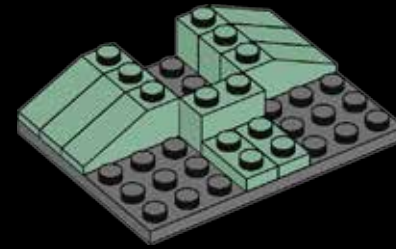

138

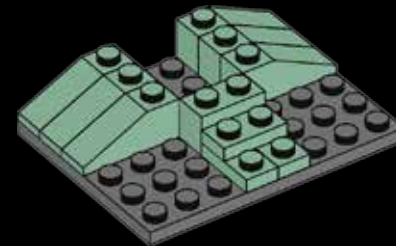



1x

# 139

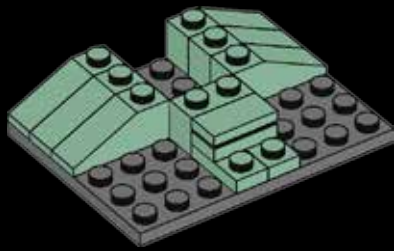

2x

# 140

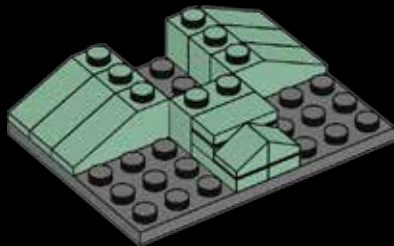

2x

# 141

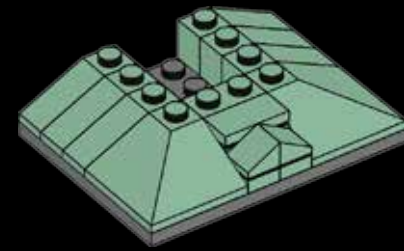

2x

# 142

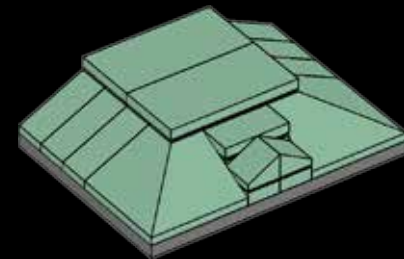

# 2x

143

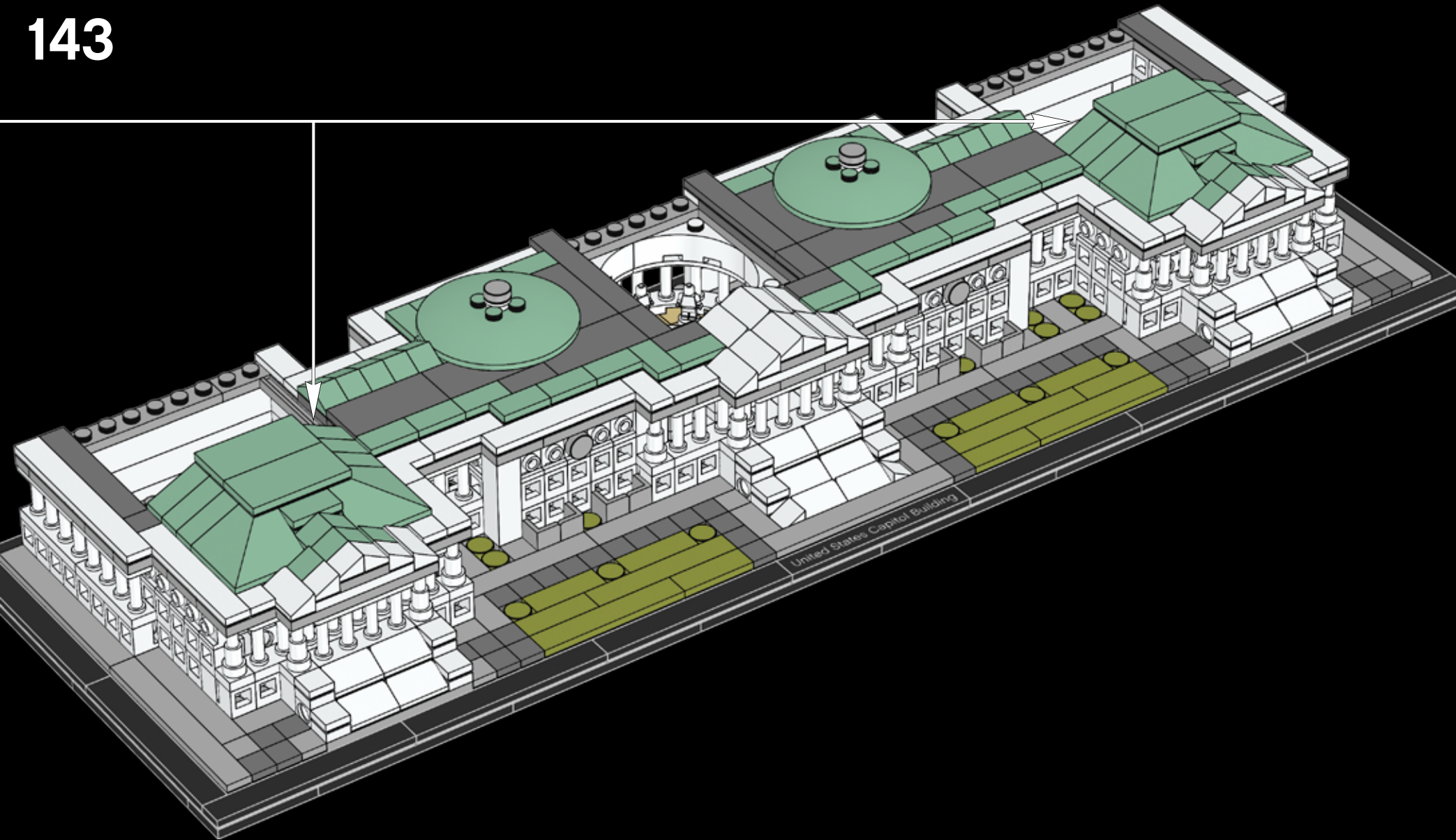





144

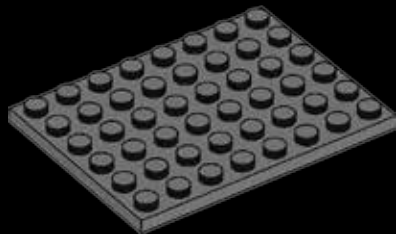

145

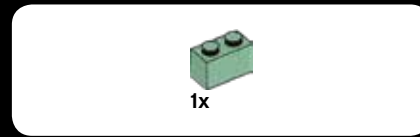
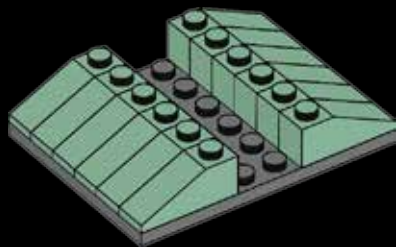

146

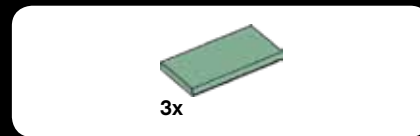
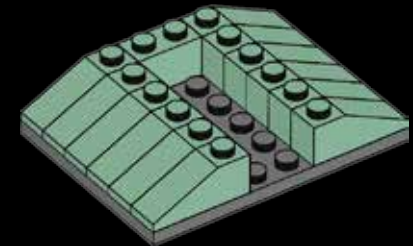

147

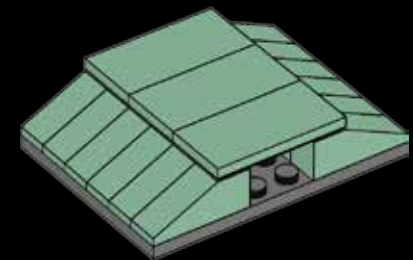

148

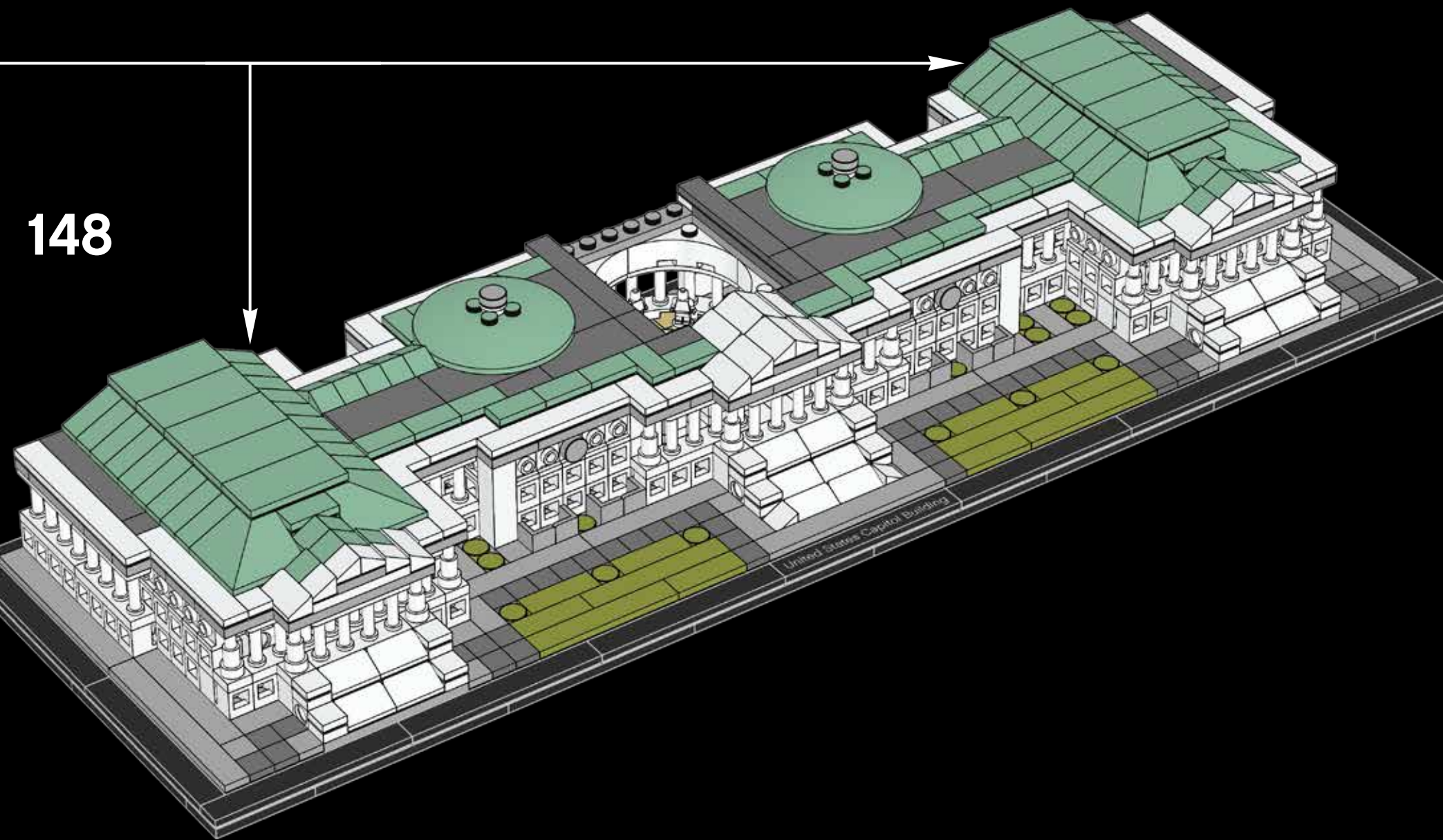

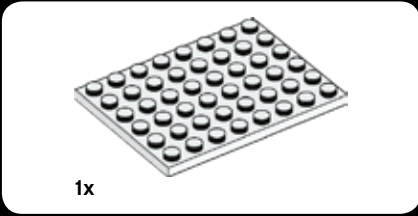
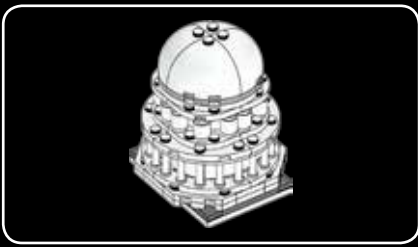

1x

149

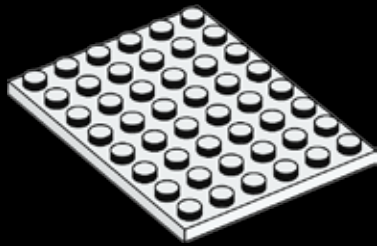

4x

150

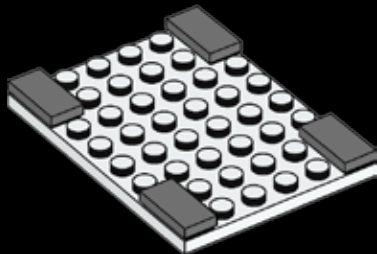

1x

151

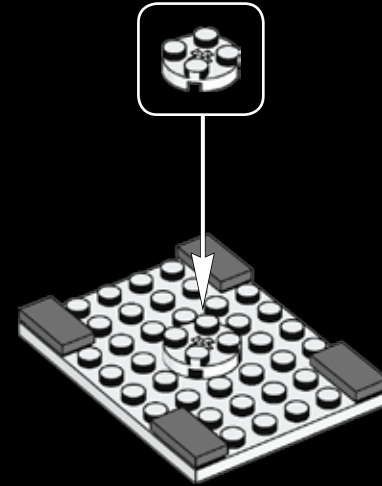

4x

152

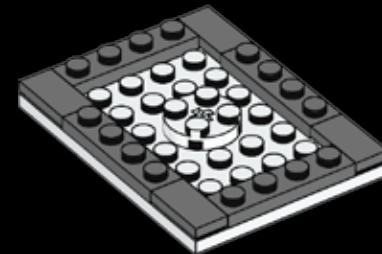



2x



2x

# 153

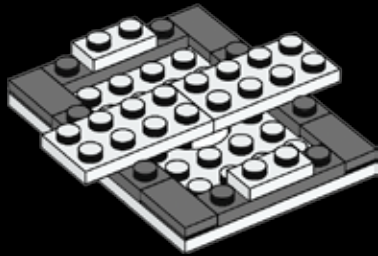

8x

# 154

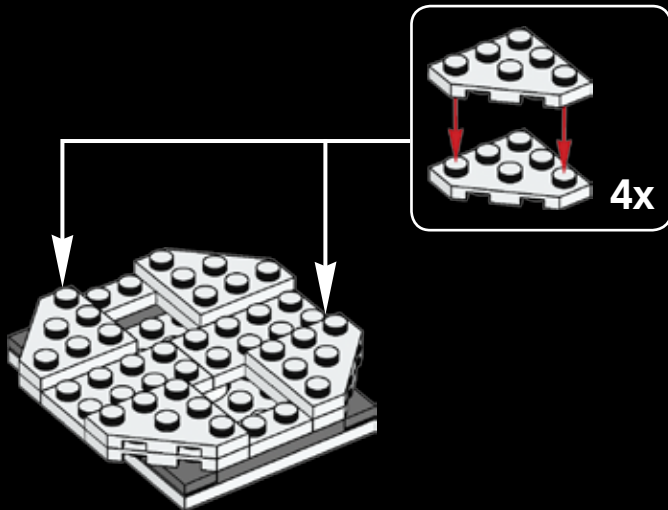

4x

# 155

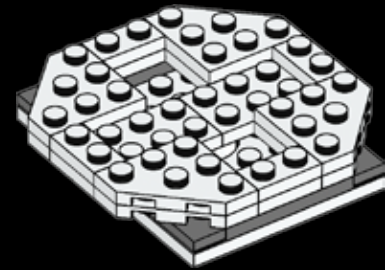

1x



1x

# 156

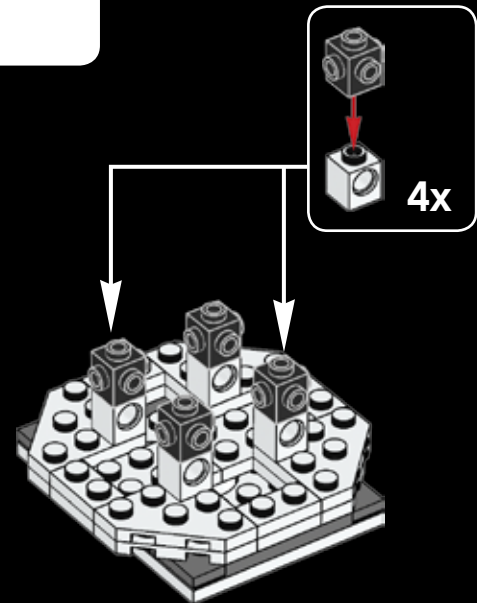



4x



8x

# 157

1



2



4x

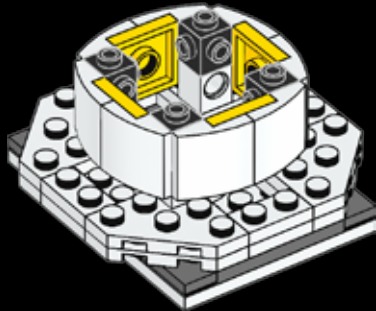

4x

# 158

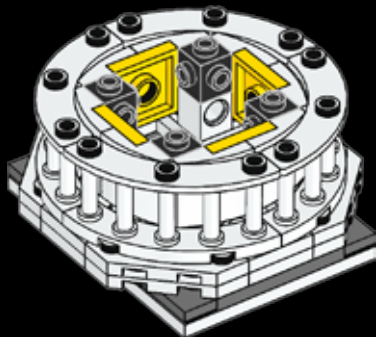

4x

# 159

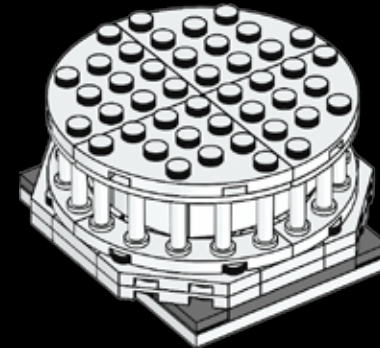

4x

# 160

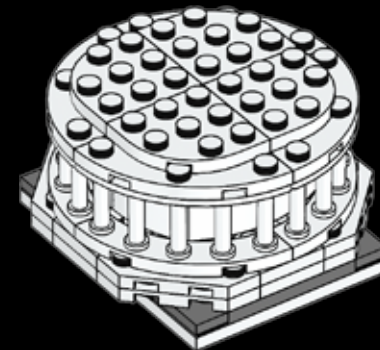

The current "wedding-cake style" cast-iron dome was added in 1855 and is three times the height of the original one.





1x

# 161

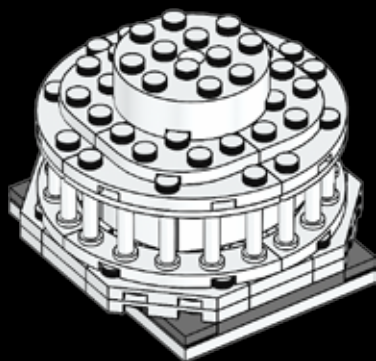

1x

# 162

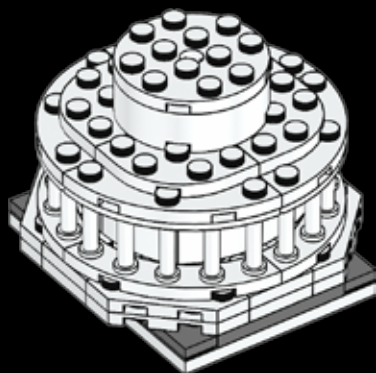

4x



12x



12x

# 163

1



2

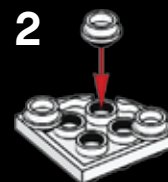

3



4x

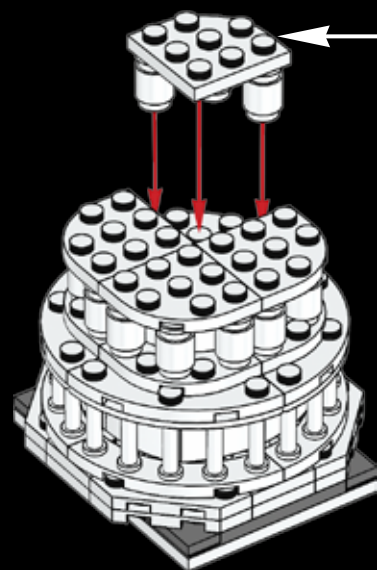



1x

# 164

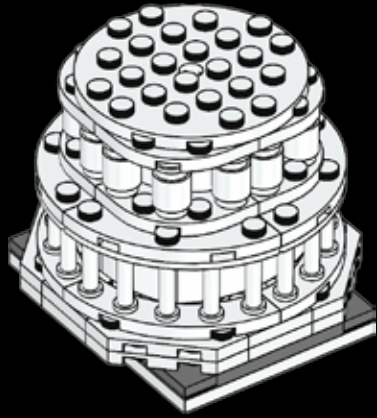

1x

# 165

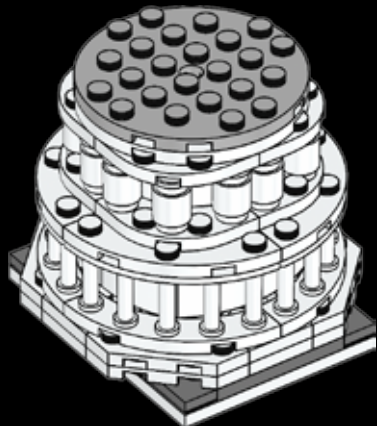

4x

# 166

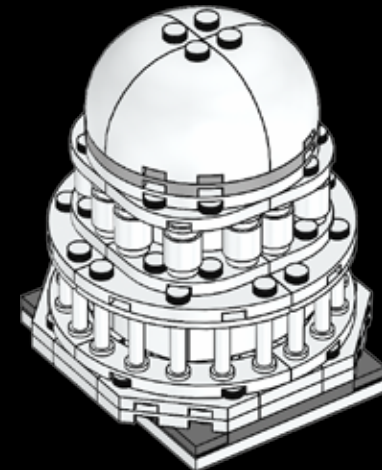

167

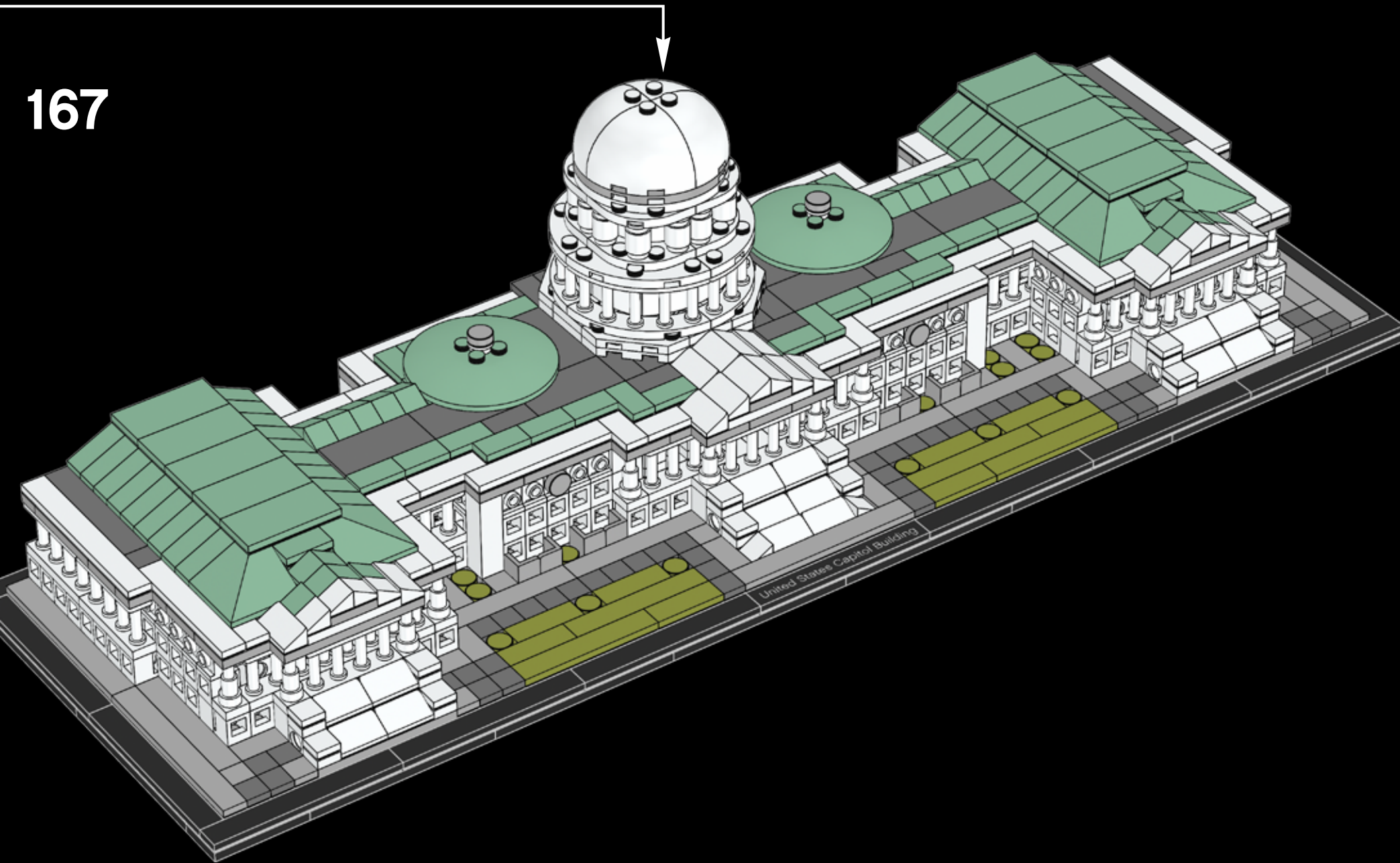



The statue at the top of the dome is entitled the Statue of Freedom.

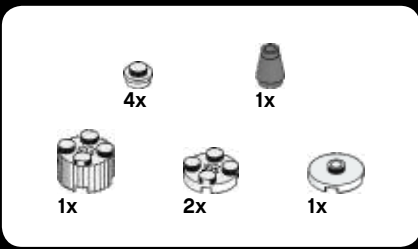

# 168

**1**



**2**



**3**



**4**



**5**



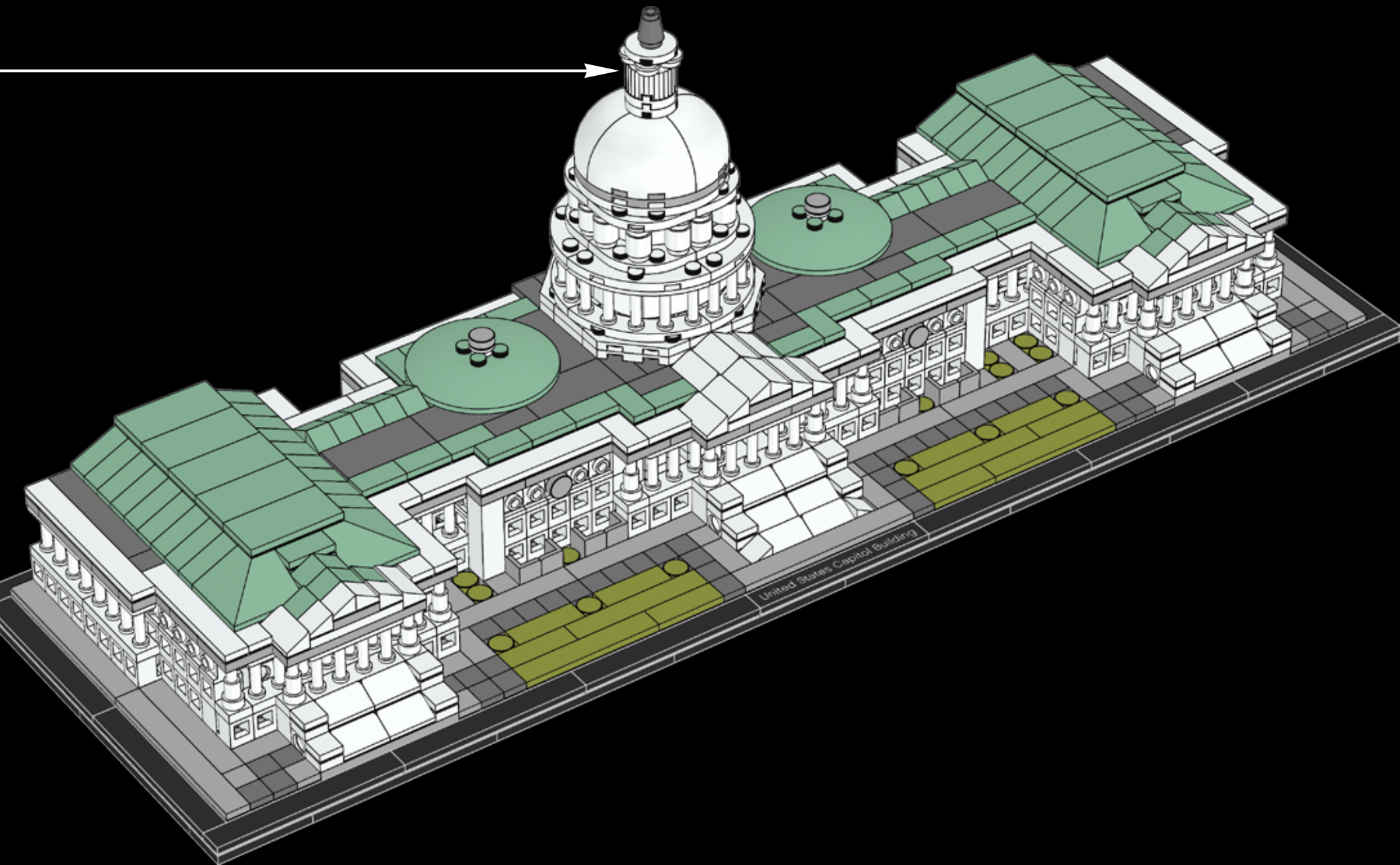



1x

169

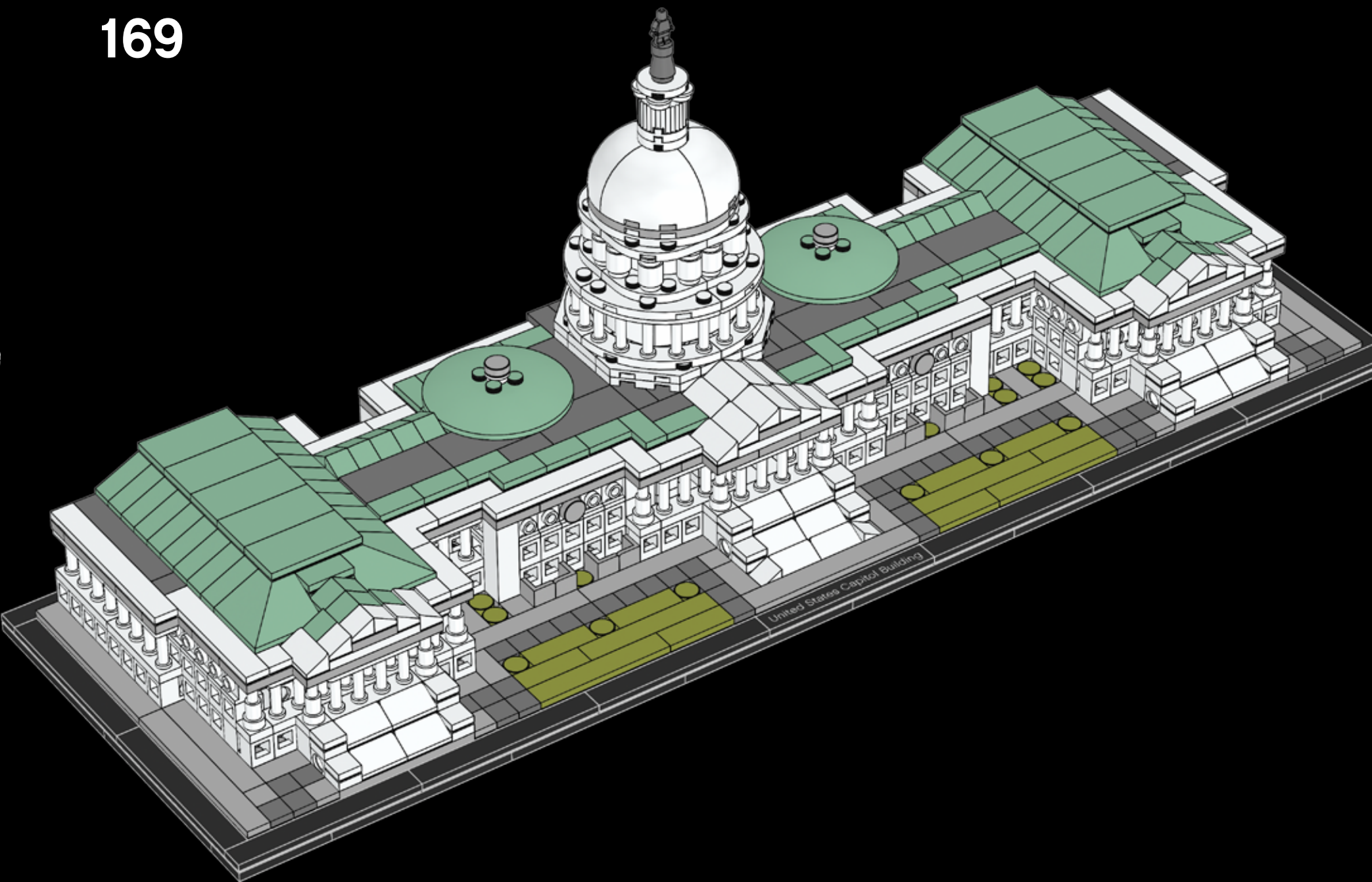

*[ One country, one Constitution, one destiny ]*

—Daniel Webster



## LEGO® Architecture—then and now

There has always been a natural connection between the LEGO® brick and the world of architecture. Fans who build with LEGO elements instinctively develop an interest in the form and function of the structures they create. At the same time, many architects have discovered that LEGO bricks are the perfect way of physically expressing their creative ideas.

This connection was confirmed in the early 1960s with the launch of the LEGO 'Scale Model' line. It matched the spirit of the age where modern architects were redefining how houses look and people were taking an active interest in the design of their new homes. These sets were designed to be different from the normal, brightly colored LEGO boxes; they also included a book on architecture as a source of inspiration.

Decades later, architect and LEGO fan Adam Reed Tucker, revived the idea of expressing architecture using LEGO bricks and in partnership with the LEGO Group, launched the LEGO Architecture line that we know today.

His first models, and the original sets in the current LEGO Architecture series, were interpretations of famous skyscrapers from his hometown of Chicago. Since then LEGO Architecture has developed and evolved, first with well-known buildings from other cities in the United States, and now with iconic structures from Europe, the Middle East and Asia.

The introduction of our LEGO Architecture Studio set echoes the ambitions of the earlier LEGO 'Scale Model' line and widens the potential of the LEGO Architecture series. Now you can enjoy building and learning about specific landmark buildings, or create exciting architectural models from your own fantasy. An inspiring 270-page book, featuring a number of renowned architects from around the world, guides you through the principles of architecture and encourages you in your own creative building.



21050  
Studio

Celebrate the world of architecture and collect all the models

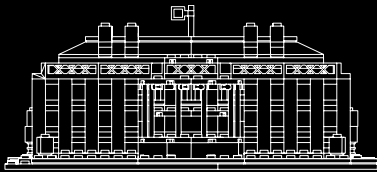

21006  
The White House

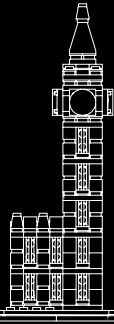

21013  
Big Ben

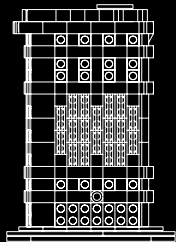

21023  
Flatiron Building



21024  
Louvre

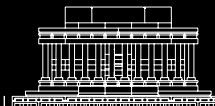

21022  
Lincoln Memorial

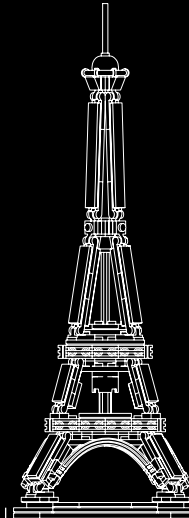

21019  
The Eiffel Tower



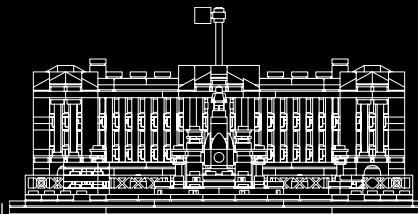

21029  
Buckingham Palace

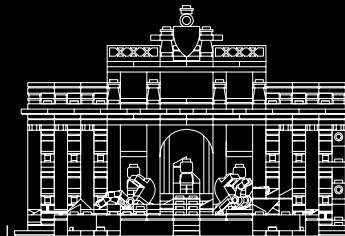

21020  
Trevi Fountain

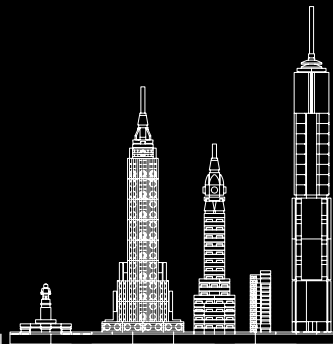

21028  
New York City



21027  
Berlin

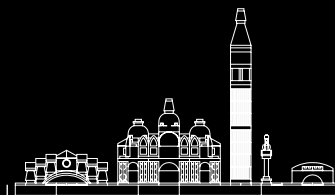

21026  
Venice

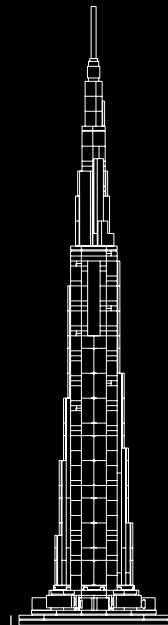

21031  
Burj Khalifa

# References

*Text credits:*

[www.visitthecapitol.gov](http://www.visitthecapitol.gov)

[www.aoc.gov](http://www.aoc.gov)

*Photography:*

[www.shutterstock.com](http://www.shutterstock.com)

Customer Service

Kundenservice

Service Consommateurs

Servicio Al Consumidor

[LEGO.com/service](http://LEGO.com/service) or dial

 00800 5346 5555 :

1-800-422-5346 : 



4x 6073432  
12x 306201  
18x 614101  
178x 407001  
10x 4504369  
2x 4558952  
28x 654101  
19x 307001  
26x 302401  
2x 6055541  
7x 403201  
28x 4547489  
1x 4650644  
1x 6093053  
18x 3200001  
18x 6051511  
22x 302301  
18x 306901

12x 6070327  
8x 6047220  
2x 6058329  
4x 235701  
3x 4520970  
8x 362301  
14x 362201  
6x 4558168  
15x 6047813  
3x 301001  
1x 4515347  
1x 4558956  
8x 245001  
4x 4586275

5x 302001  
4x 663601  
3x 300901  
4x 4215470  
4x 4178429  
1x 6109817  
3x 4181142  
4x 416201  
10x 300801  
8x 6146188  
2x 4159553  
12x 4125253  
4x 6092587

8x 4550745  
4x 473326  
3x 302026  
1x 6146728  
17x 416226  
22x 303426  
1x 4654448  
12x 6055172  
2x 4549436  
32x 4652205  
28x 4616578  
4x 4616581  
8x 4655080  
36x 4598531

4x 302224  
4x 4650260  
12x 4211415  
8x 4215513  
17x 4211398  
14x 4211414  
10x 4211353  
8x 4211429  
2x 4211396  
4x 4211445  
8x 4211395  
10x 4211438  
7x 4211549  
1x 6015349  
4x 4211452

15x 4211425  
5x 4211481  
2x 4211498  
3x 4251149  
4x 4211462  
4x 4211043  
4x 4211001  
2x 6039176  
8x 4560184  
1x 4529240  
46x 4210848  
10x 4211052  
2x 4211094  
5x 6146192

4x 4210651  
6x 4210794  
2x 4210802  
6x 4654613  
18x 6047015  
8x 6046903  
4x 6016484  
4x 4598532  
2x 6146199  
10x 4633693  
1x 303601

