



# Mixels

41577

# MYSTO



7 [LEGO.com](http://LEGO.com)

6163210

1

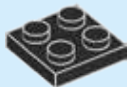

2



3

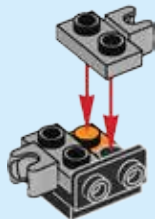

4



5

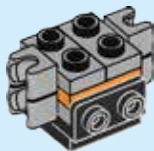

6

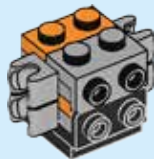

7

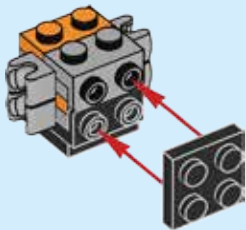

8



9

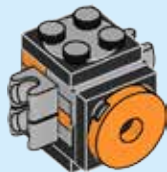
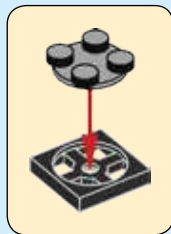



**10**

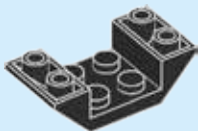

**11**

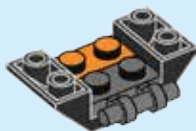

**12**

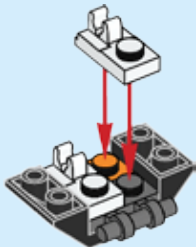

**13**

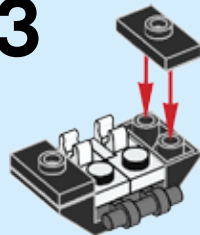

14

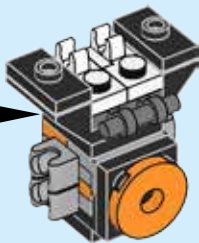

15

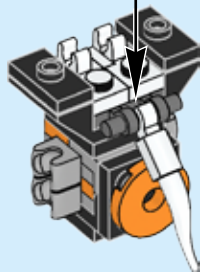
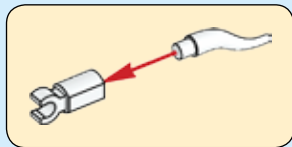



16

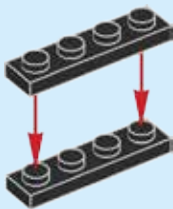

17



18





19

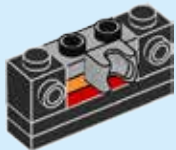

20

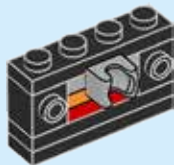

21

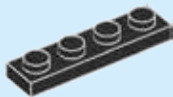

22



23

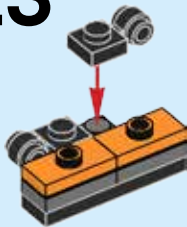

24



**25**



**26**

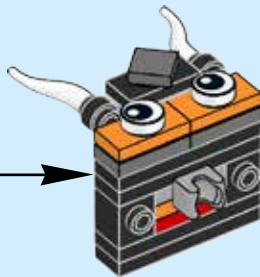

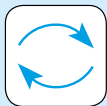

27

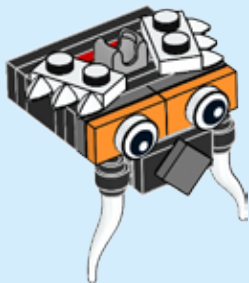

28

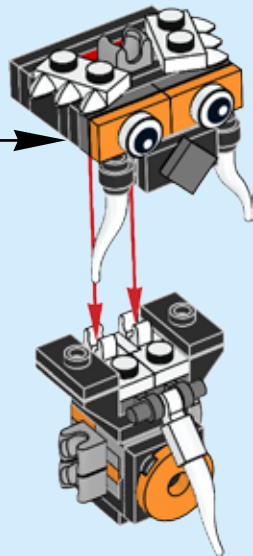



29

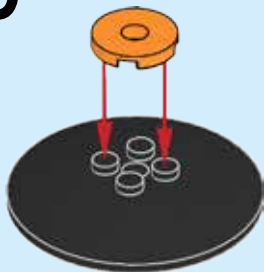

30

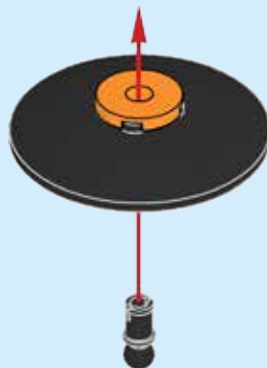

**31**

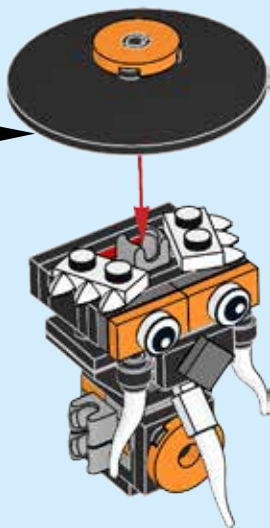



**32**

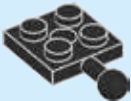

**33**



**34**



**35**



**36**



**2x**



37

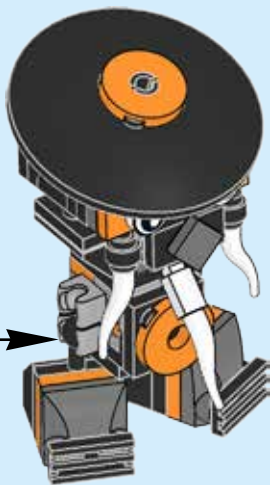

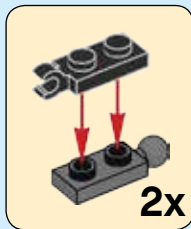

38

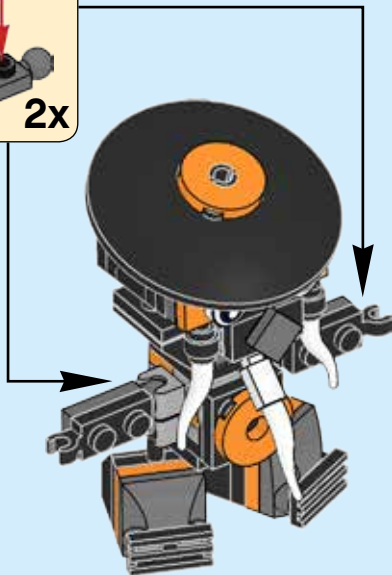

**39**

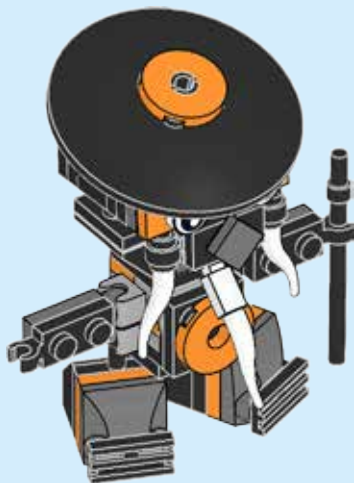



1x  
4540203



3x  
6032360



2x  
4632571



2x  
302226



4x  
371026



1x  
4210848



4x  
4177932



5x  
6043656



1x  
4226876



2x  
241226



1x  
368026



2x  
366026



1x  
4210660



2x  
6092599



2x  
4558954



3x  
6092585



2x  
4535739



1x  
4188534



2x  
6123814



1x  
6052824



1x  
4654582



1x  
4184169



1x  
6020193



2x  
6051038



1x  
6081988



2x  
4210635



2x  
6029156



1x  
6058341



3x  
4159007



2x  
4598527



2x  
4218696



2x  
6147052



2x  
6046381



**Customer Service**

**Kundenservice**

**Service Consommateurs**

**Servicio Al Consumidor**

**LEGO.com/service or dial**



**00800 5346 5555 :**



**1-800-422-5346 :**





**COBRAX  
41575**



**SPINZA  
41576**



**MYSTO  
41577**

**NINDJAS  
MAX!**



**LEGO.com/mixels**





# Mixels

SERIES  
9



**COBRAX**  
41575



**MYKE**  
41580



**CAMSTA**  
41579



**MYSTO**  
41577



**SWEEPZ**  
41573



**SCREENO**  
41578



**SPINZA**  
41576



**COMPAX**  
41574



**GOBBOL**  
41572



# CALLING ALL Mixels

# Mixels RUSH



**PLAY FOR FREE!**



**PLAY FOR FREE!**

Download on the  
 App Store

ANDROID APP ON  
 Google play

Apple, the Apple logo, iPad, iPhone and iPod touch are trademarks of Apple Inc. Google Play is a trademark of Google Inc.