



MARVEL STUDIOS

SPIDER-MAN

No Way Home

76184

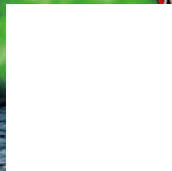



Check for compatibility
Kompatibilität prüfen
Vérifier la compatibilité
Controlla la compatibilità
Comprueba tu compatibilidad
Verificar a compatibilidade
Ellenőrizd a kompatibilitást
Pārbaudīt saderību
检查兼容性

[LEGO.com/devicecheck](https://www.lego.com/devicecheck)

乐高® 拼搭指引



LEGO® Building Instructions



Download on the
App Store



GET IT ON
Google Play



腾讯应用宝
安卓应用商店

Apple and the Apple logo are trademarks of Apple Inc.
Google Play and the Google Play logo are trademarks of Google LLC.
Tencent and the Tencent logo are trademarks of Tencent Inc.





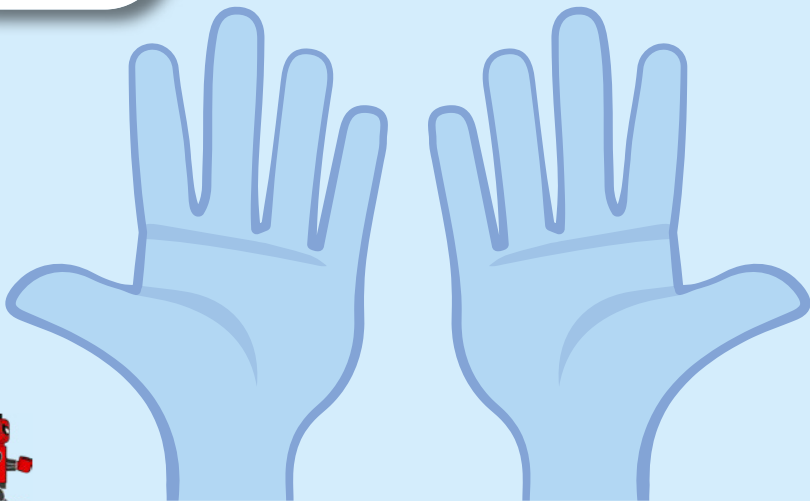

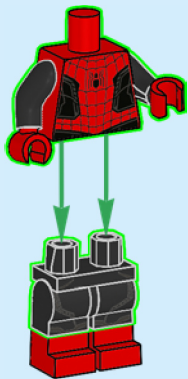

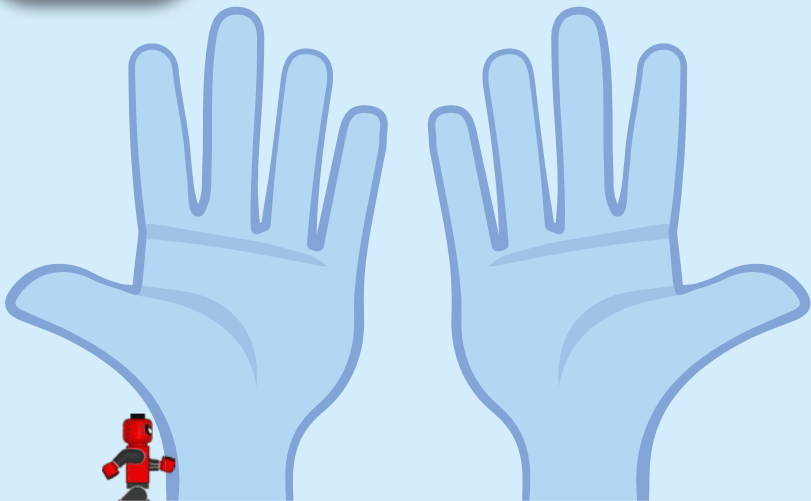
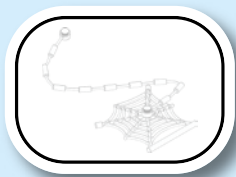



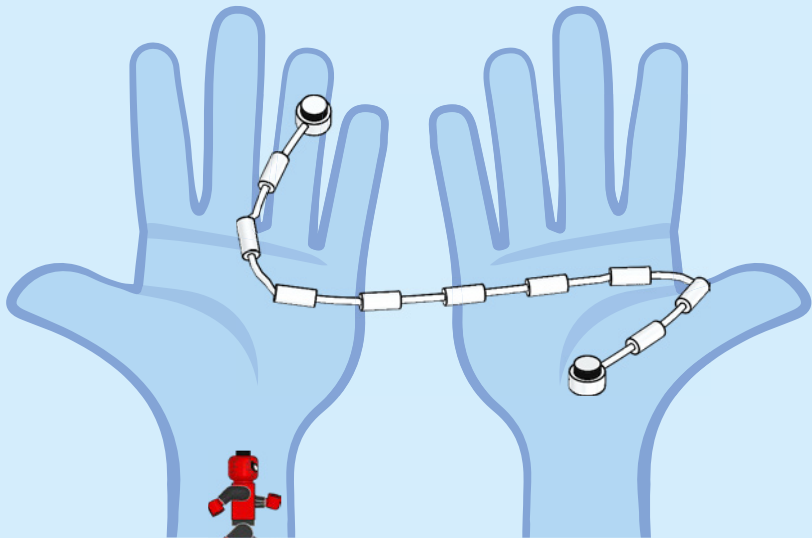

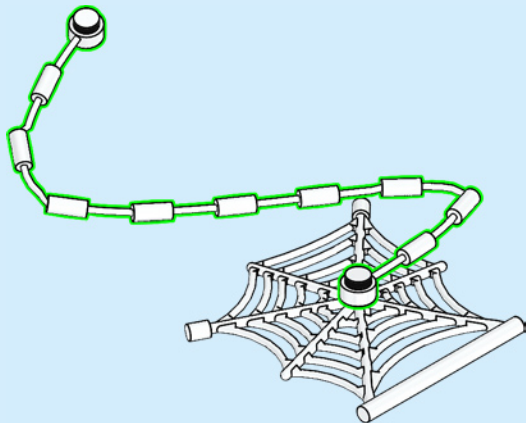

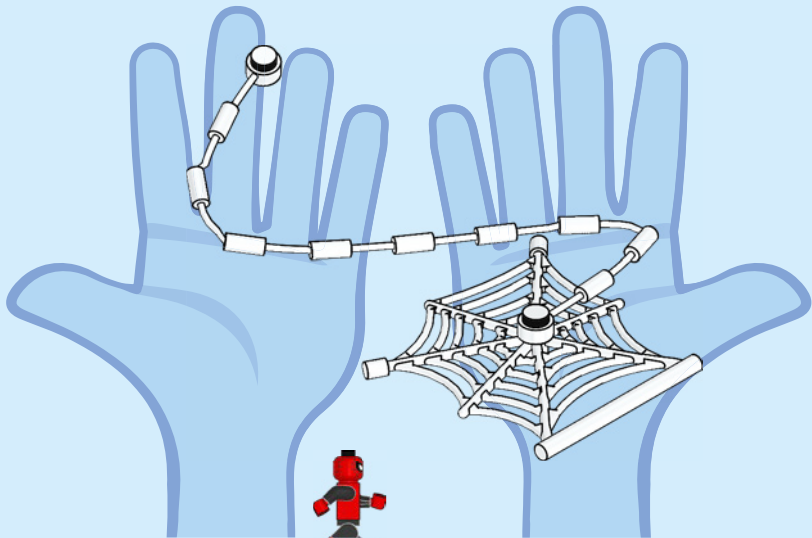

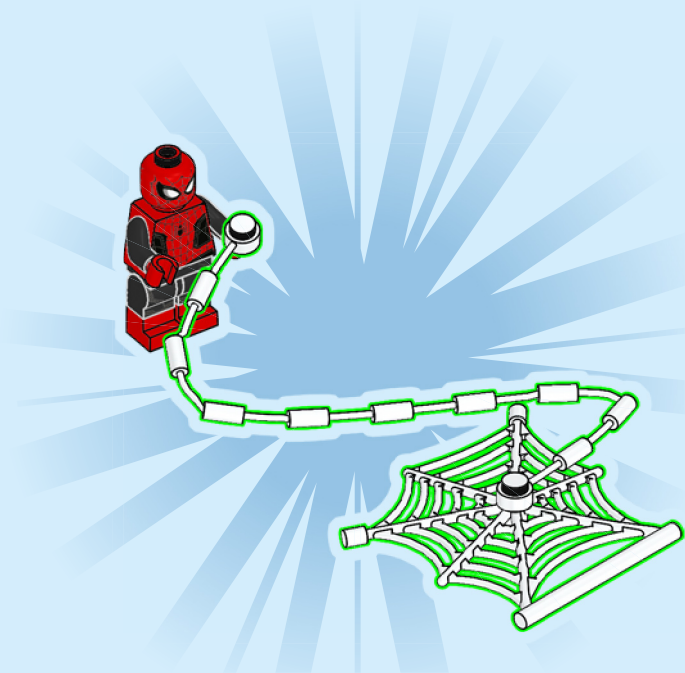

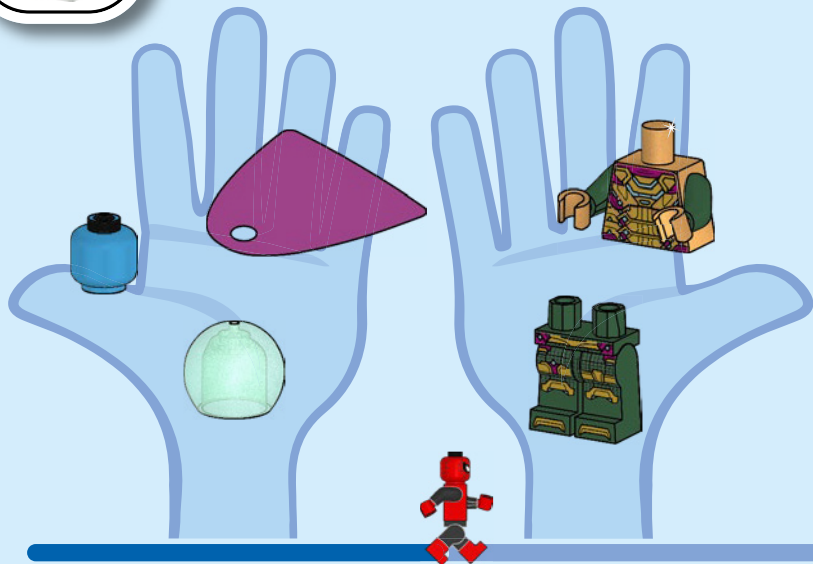

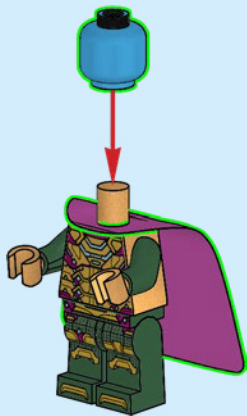
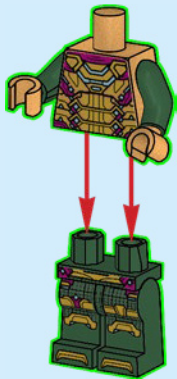

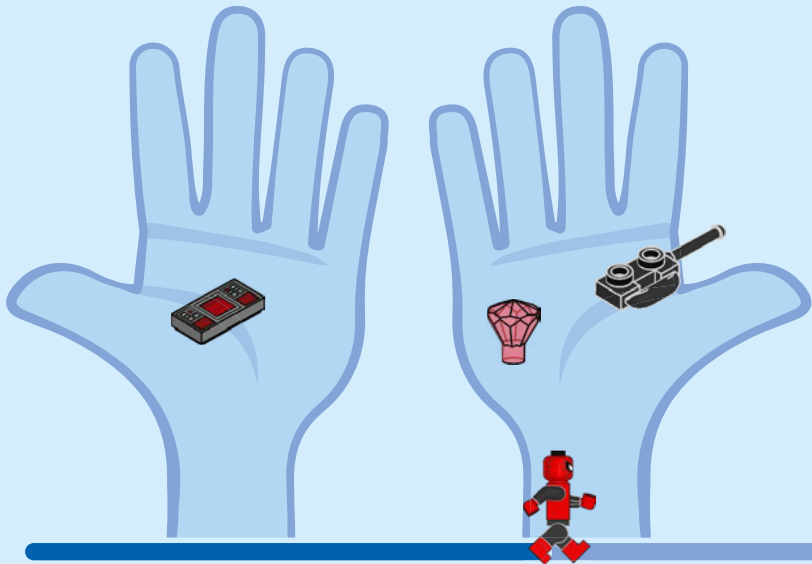

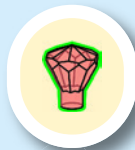
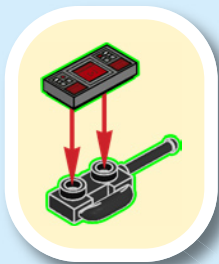

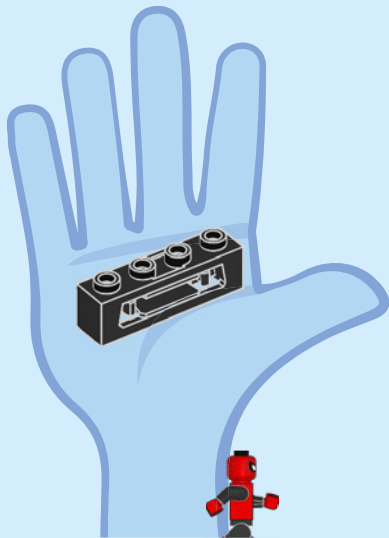
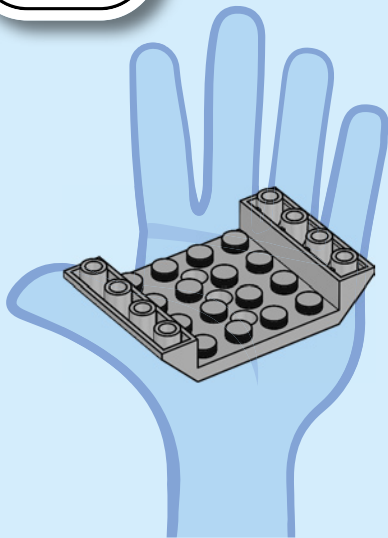
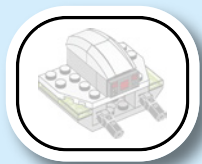

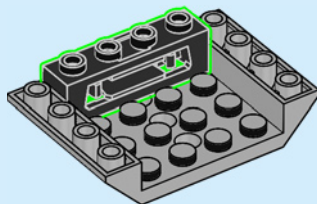
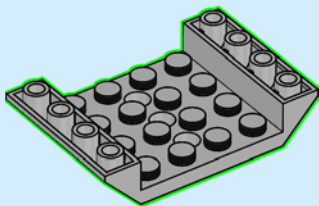

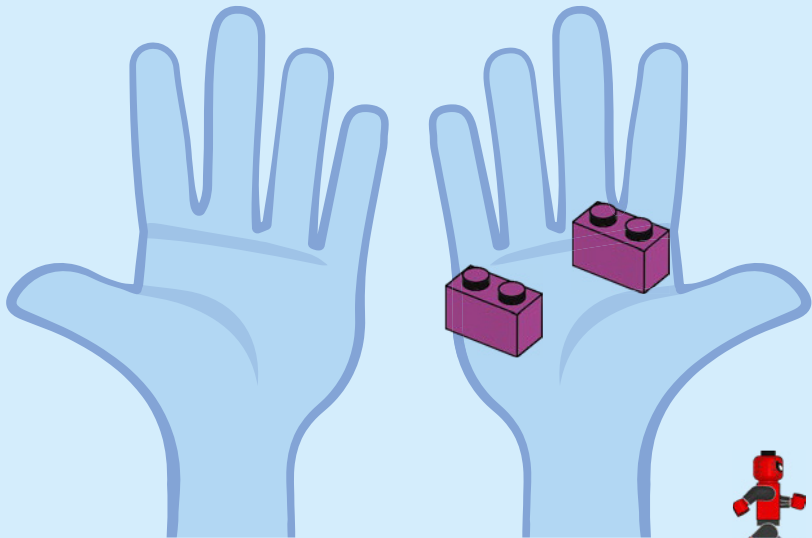

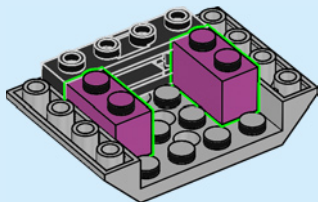

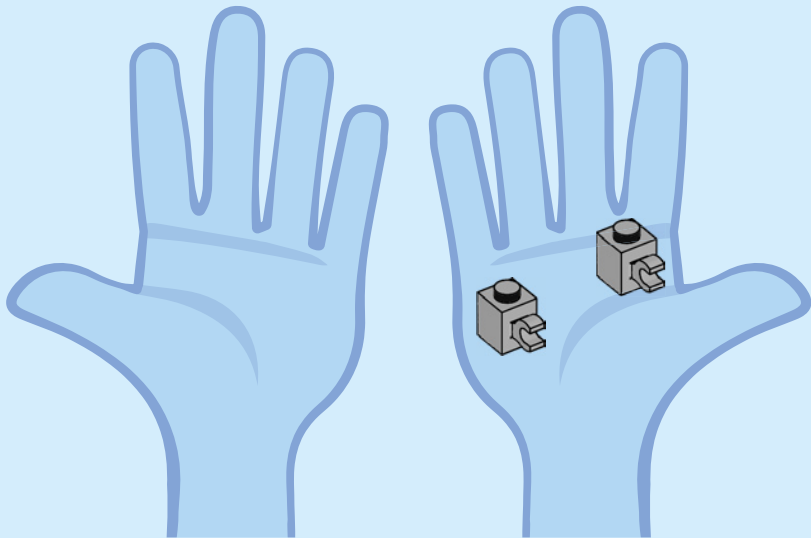

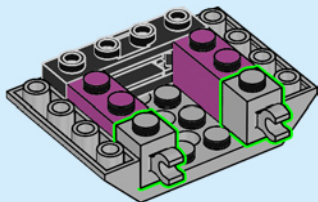

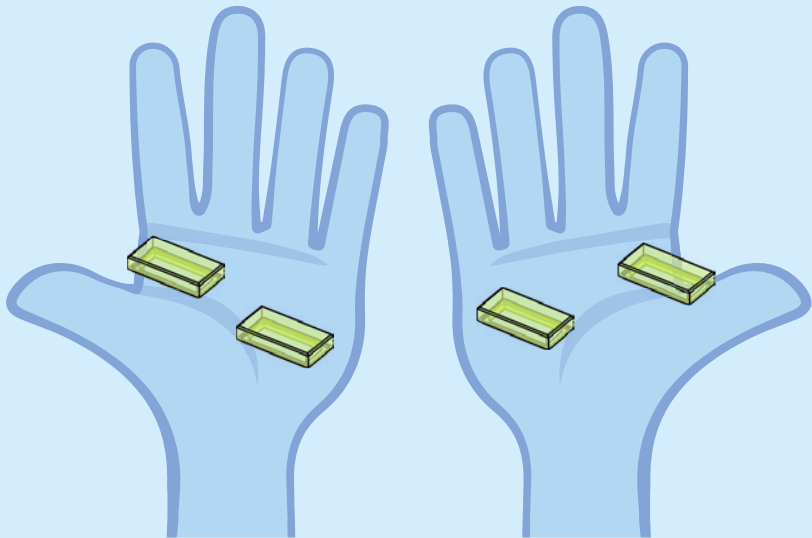

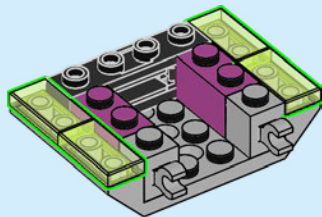

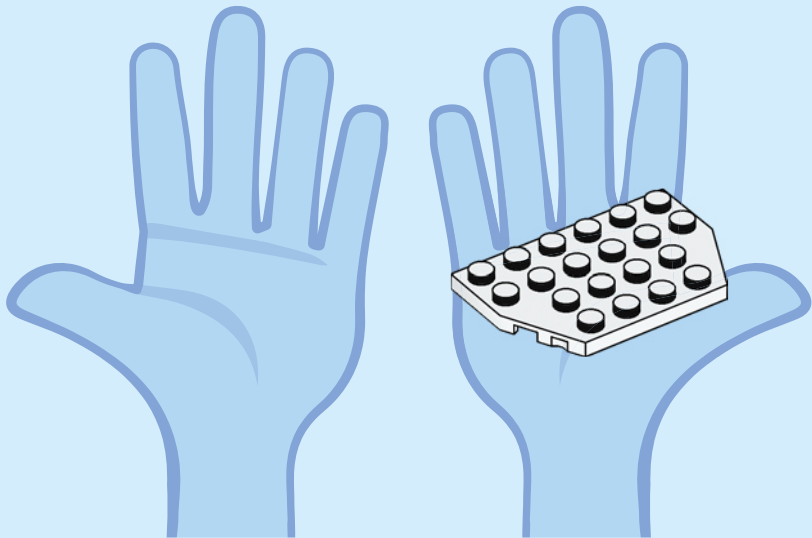

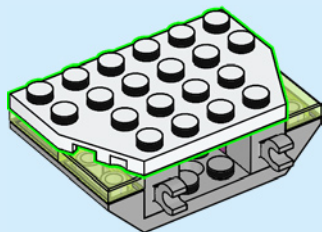

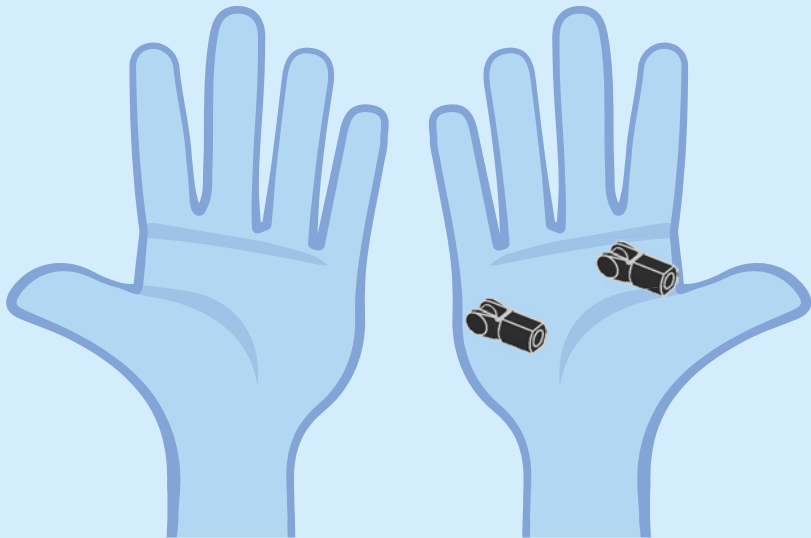

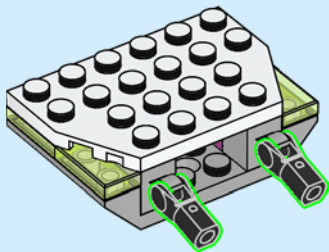

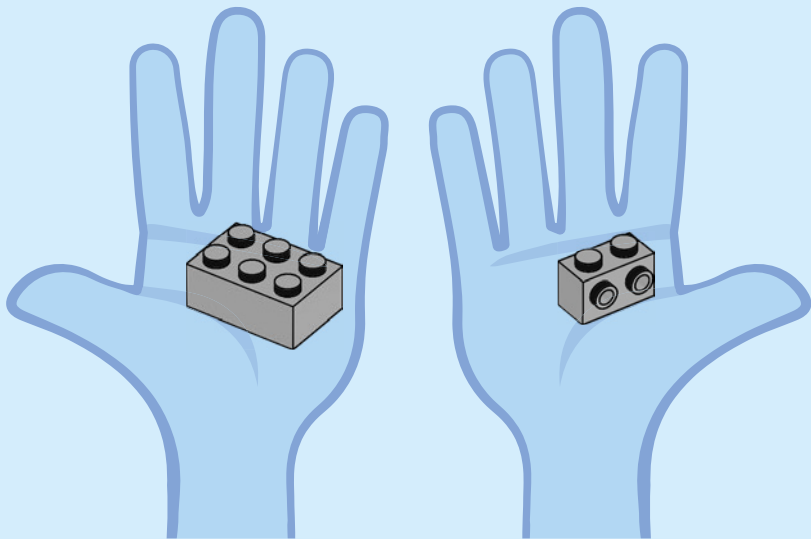

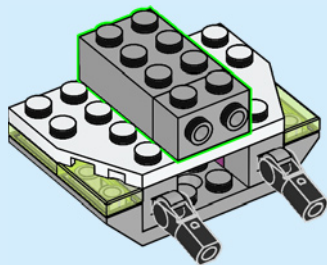

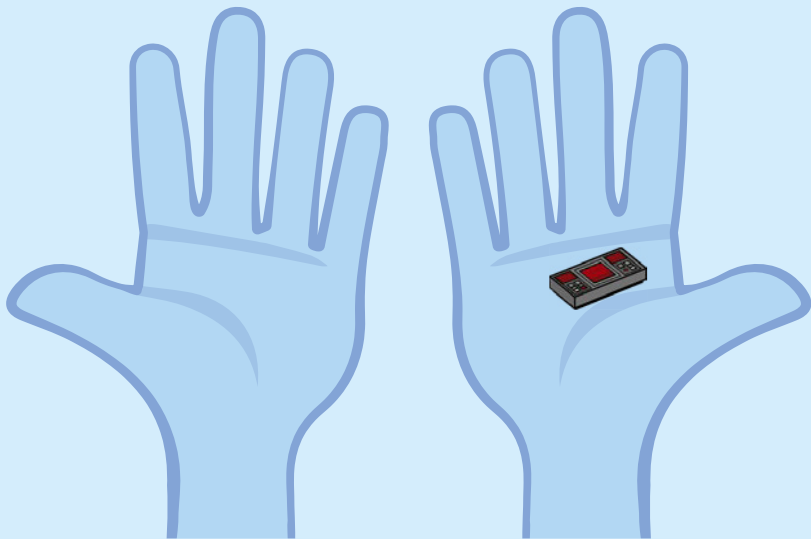

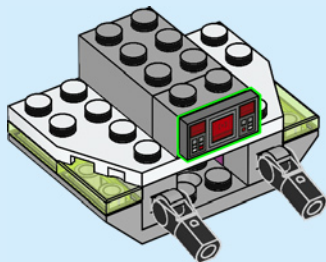
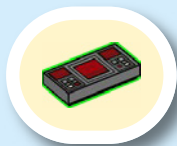

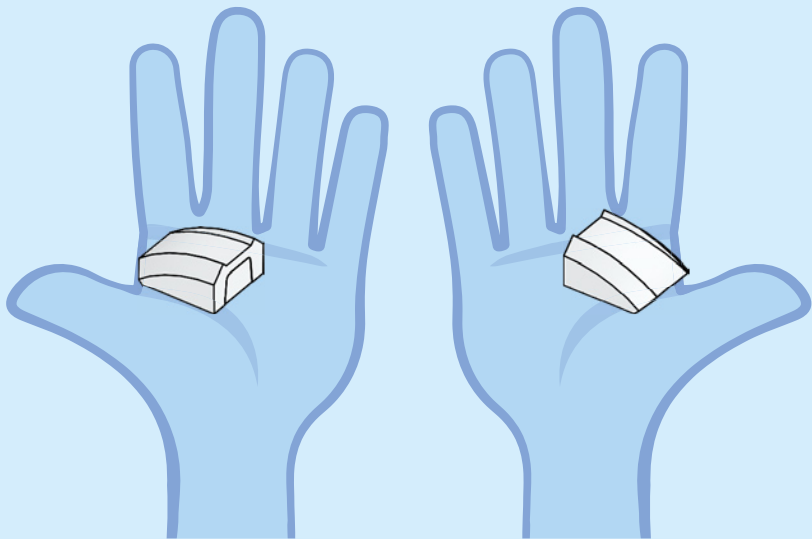

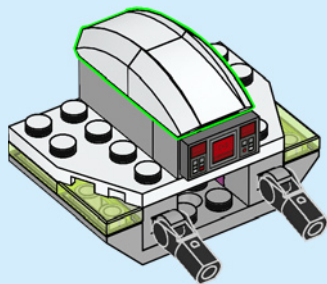

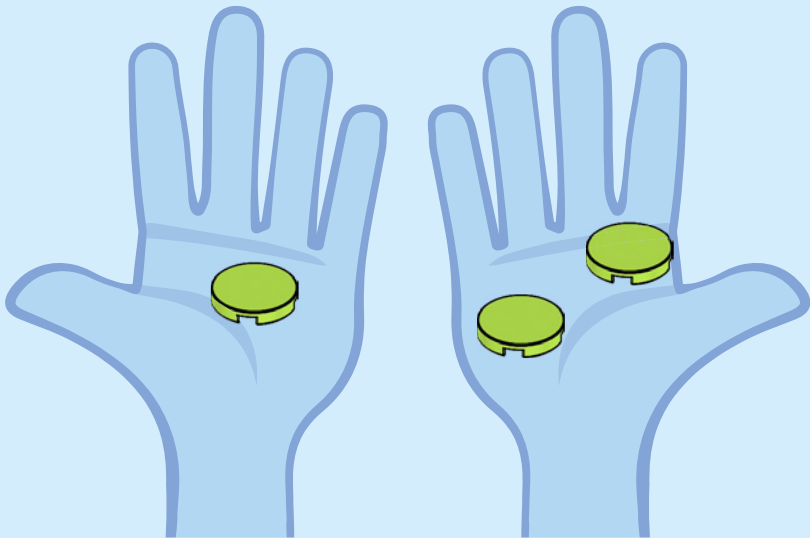

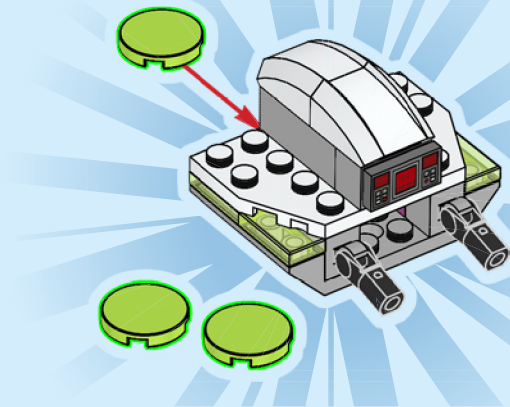

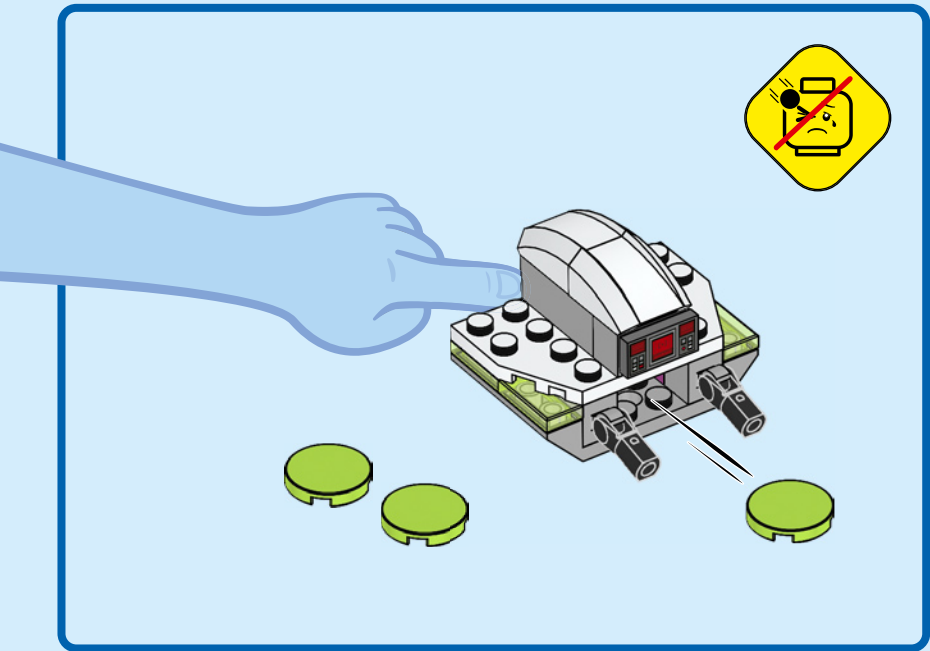

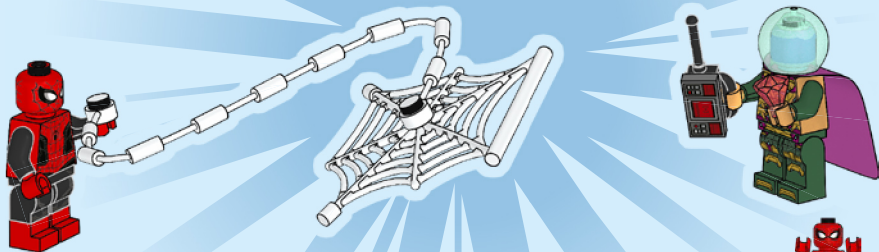

WIN

GO TO WWW.LEGO.COM/PRODUCTFEEDBACK AND
GIVE US YOUR SHORT **FEEDBACK** ABOUT THIS
LEGO® SET FOR A CHANCE TO WIN
A COOL LEGO PRIZE.

Terms & Conditions apply

LEGO.com/productfeedback



GEWINNE

Erzähle uns auf
www.LEGO.com/productfeedback

etwas über die Erfahrungen, die du
mit diesem LEGO® Set gemacht hast,
und sichere dir die Chance auf einen
coolen LEGO Preis!

Es gelten die Teilnahmebedingungen

GAGNE

Rends-toi sur
www.LEGO.com/productfeedback

et donne-nous quelques commen-
taires sur ce produit LEGO® pour
avoir une chance de gagner un
prix LEGO !

Voir Conditions Générales

GANAN

Visita
www.LEGO.com/productfeedback

y envíanos tu opinión acerca de este
set LEGO®. ¡Participarás en el sorteo
de un premio LEGO!

Términos y Condiciones aplicables

获取奖品

登录
www.LEGO.com/productfeedback

给出关于此乐高®套装的简短反
馈，就有机会获得炫酷乐高奖品

《条款及条件》适用

LEGO and the LEGO logo are trademarks of the LEGO Group. ©2021 The LEGO Group.

© Marvel © CPII

6390631



MARVEL STUDIOS

SPIDER-MAN

No Way Home

76184





Check for compatibility
Kompatibilität prüfen
Vérifier la compatibilité
Controlla la compatibilità
Comprueba tu compatibilidad
Verificar a compatibilidade
Ellenőrizd a kompatibilitást
Pārbaudīt saderību
检查兼容性

[LEGO.com/devicecheck](https://www.lego.com/devicecheck)

乐高® 拼搭指引



LEGO® Building Instructions



Download on the
App Store



GET IT ON
Google Play



腾讯应用宝
安卓应用商店

Apple and the Apple logo are trademarks of Apple Inc.
Google Play and the Google Play logo are trademarks of Google LLC.
Tencent and the Tencent logo are trademarks of Tencent Inc.



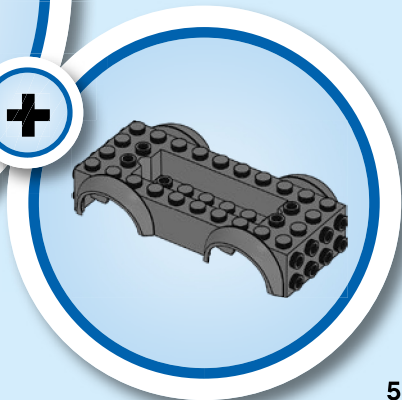

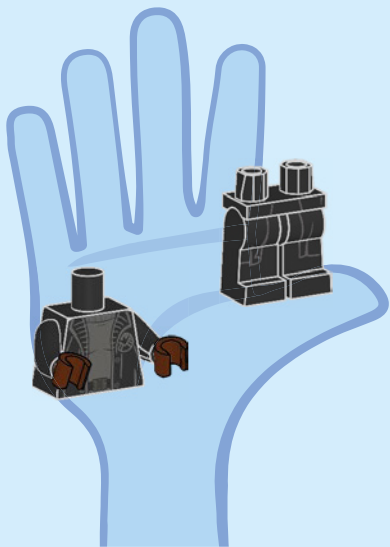

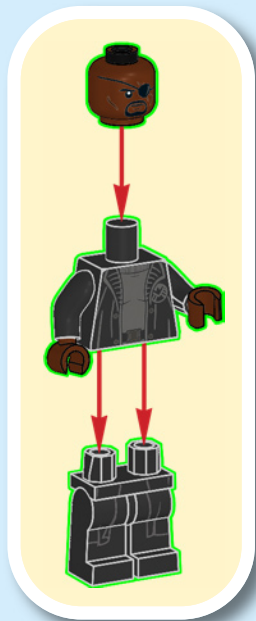

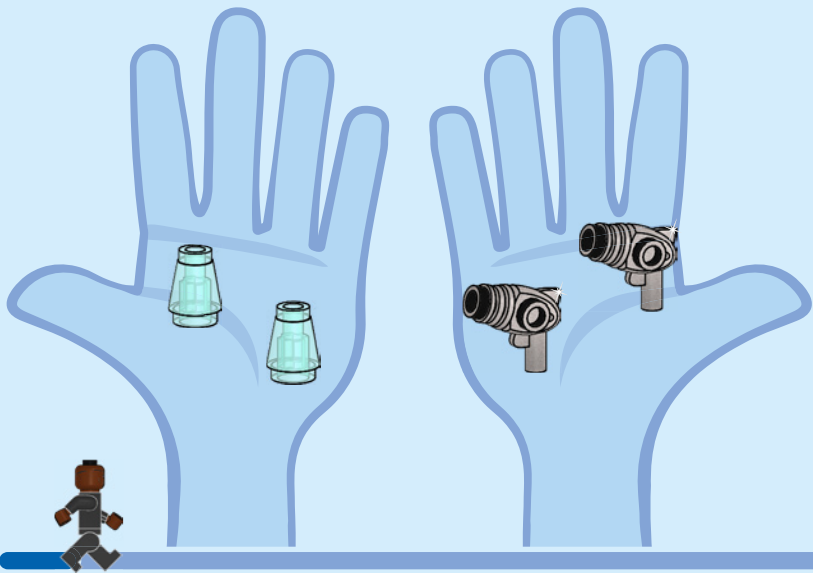



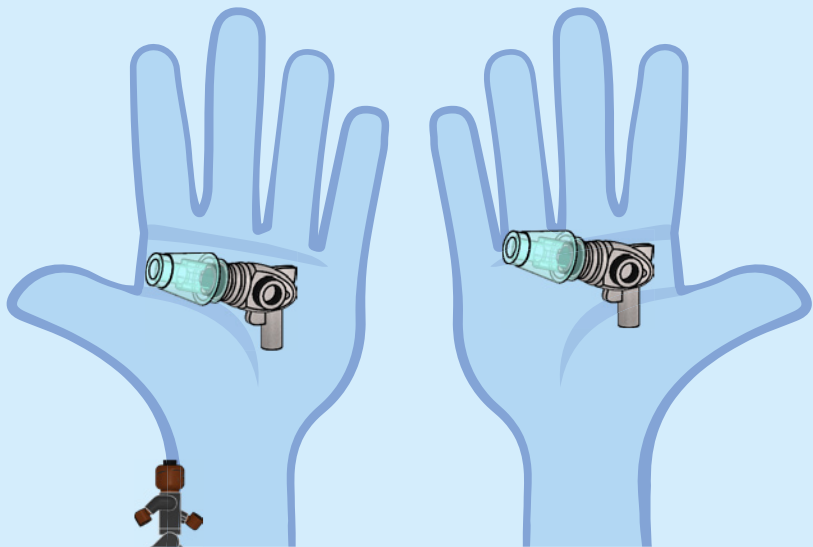



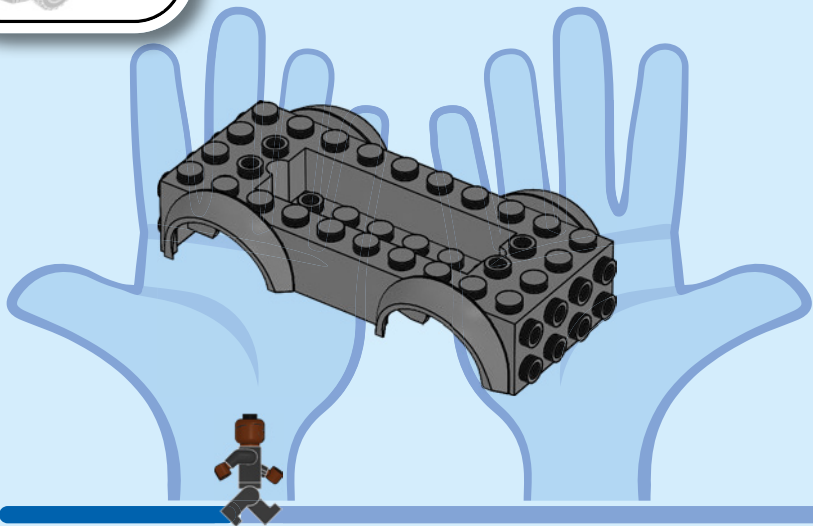

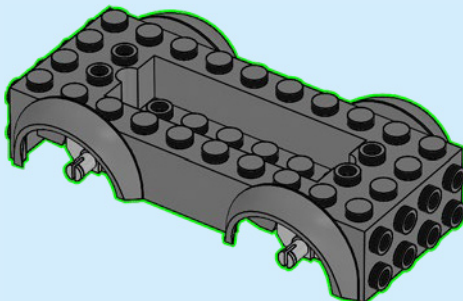



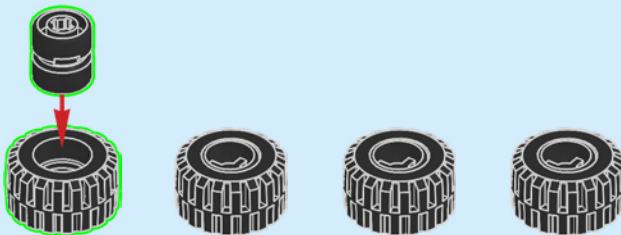

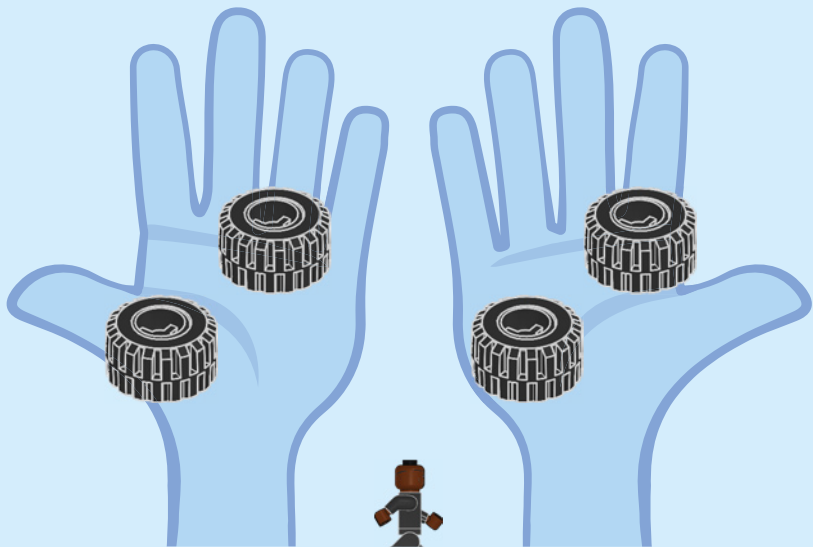

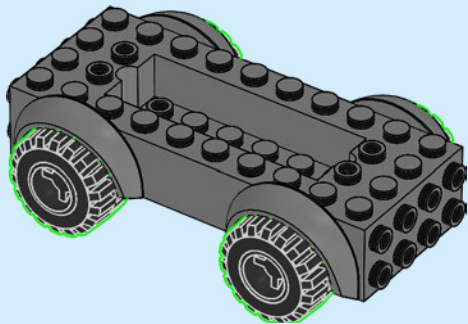

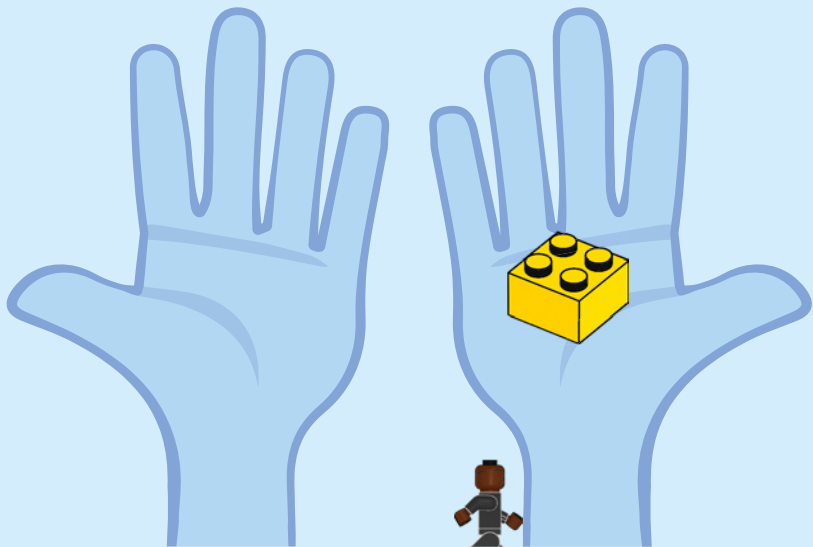

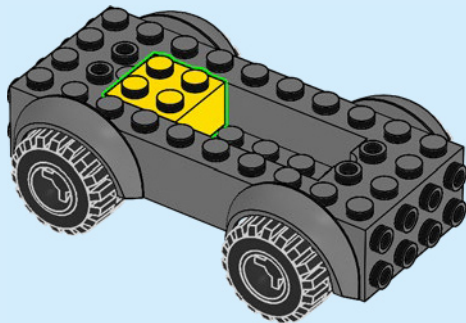

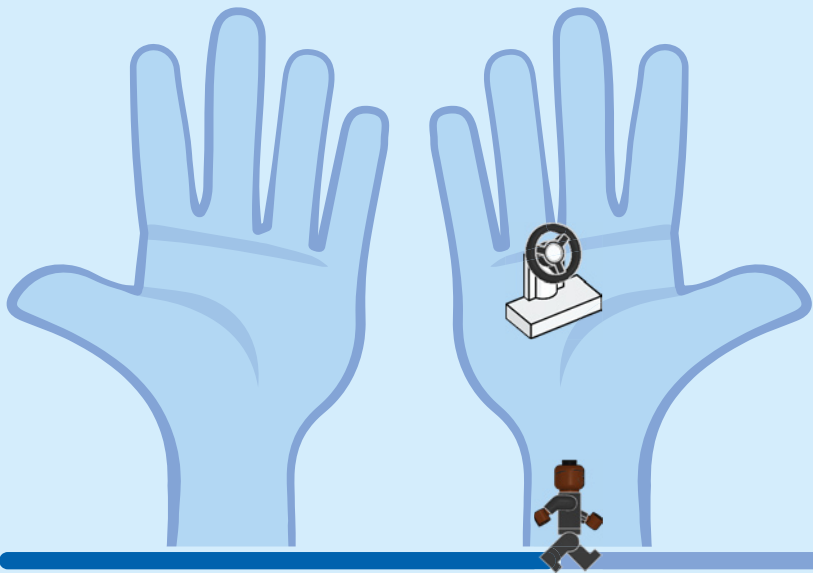

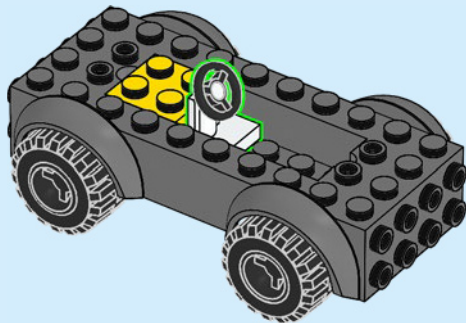



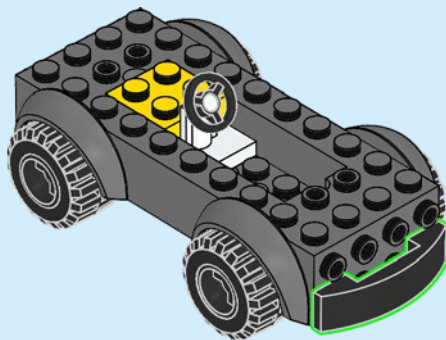

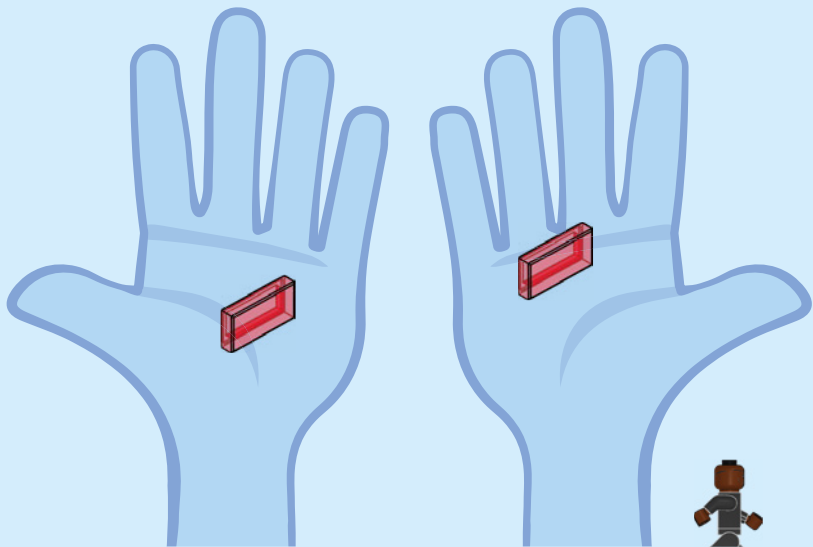

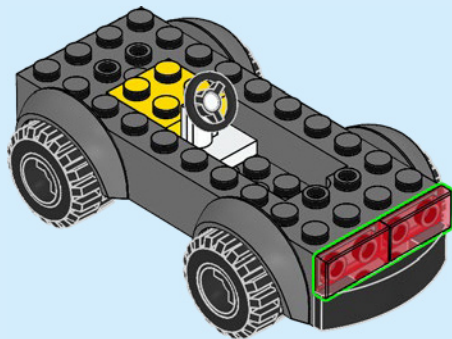



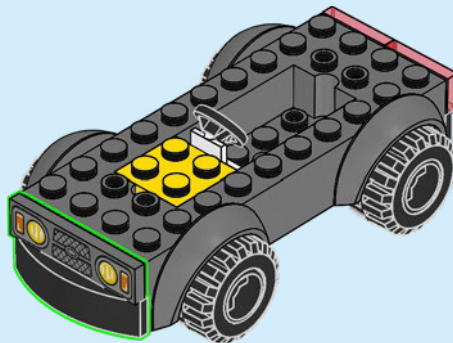

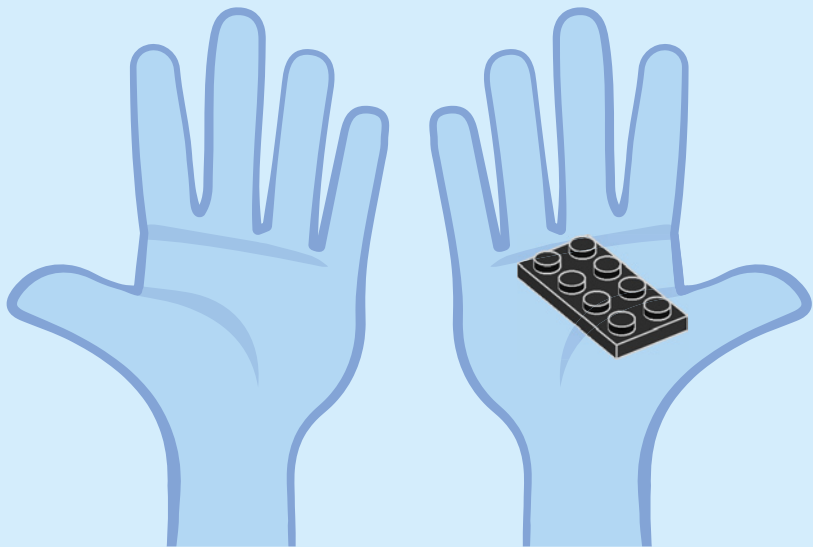

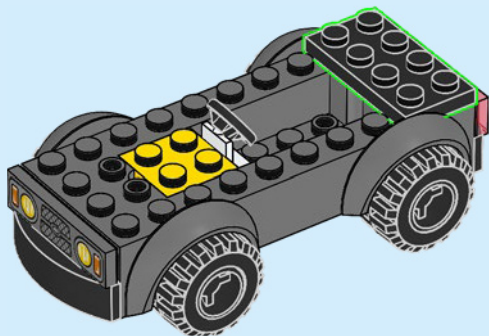

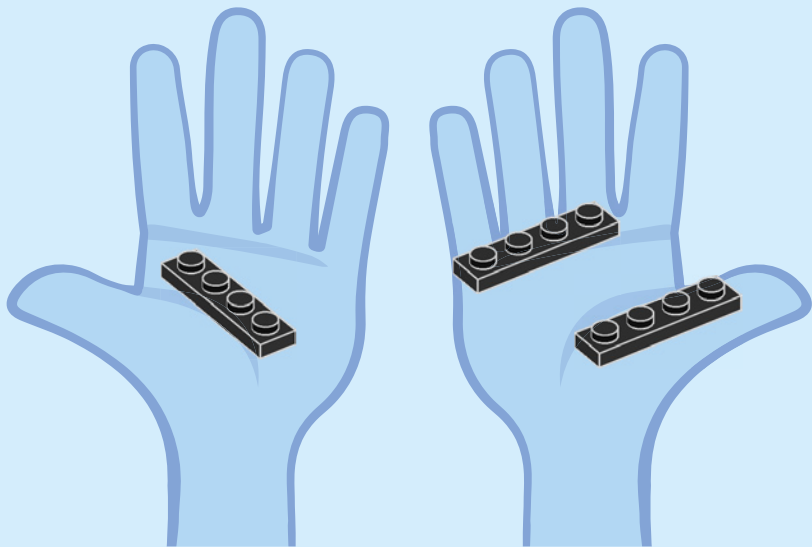

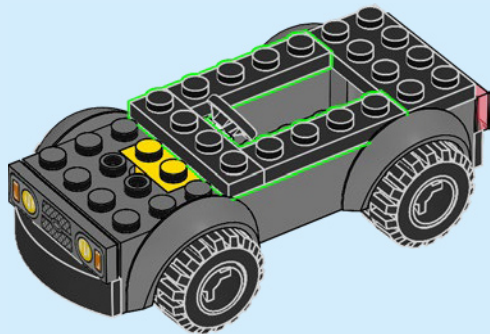

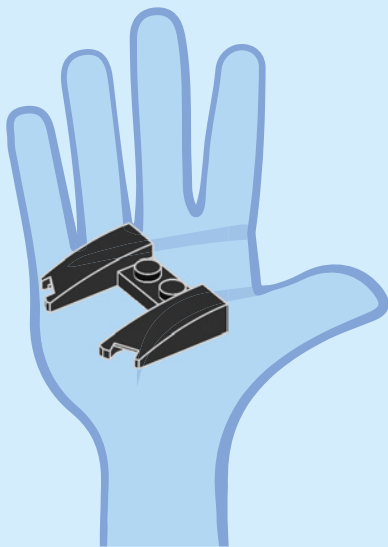
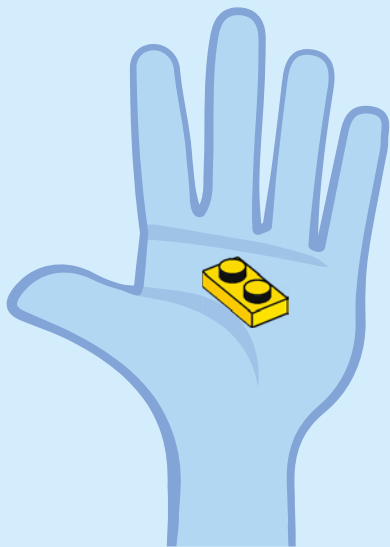

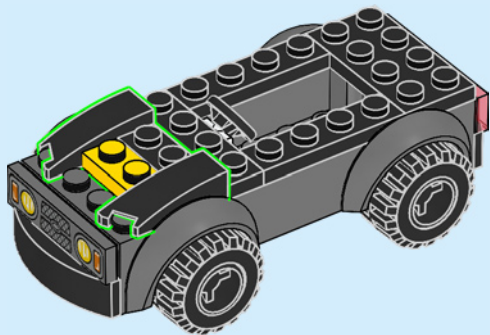

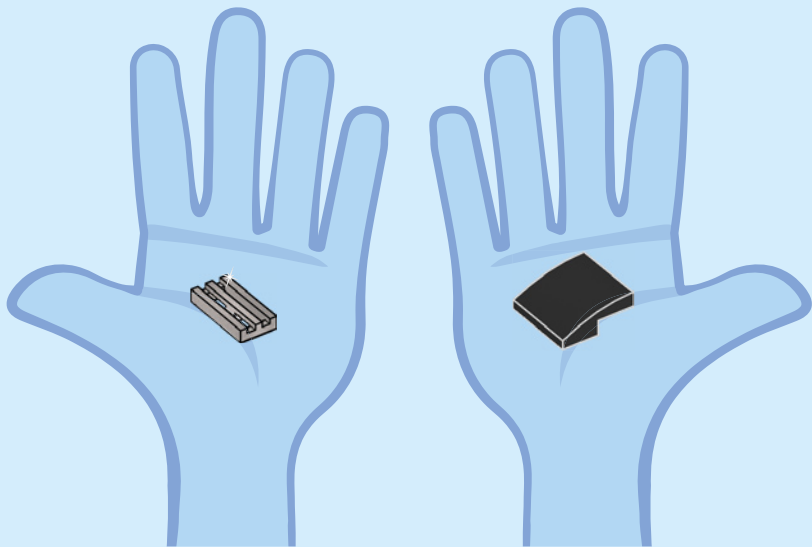

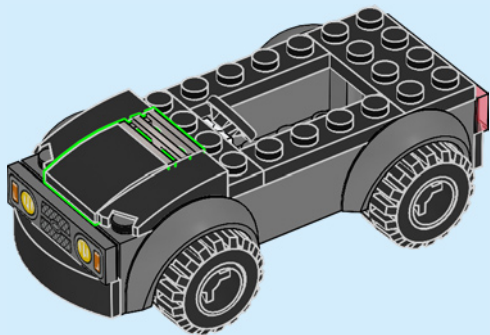

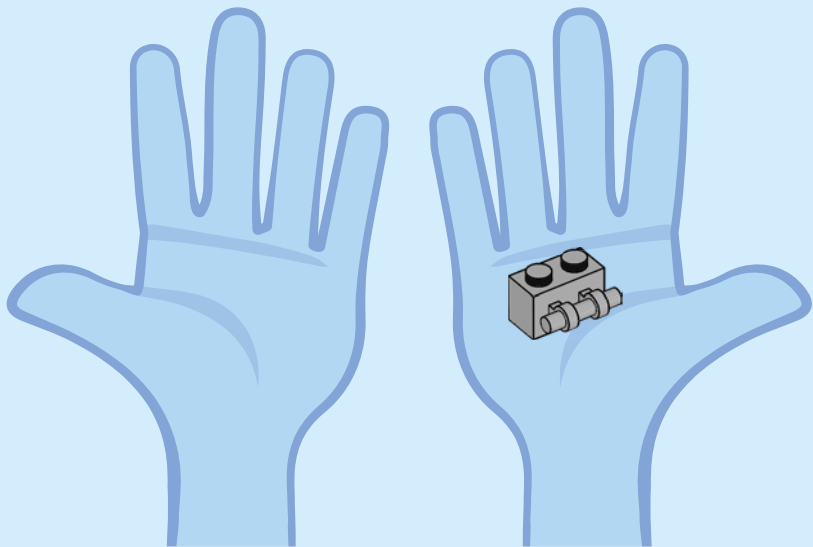

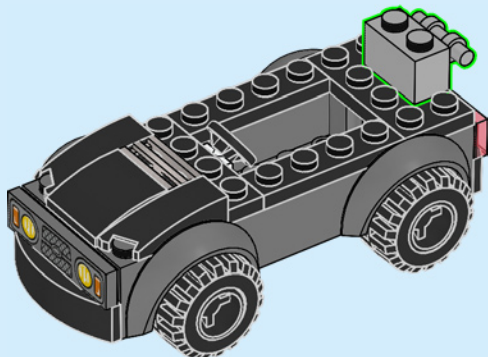

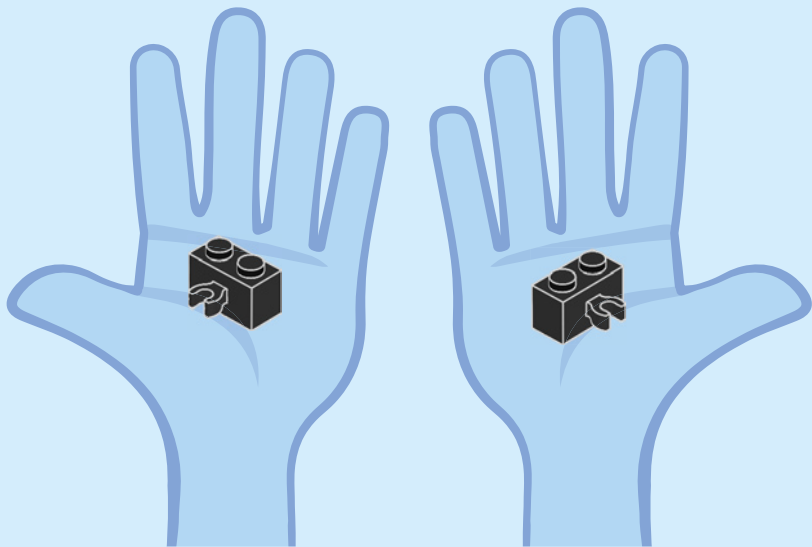

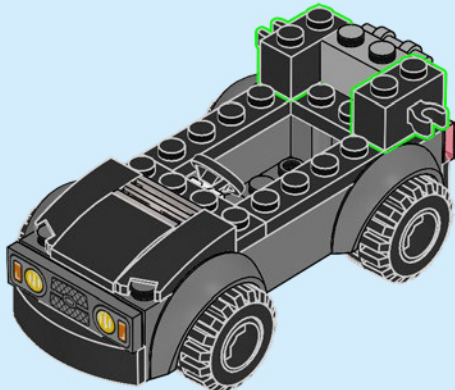

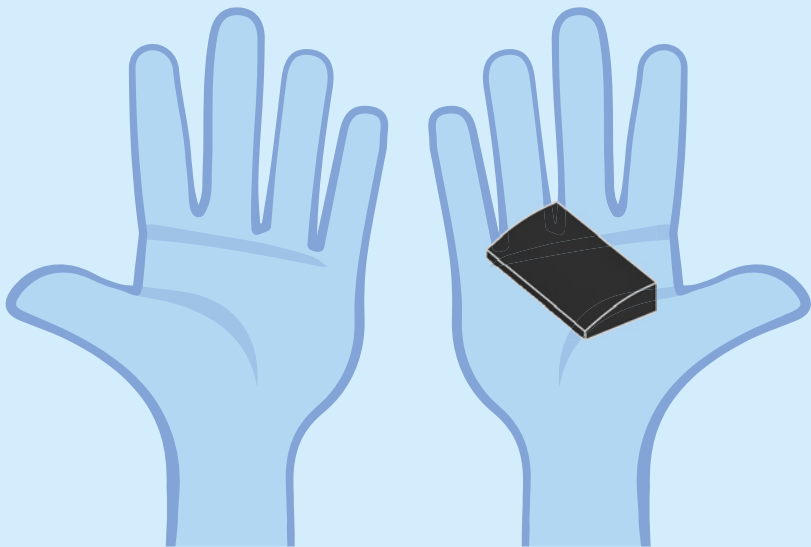

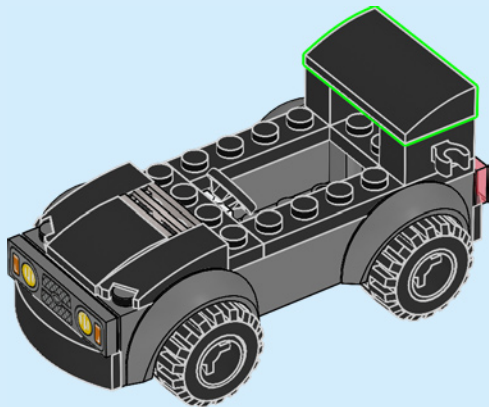

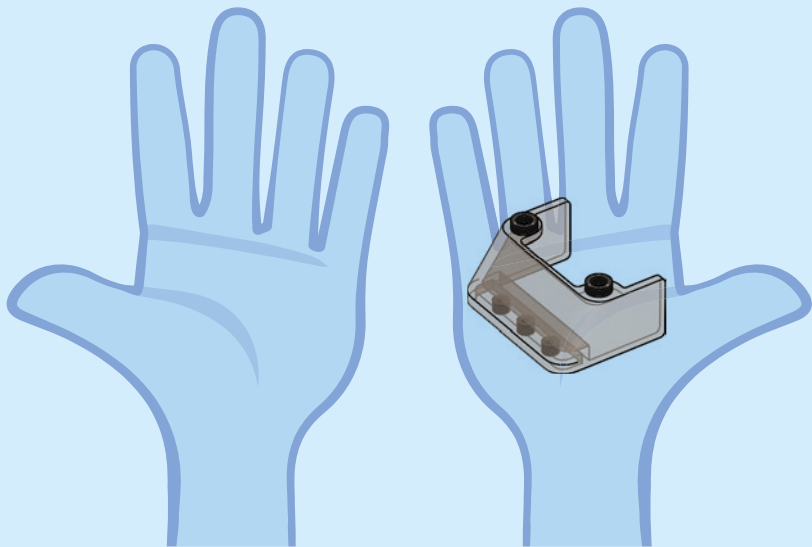

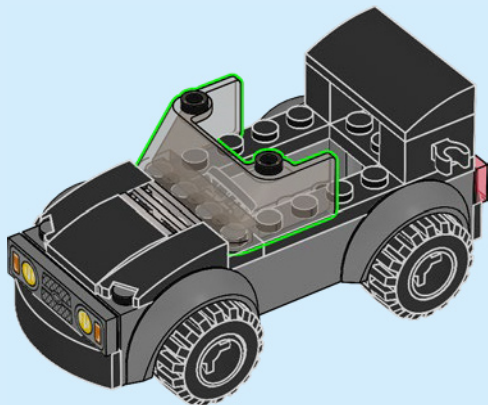

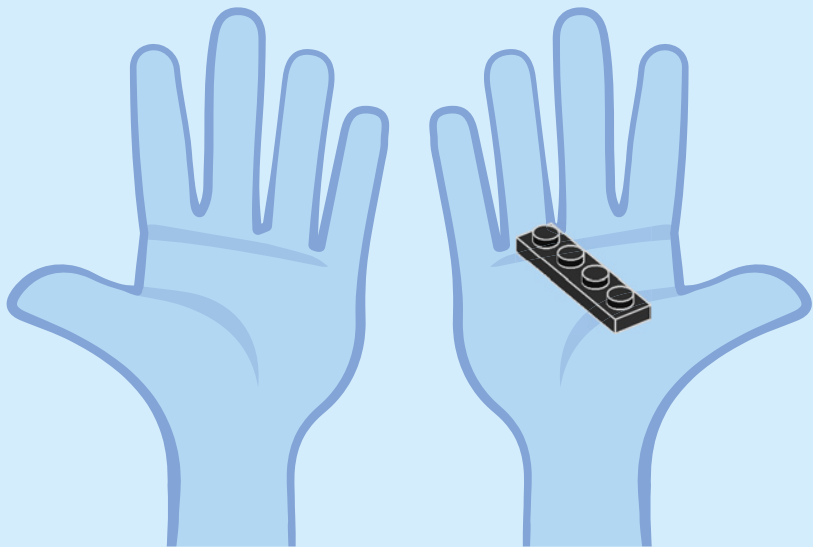

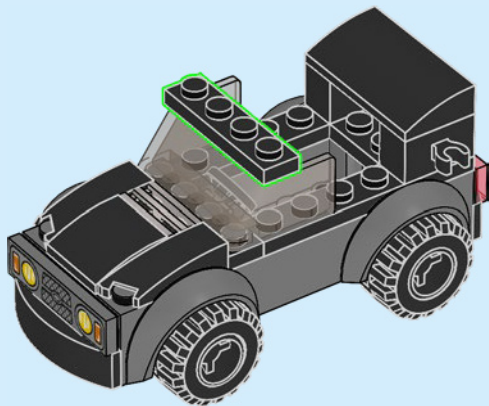

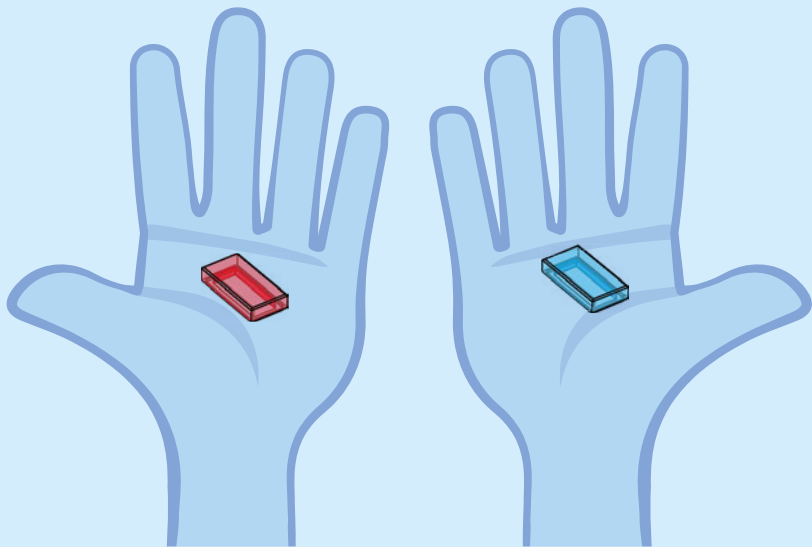

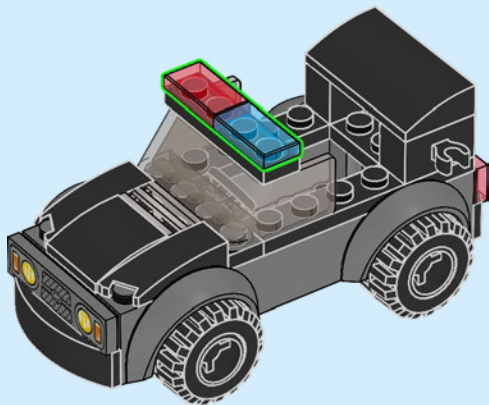

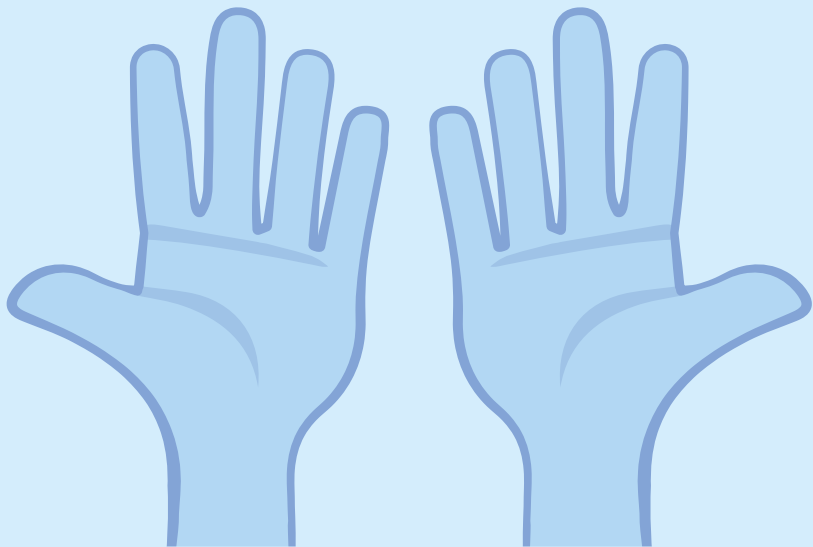

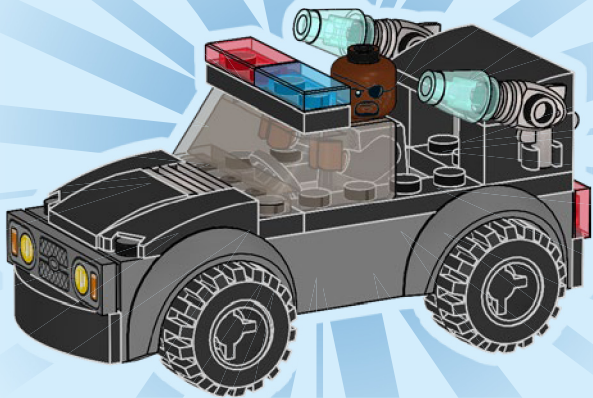



1x
9551



2x
4195869



1x
4508408



1x
6006221



1x
6096959

50



1x
6349786



1x
6368665



1x
302324



1x
300324



2x
6321194



1x
6170545



4x
6286850



1x
6363243



1x
6308975



2x
6330197



4x
4568644



1x
6053077



2x
4613153



1x
6356162



4x
371026



1x
4587844



1x
302026



1x
6179660



1x
6267014



1x
6253360



3x
6092766



2x
4519195



1x
6294957



1x
6363240



1x
6267012



2x
6320306



1x
6015344



1x
4211580



1x
4211386

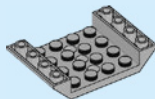

1x
4549997



1x
6251289



1x
6247785



3x
6251290



2x
6337639



1x
6368666



4x
6251298



2x
6046398



1x
4619636



1x
6151415



1x
6324167

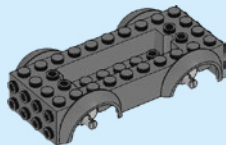

1x
6250176



2x
6291791



1x
6223079



Customer Service
Kundenservice
Service Consommateurs
Servicio Al Consumidor

LEGO.com/service or dial



: 00800 5346 5555

: 1-800-422-5346



LEGO and the LEGO logo are trademarks of the LEGO Group. ©2021 The LEGO Group.

© Marvel © CPII

Rebuild
the
world™



6390633