



# DOTS™

41961



# CREATE YOUR OWN DESIGNS

CREATE YOUR OWN DESIGNS  
GESTALTE EIGENE DESIGNS  
CRÉE TES PROPRES MOTIFS  
CREA I TUOI DESIGN  
CREA TUS PROPIOS DISEÑOS  
CRIA OS TEUS PRÓPRIOS DESIGNS  
KÉSZÍTSD EL A SAJÁT ÍZLÉSED SZERINT  
VEIDO PĀTS SAVUS DIZAINUS  
CREEAZĂ PROPRIILE TALE MODELE  
创造属于自己的设计

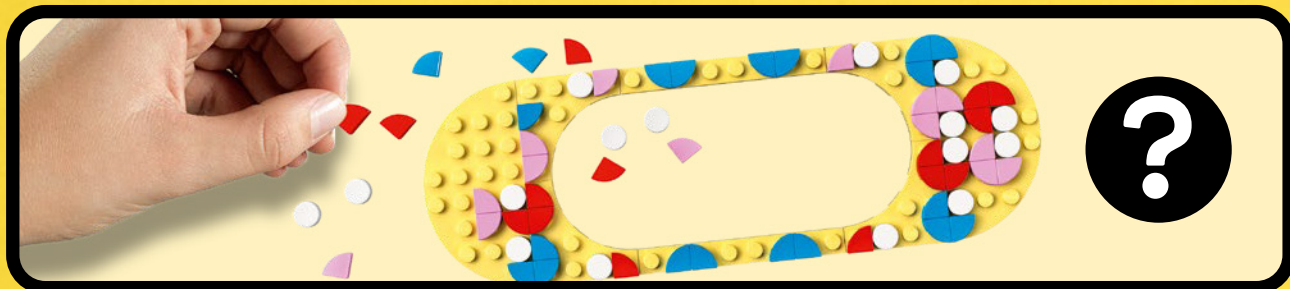
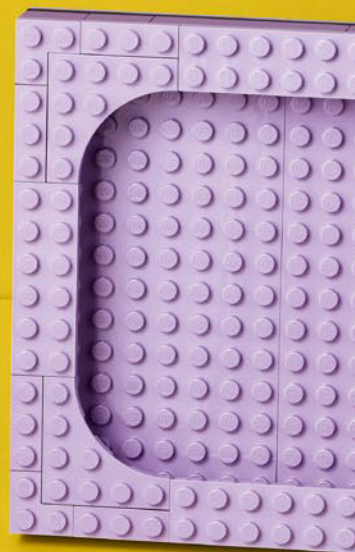
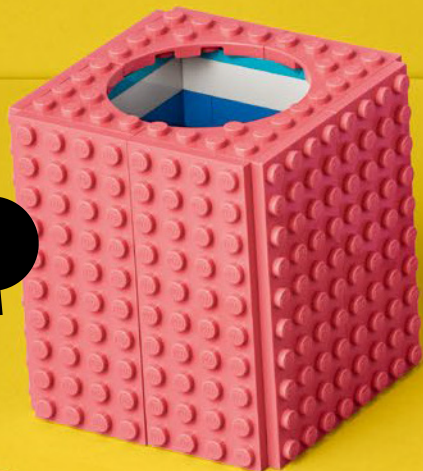

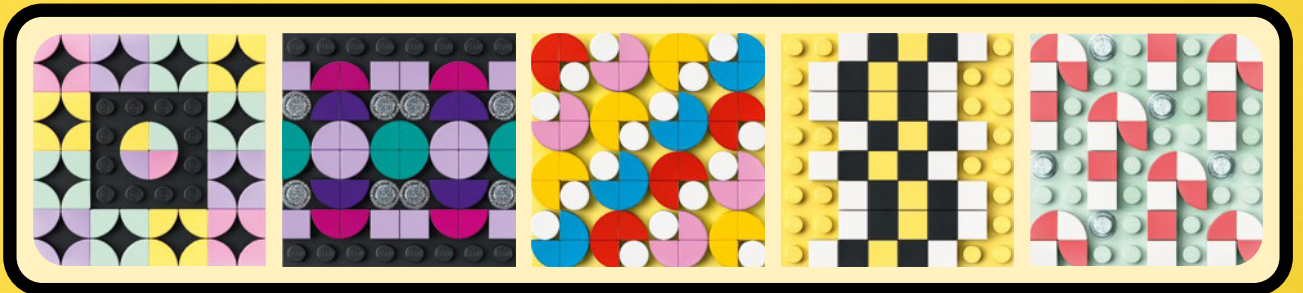

# LEGO DOTS

**STYLE IT  
YOUR WAY**

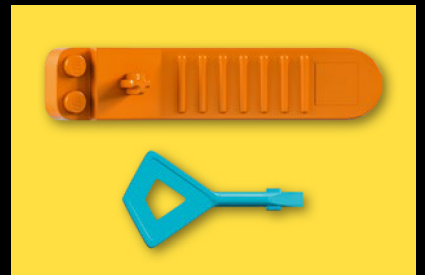
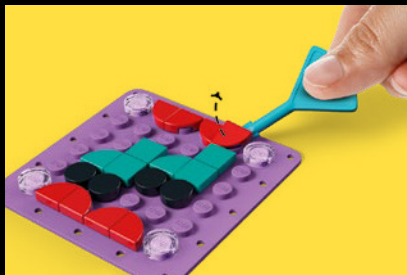
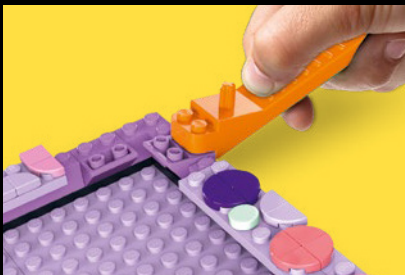
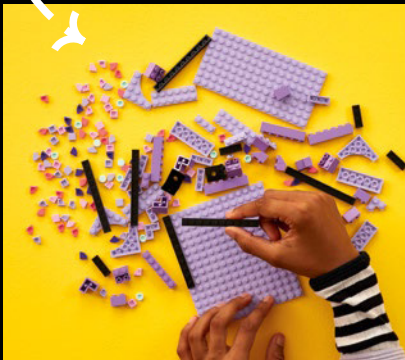
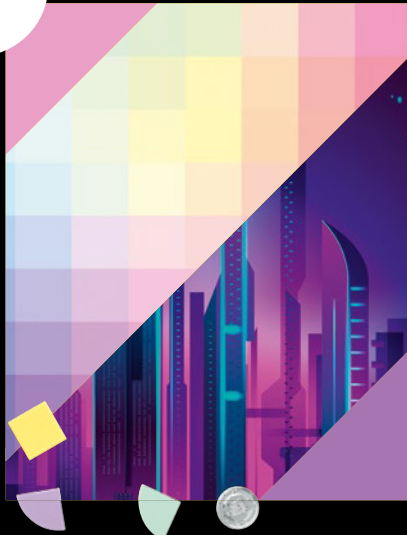

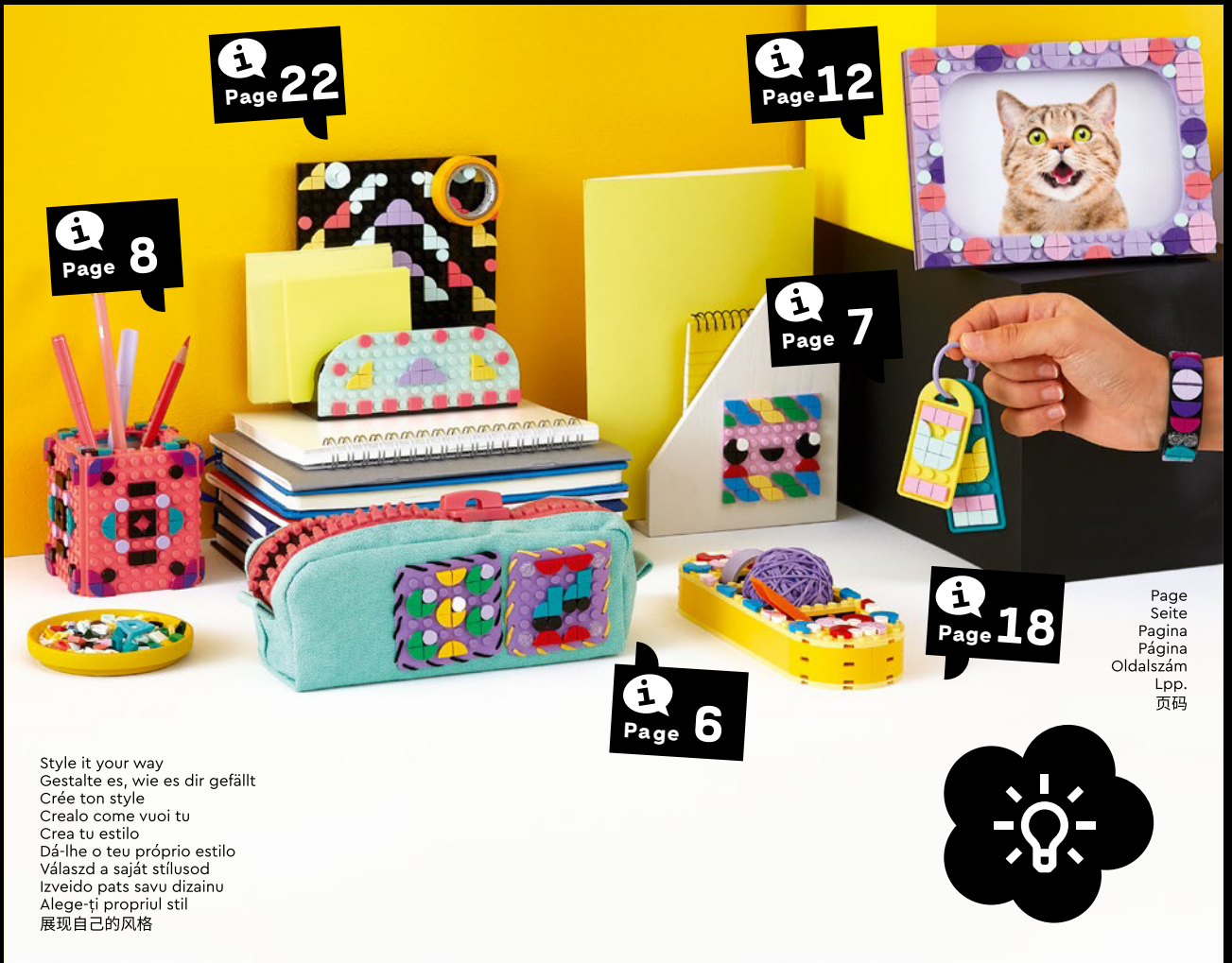

**i**  
Page 22

**i**  
Page 12

**i**  
Page 8

**i**  
Page 7

**i**  
Page 6

**i**  
Page 18

Page  
Seite  
Pagina  
Página  
Oldalszám  
Lpp.  
页码

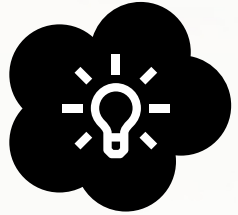

Style it your way  
Gestalte es, wie es dir gefällt  
Crée ton style  
Crea lo come vuoi tu  
Crea tu estilo  
Dá-lhe o teu próprio estilo  
Válaszd a saját stílusod  
Izveido pats savu dizainu  
Alege-ți propriul stil  
展现自己的风格

	Pastel Kawaii	Page 28-29
	Dark Digital	Page 30-31
	Fresh Primary	Page 32-33
	Black and White	Page 34-35
	Seasonal	Page 36-37

# CREATE YOUR OWN DESIGNS

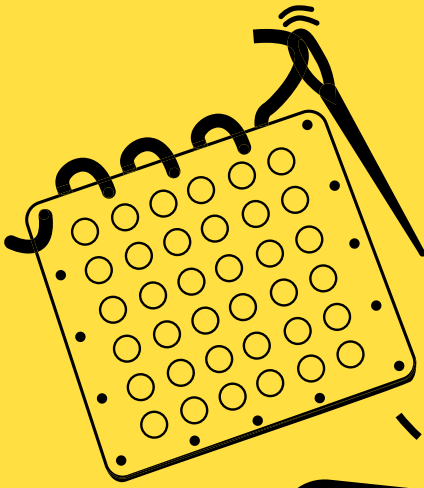

1.

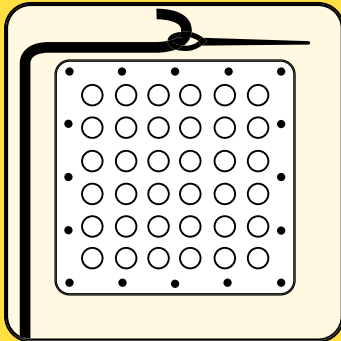

2.

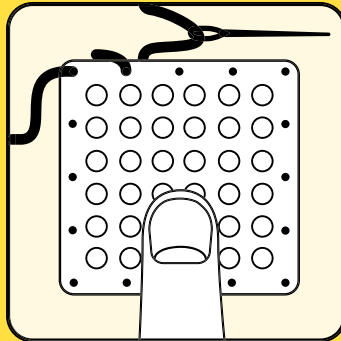

3.

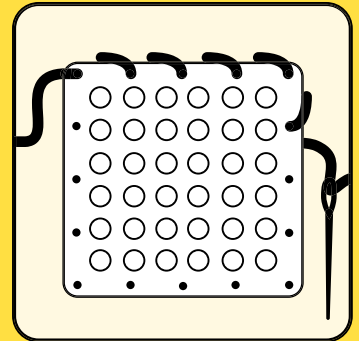

4.

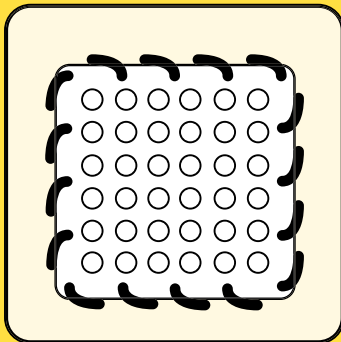

5.

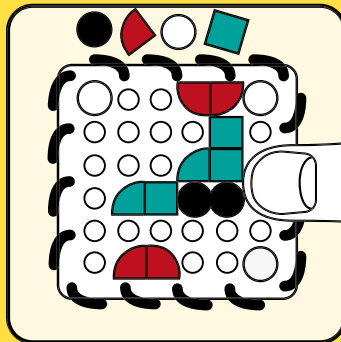

6.



Adult supervision recommended when using needle and thread  
 Es wird empfohlen, Kinder beim Verwenden von Nadel und Faden zu beaufsichtigen  
 La surveillance d'un adulte est recommandée pour l'utilisation d'un fil et d'une aiguille  
 Si raccomanda la supervizione di un adulto quando si usano ago e filo  
 Se recomienda la vigilancia de un adulto durante el uso de aguja e hilo  
 Recomenda-se a supervisão de um adulto quando forem usadas a agulha e linha  
 Felöltt felügyelete ajánlott a tű és cérna használatá közben  
 Adatu un diegu ieteicams izmantot pieaugušā uzraudzībā  
 La folosirea acului și aței recomandăm supravegherea de către un adult  
 儿童使用针线时要有成人在旁看护

Remove tiles before washing  
 Fliesen vor dem Waschen entfernen  
 Retirer les tuiles avant lavage  
 Rimuovere le tessere prima del lavaggio  
 Verwijder de tegels voor het wassen  
 Fjern mosaikker før vask  
 Fjarlæggið flísarnar fyrir þríf  
 Irrota laatat ennen pesua

Ta bort plattorna innan rengöring  
 Fjern fliser før vask  
 Retirar as peças antes de lavar  
 Αφαίρεστε τα πλακίδια πριν το πλύσιμο  
 洗前にタイルを取り外してください  
 세척하기 전에 먼저 타일을 분리하세요  
 Перед стиркой плитки необходимо снять.  
 Przed praniem należy usunąć płytki.

Před praním odstraňte zdobítka  
 Pred čištením najskôr odstráňte doštičky  
 Vedde le a csempékét mosás előtt!  
 Перед миттям зніміть плитки  
 Uklonite pločice prije pranja  
 Uklonite pločice pre pranja  
 Отстранете ги плочките пред миене  
 Pred pranjem snemite ploščice  
 Scoate plăcuțele înainte de spălare

Махнете плочките преди измиване  
 Pirms mazgāšanas elementi ir jānoņem  
 Eemalda enne pesemist detailid  
 Nuimkrite plyteles prieš skalbdami  
 Yıkamadan önce karoları çıkarın  
 يرجى إزالة القطع قبل الغسيل  
 Lepaskan ubin sebelum mencuci  
 Buang jubin sebelum membasuh

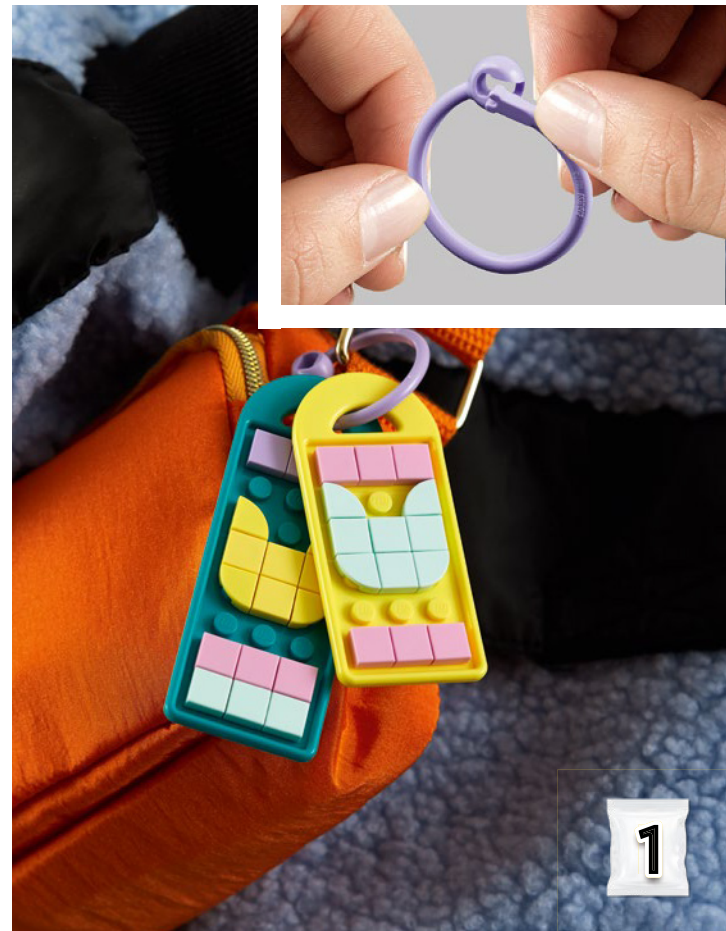
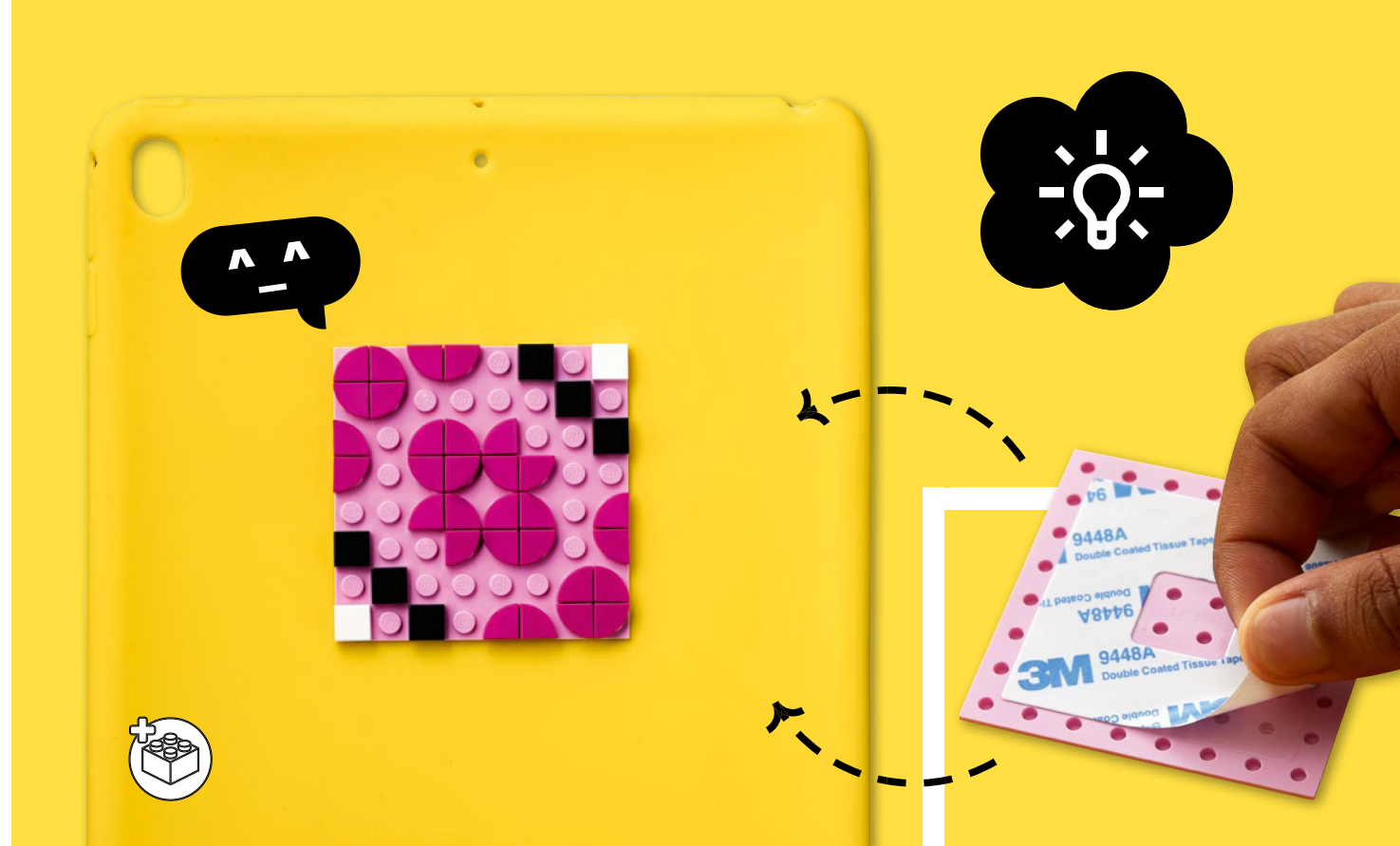

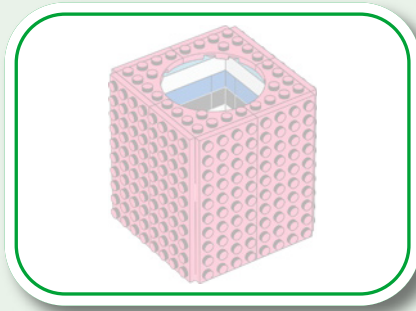

1

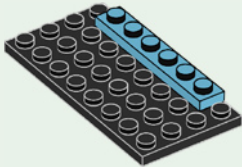

3

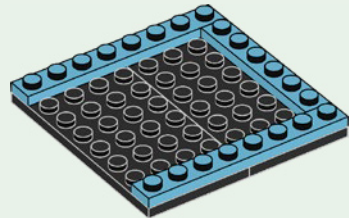

2

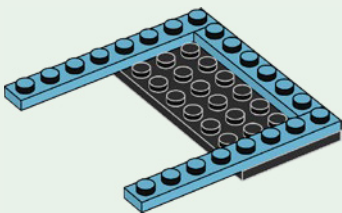

4

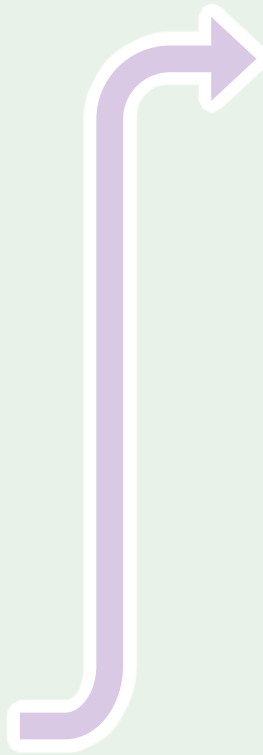
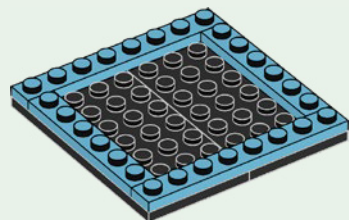



5

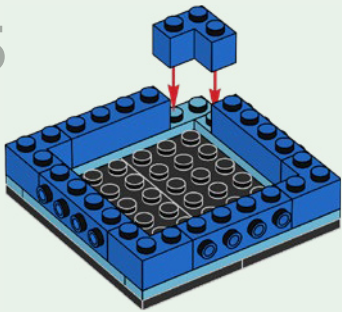

7

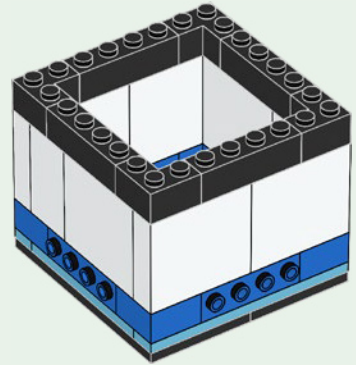

6

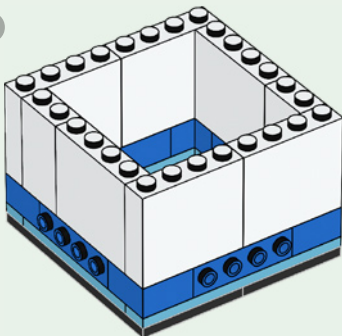

8

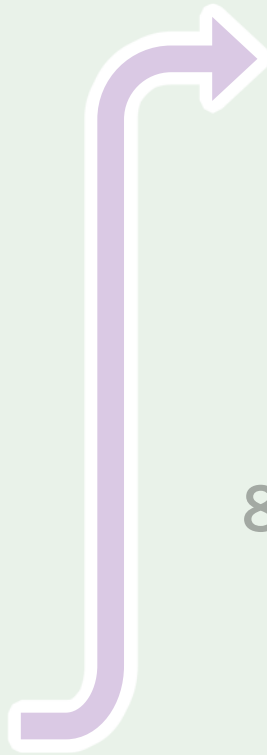
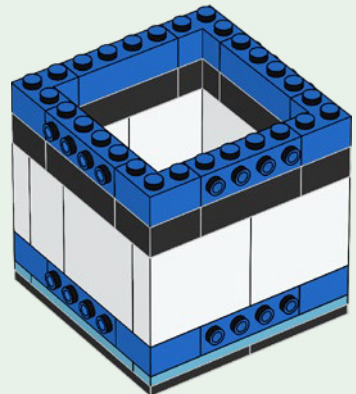

9

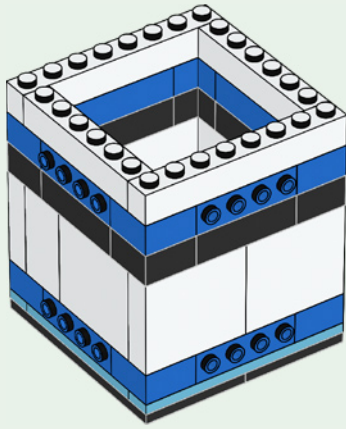

11

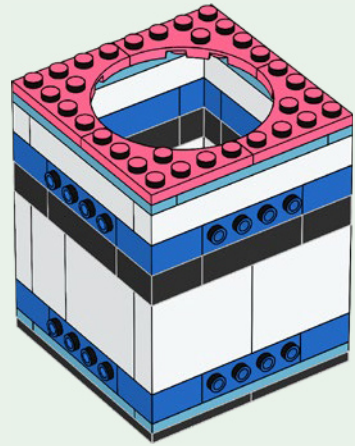

10

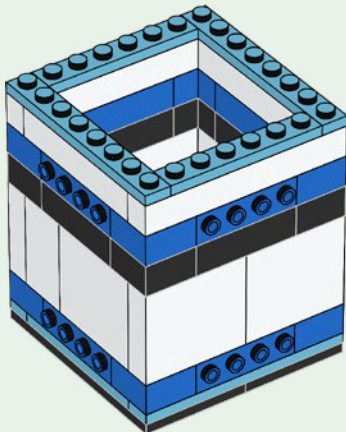

12

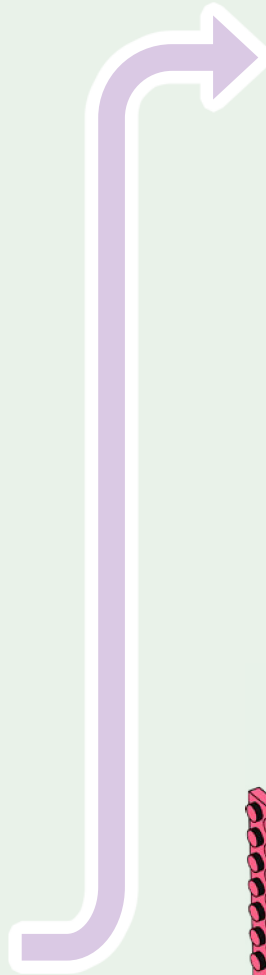
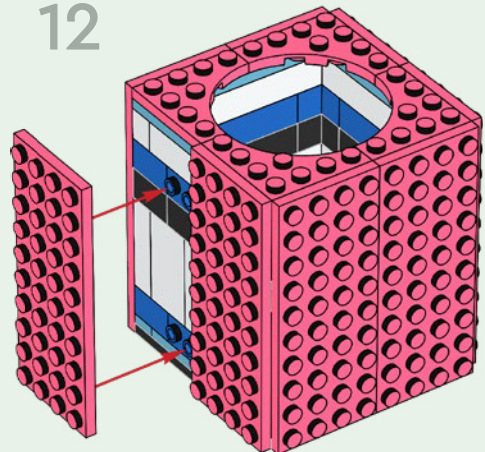

**CREATE  
YOUR OWN  
DESIGNS**



**MORE  
STYLES  
PAGE 28-37**

More styles page 28-37  
Weitere Muster findest du auf Seite 28-37  
Plus de styles page 28-37  
Più stili a pagina 28-37  
Más estilos en la página 28-37  
Mais estilos na página 28-37  
További stílusok a(z) 28-37 oldalon  
Citas dizaina idejas: 28-37. lpp.  
Mai multe stiluri pe pagina 28-37  
可从第 28-37 页找到更多风格样式

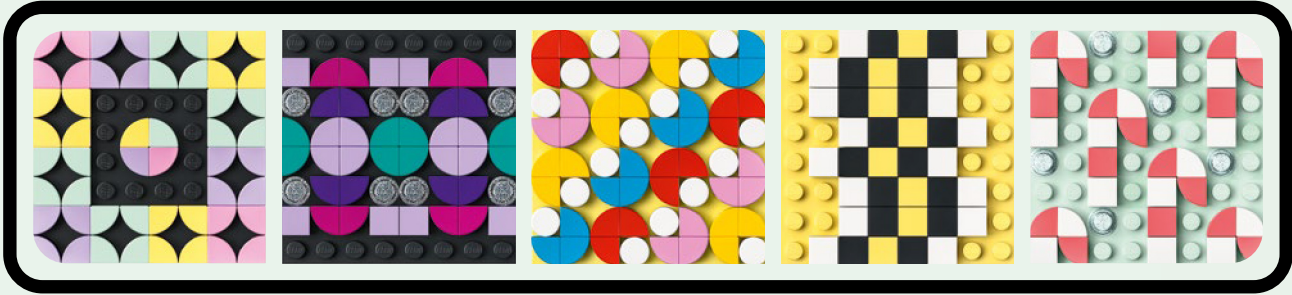

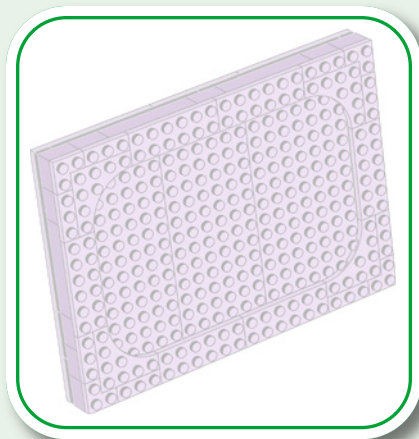
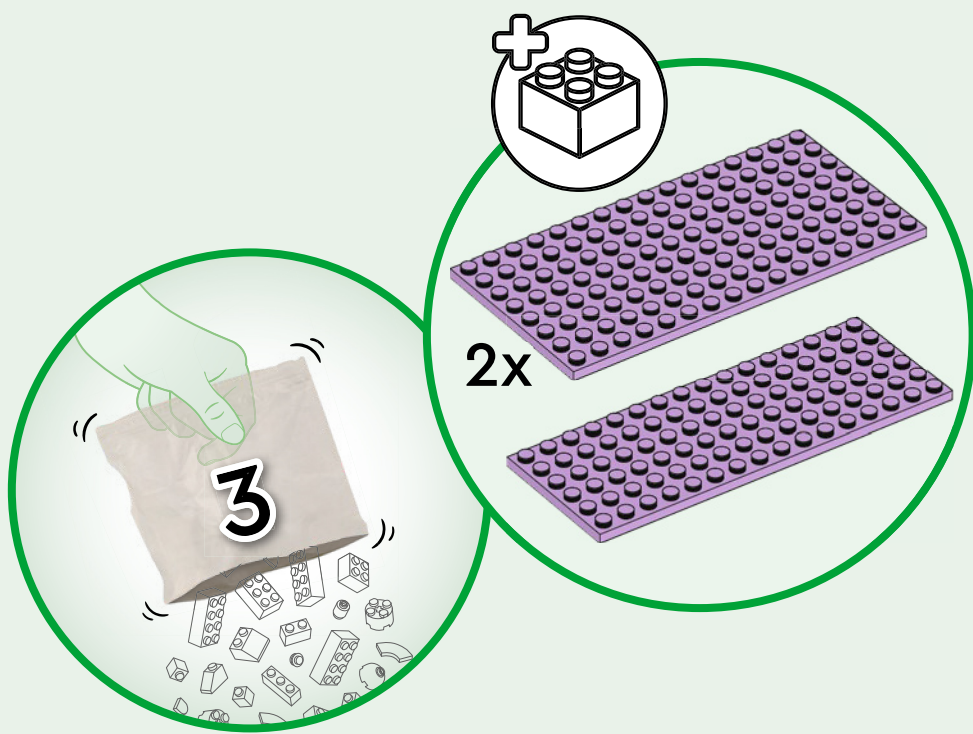

1

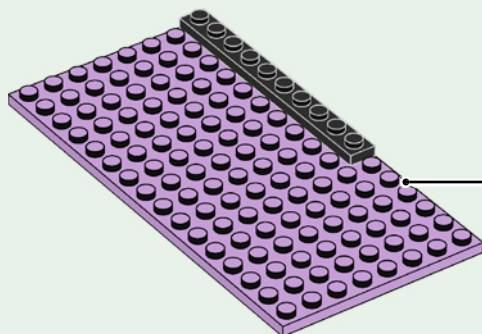

2

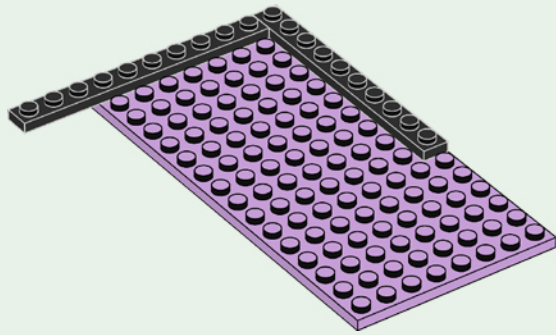

3

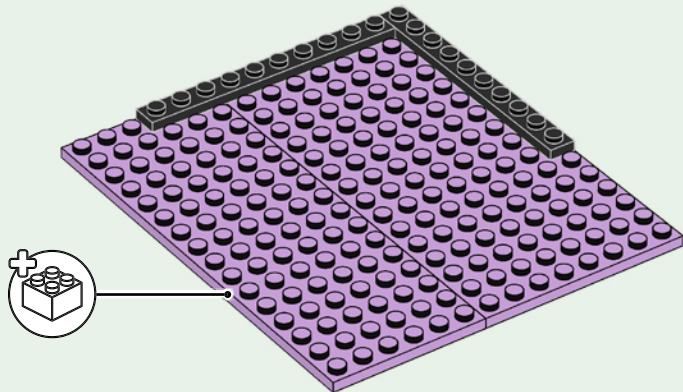

4

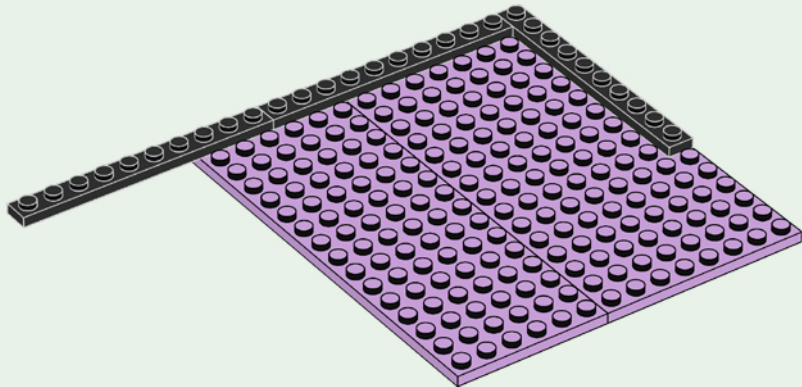

5

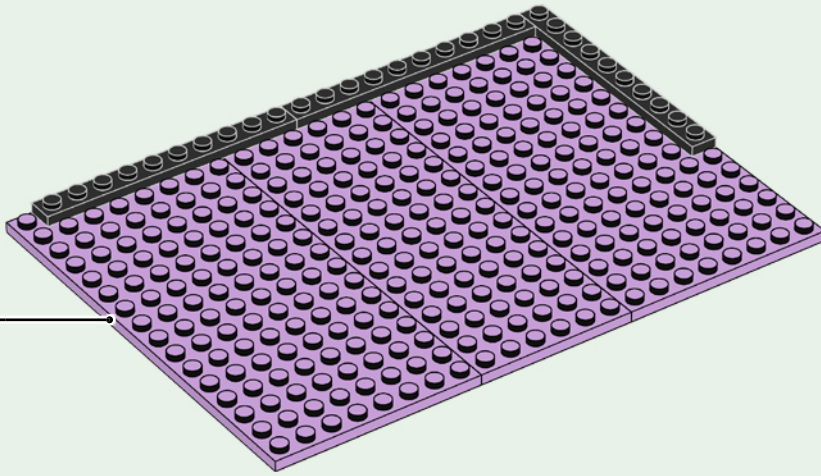

6

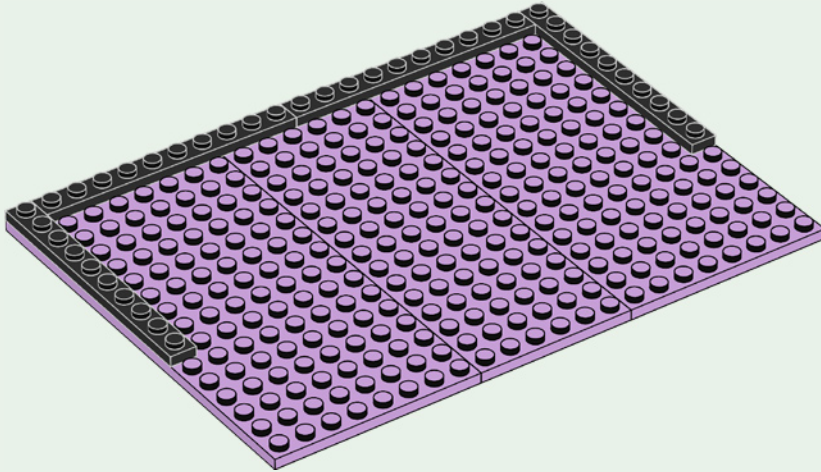

7

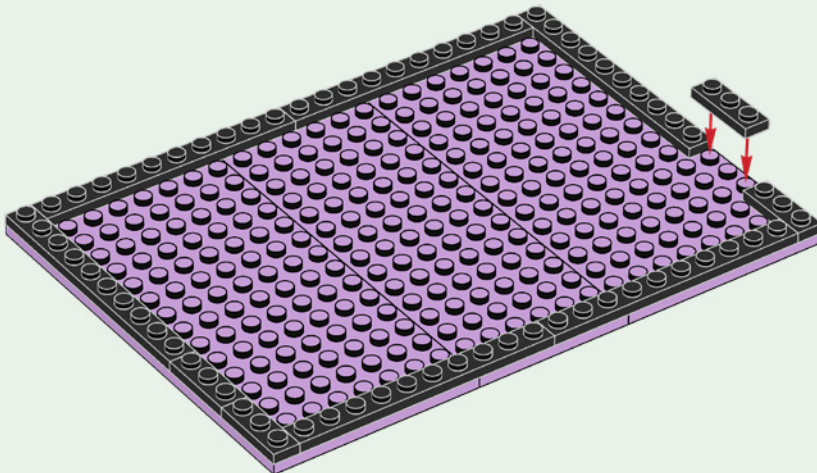

8

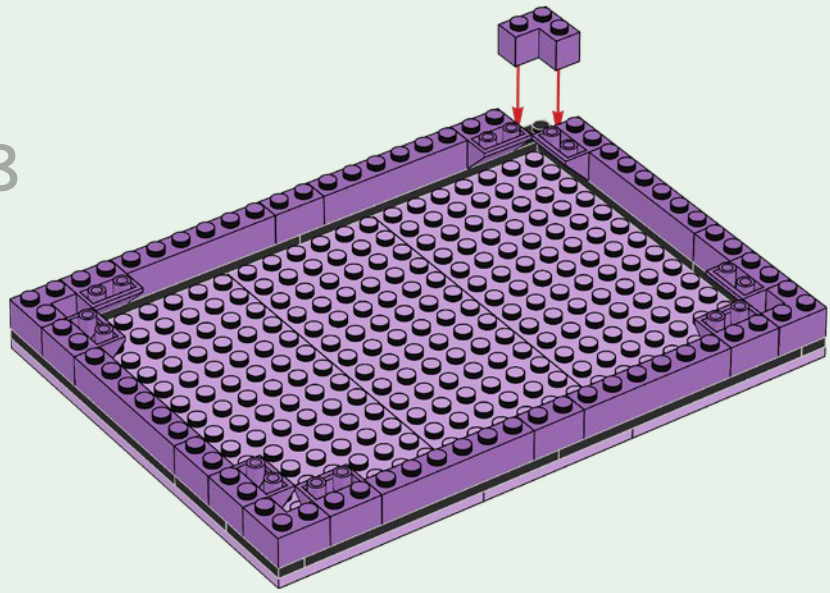

9

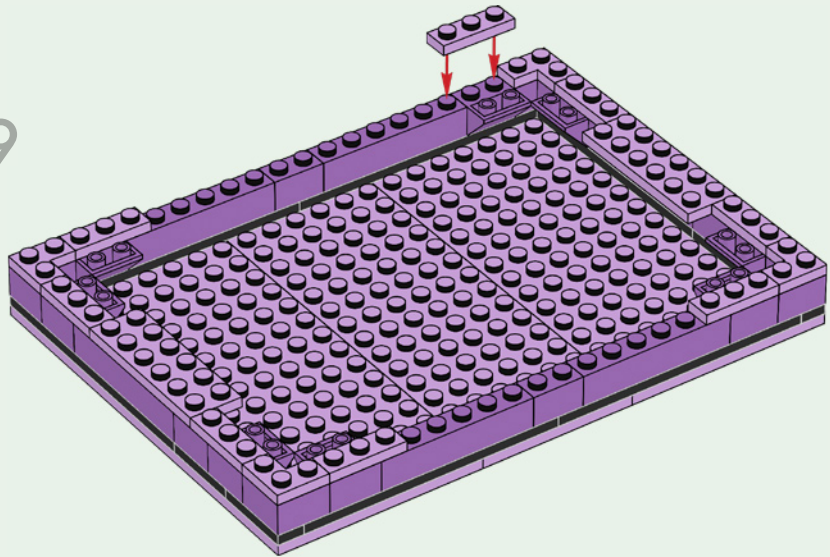

10

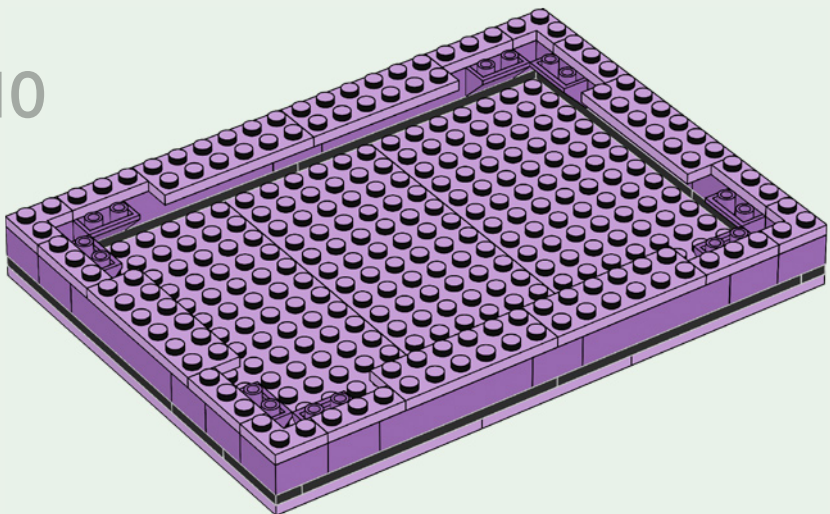

11

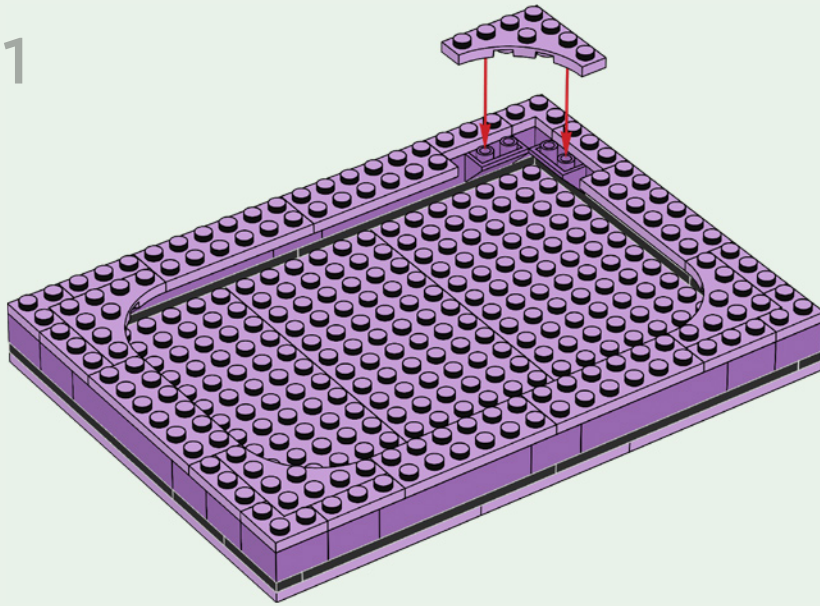

12

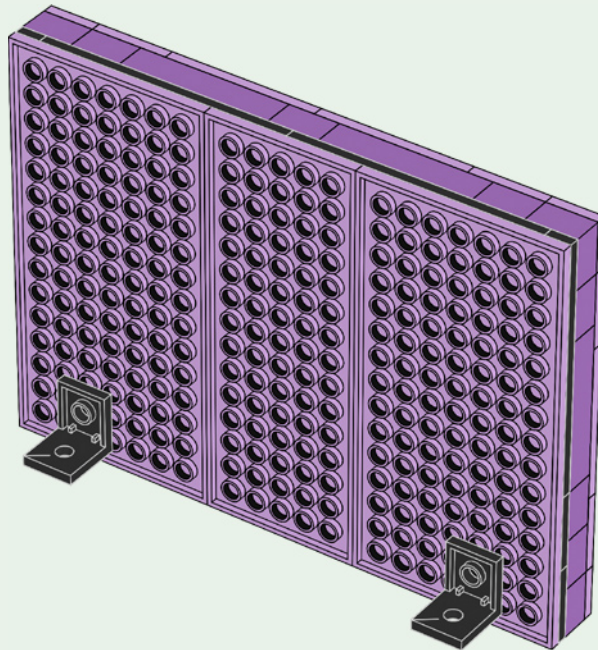



**CREATE  
YOUR OWN  
DESIGNS**



**MORE  
STYLES  
PAGE 28-37**

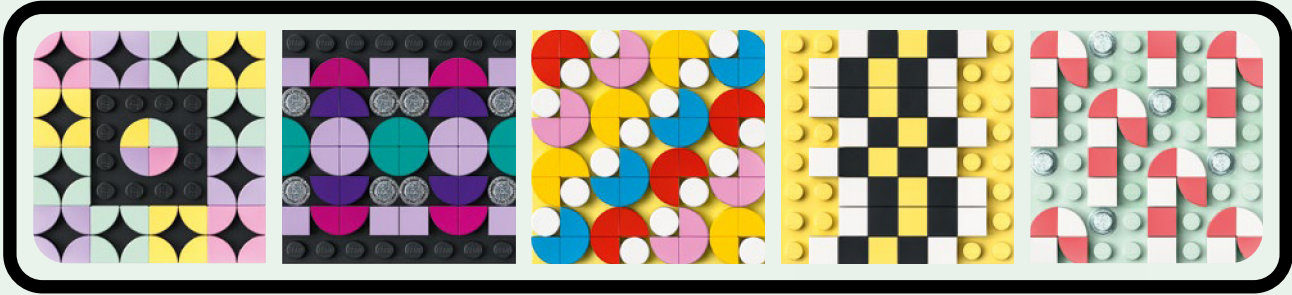

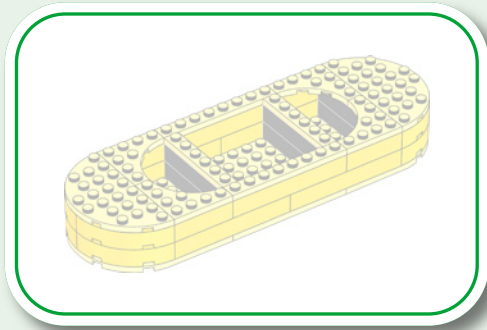
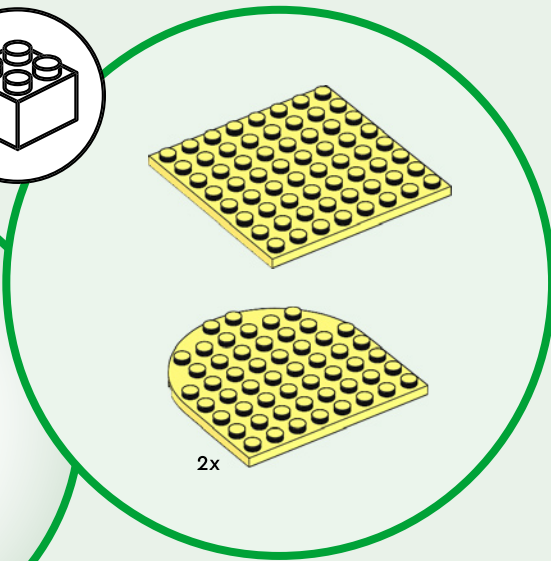
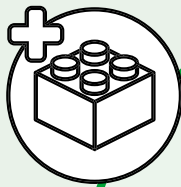

1

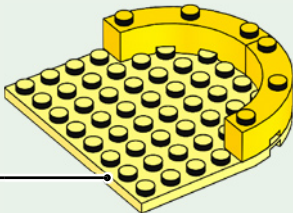

3

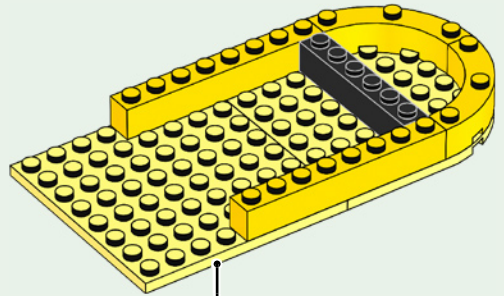

2

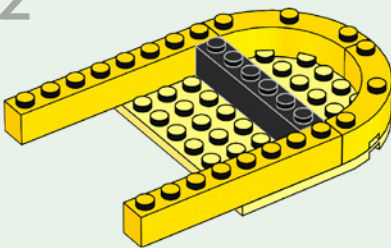

4

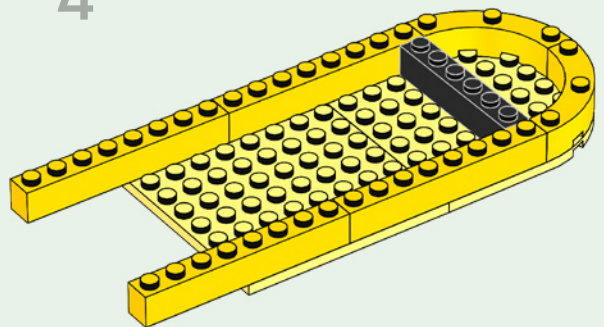

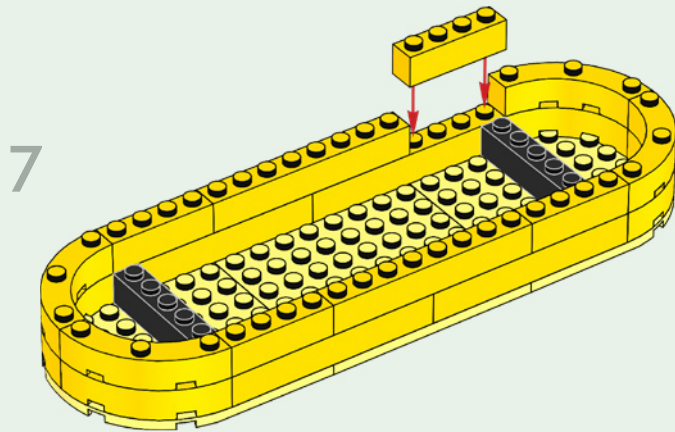
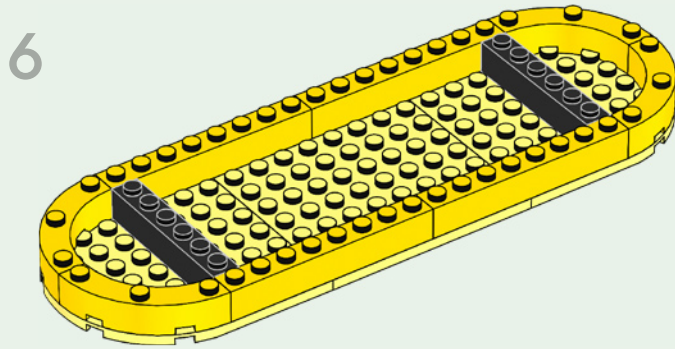
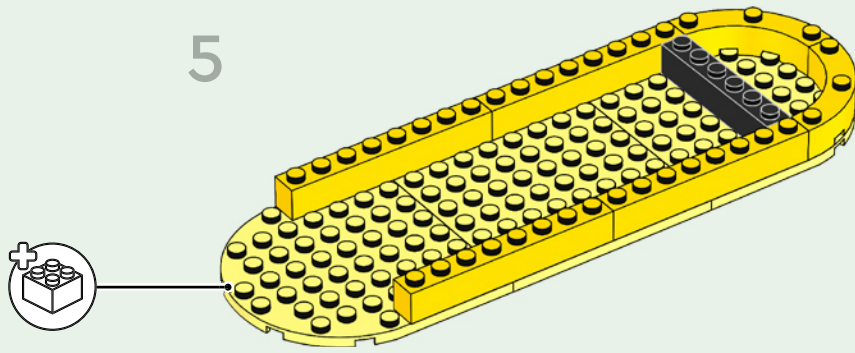

8

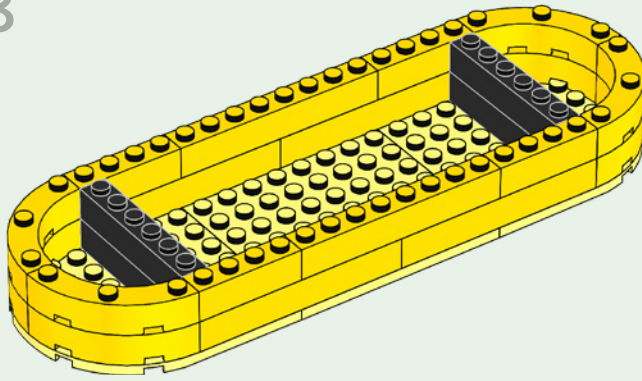

9

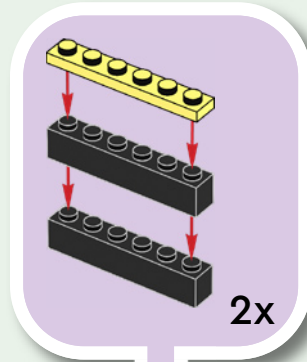
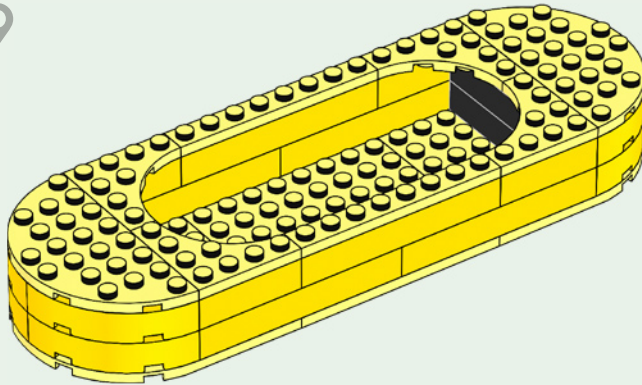

10

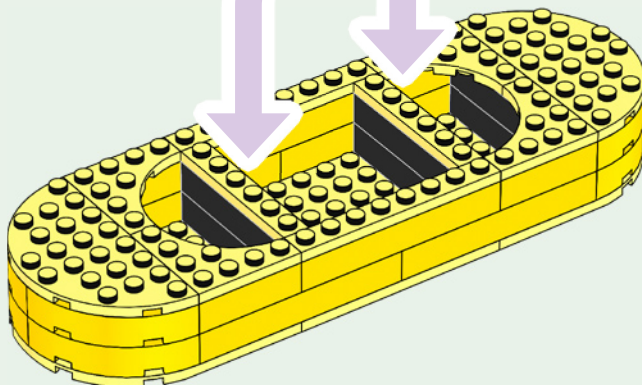

**CREATE  
YOUR OWN  
DESIGNS**



**MORE  
STYLES  
PAGE 28-37**

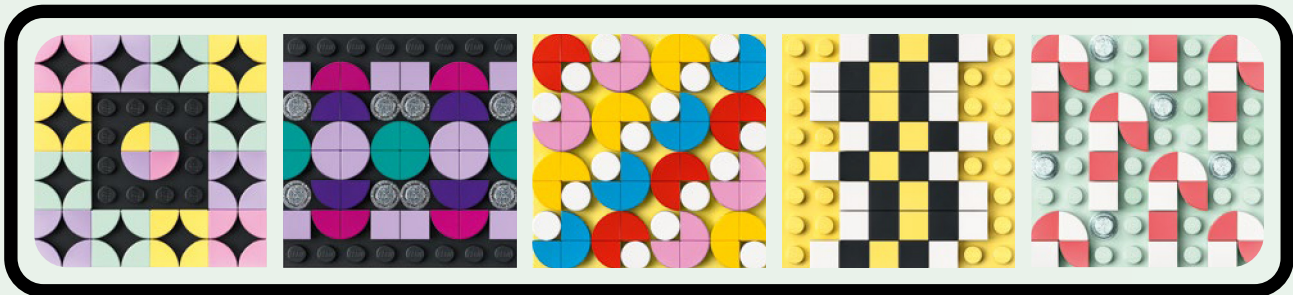

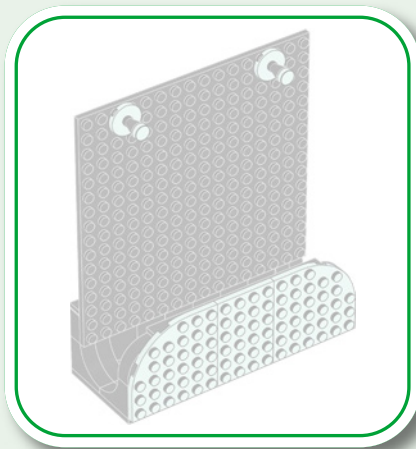
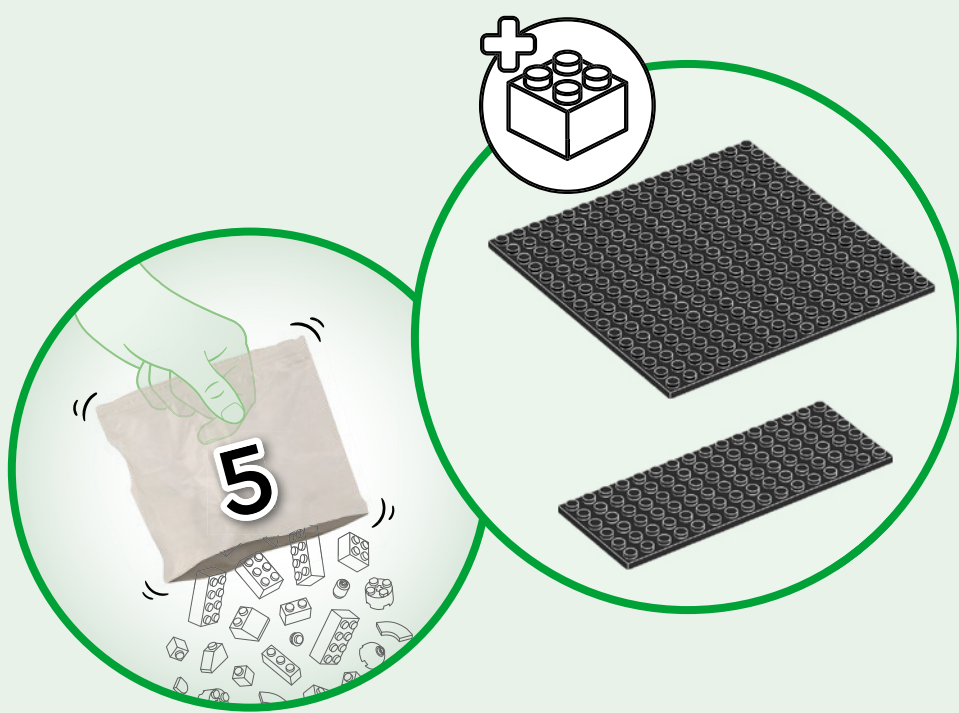

1

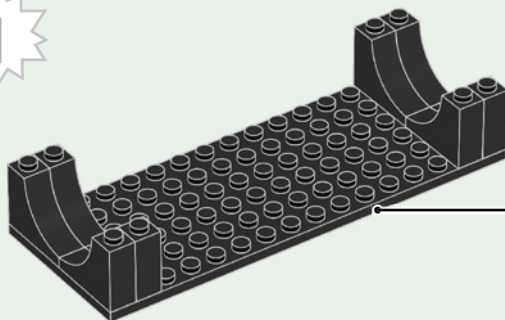

2

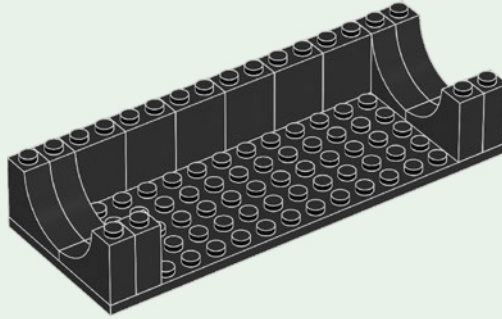

3

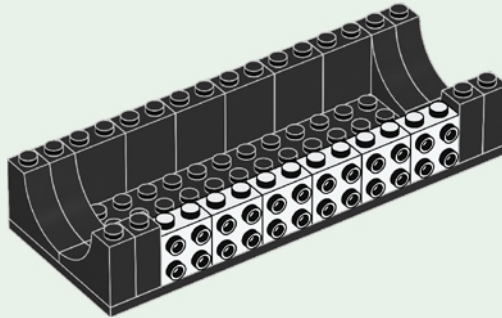

4

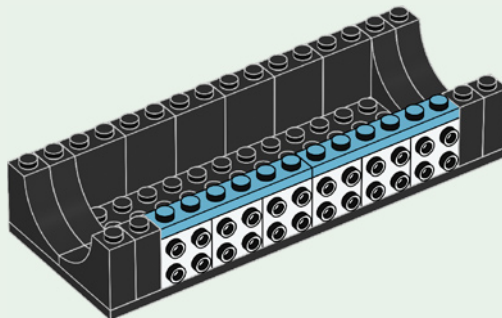

5

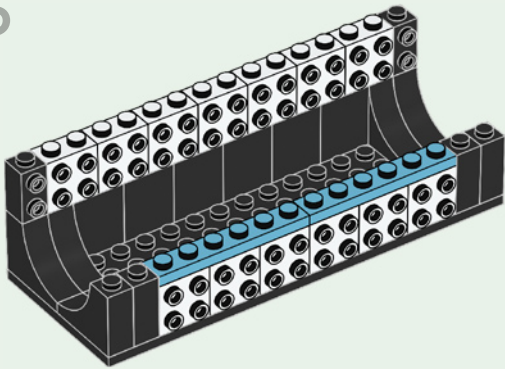

7

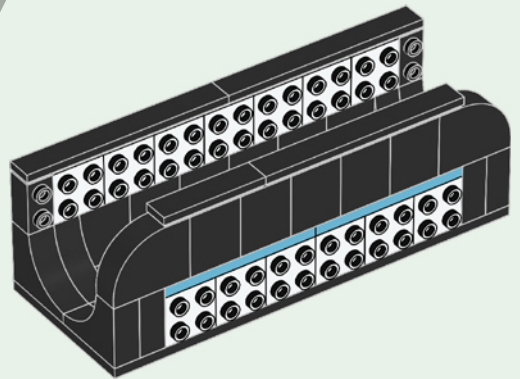

6

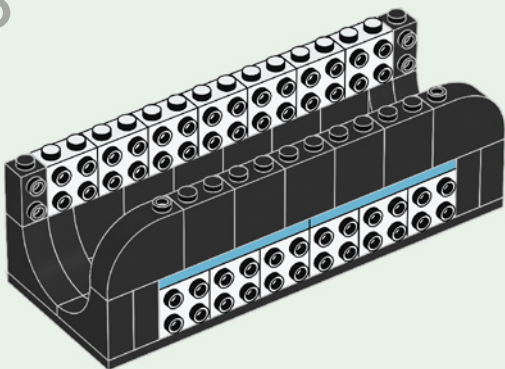

8

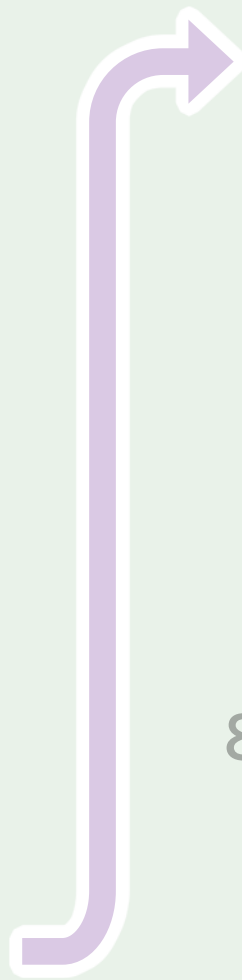
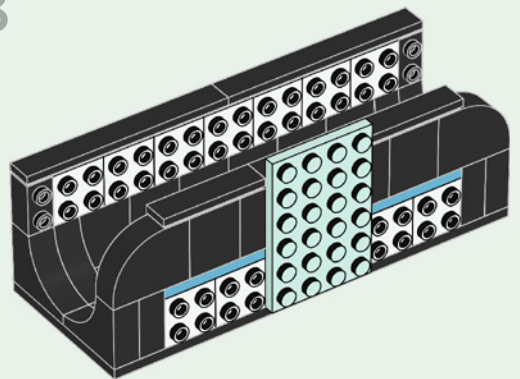



9

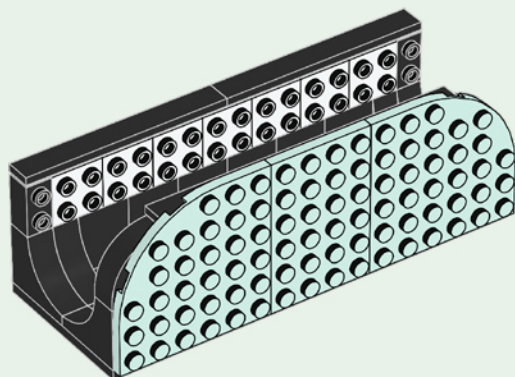

10

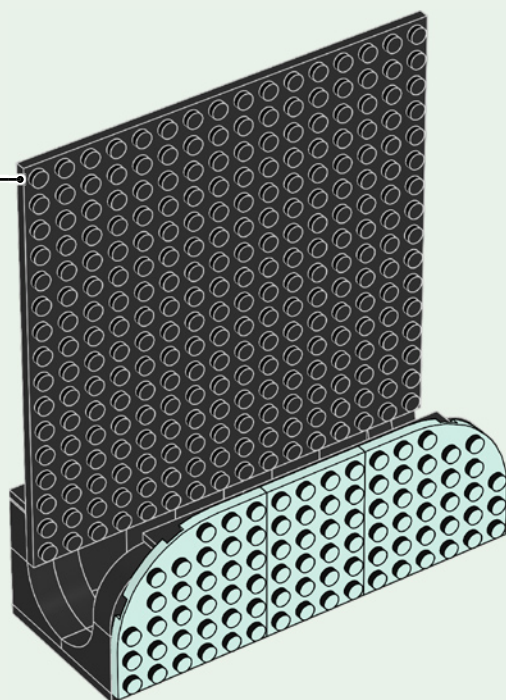

11

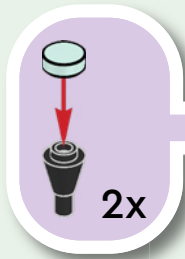
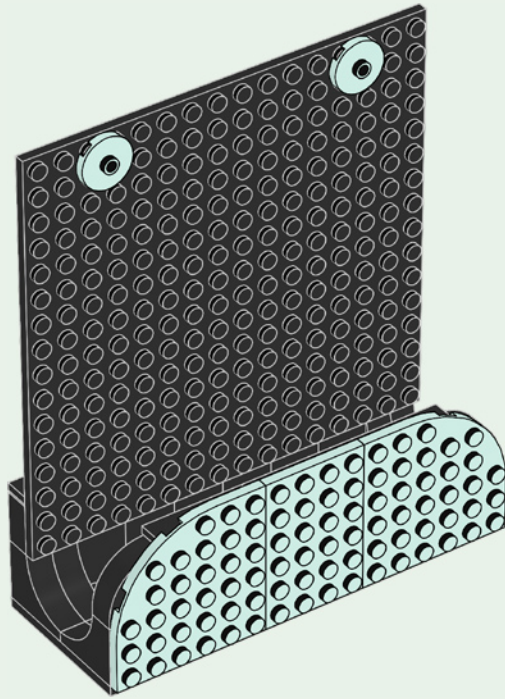

12

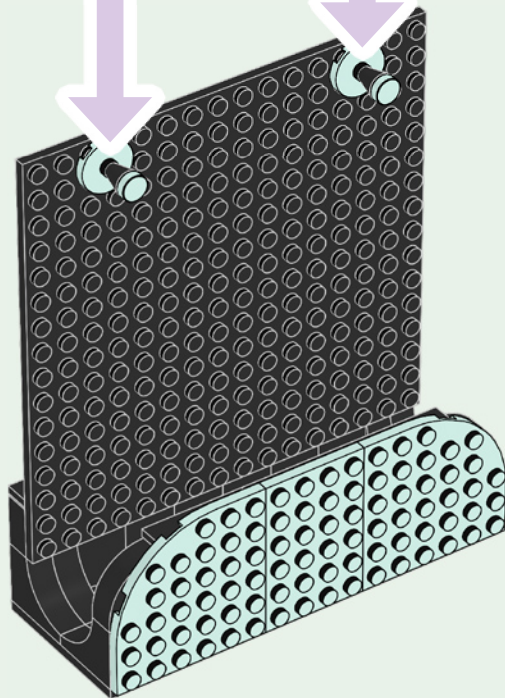

**CREATE  
YOUR OWN  
DESIGNS**



**MORE  
STYLES  
PAGE 28-37**

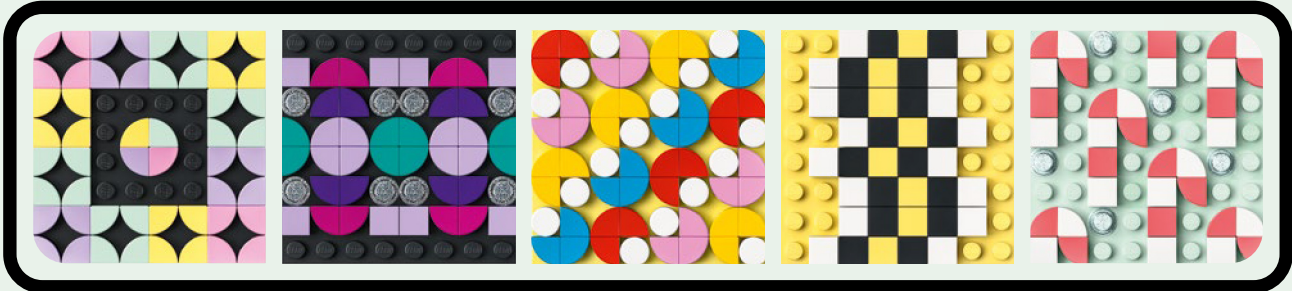

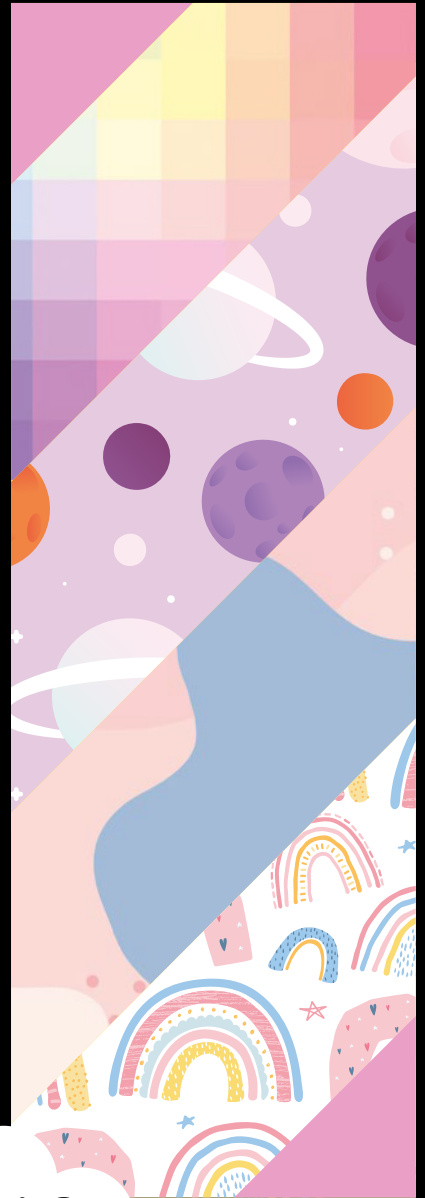
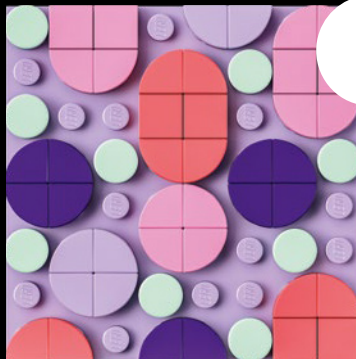
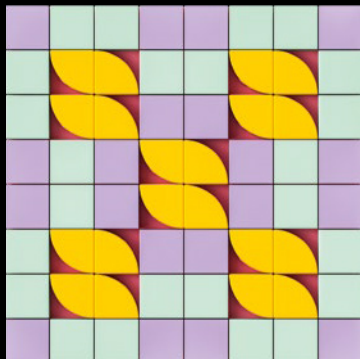
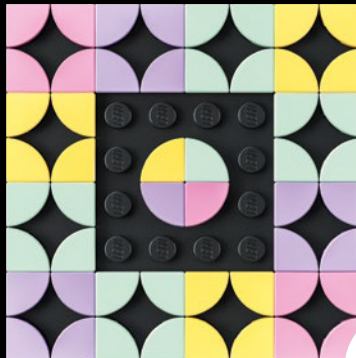
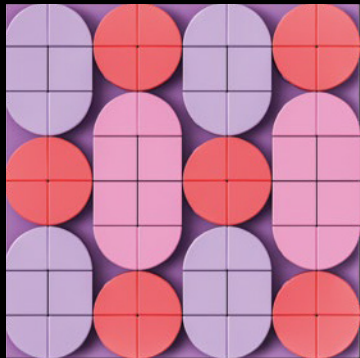
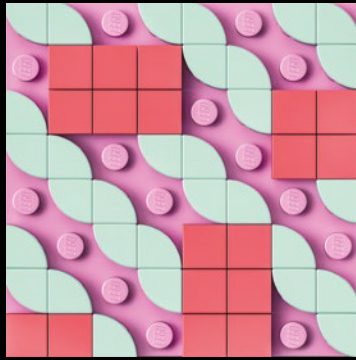
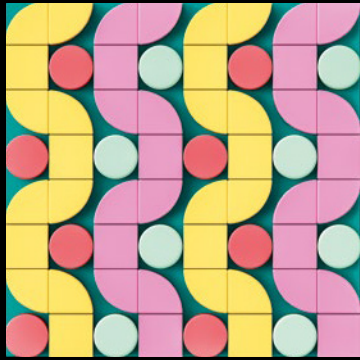

**CREATE  
YOUR OWN  
DESIGNS**

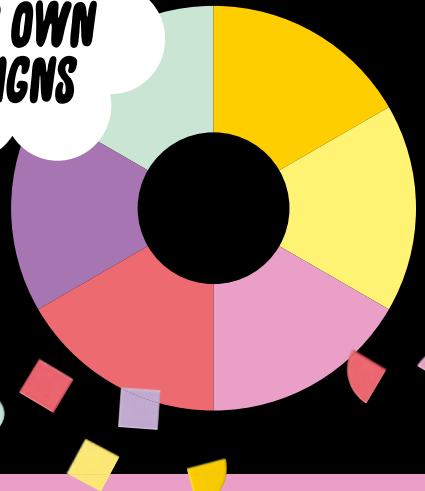

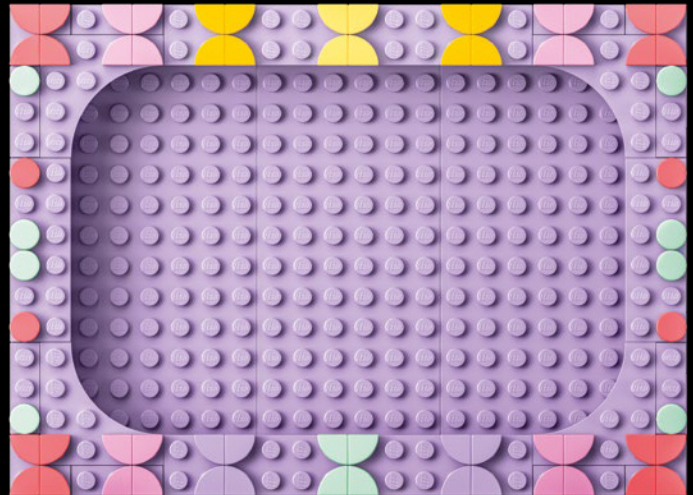
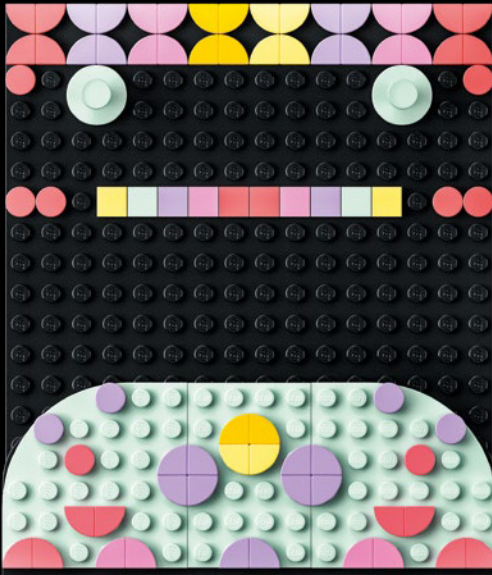
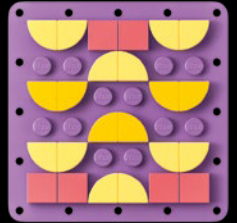
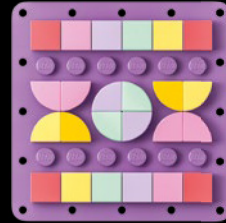
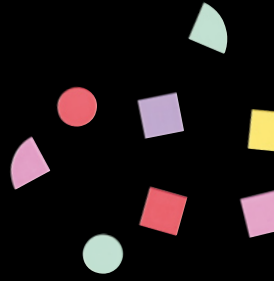
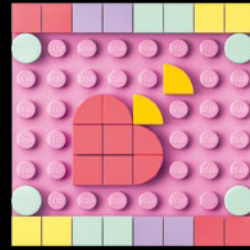
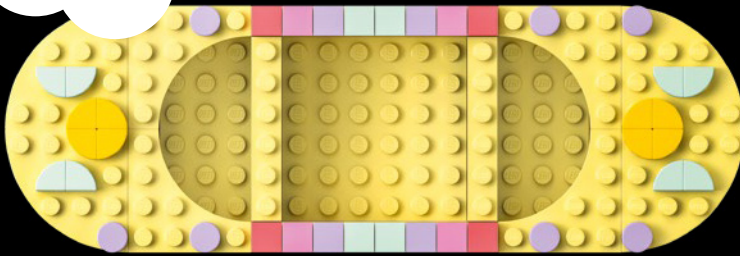
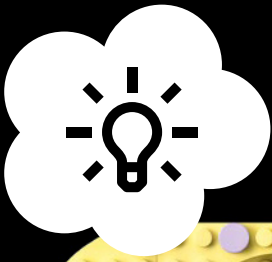

Pastel Kawaii  
Pastell-Kawaii  
Pastel Kawaii  
Pastello Kawaii  
Kawaii Pastel  
Piemiligi pasteltoni

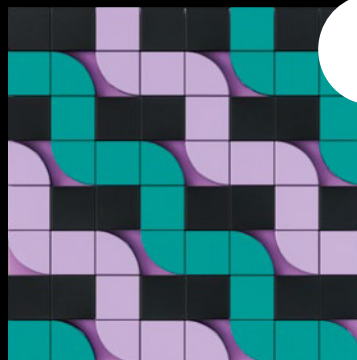
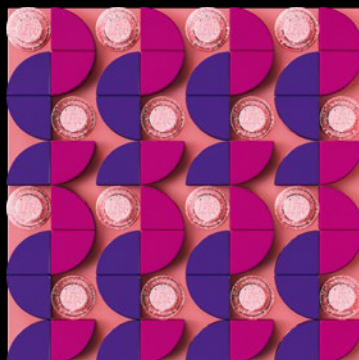
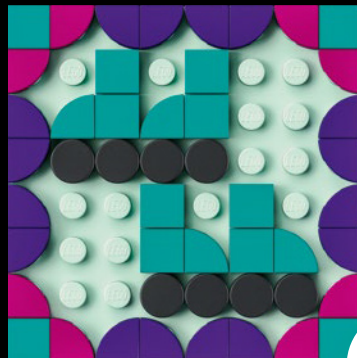
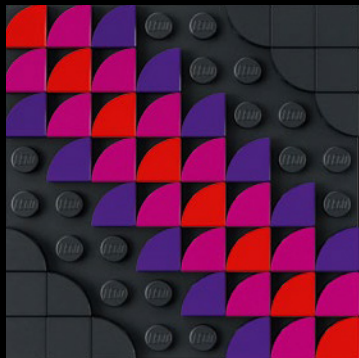
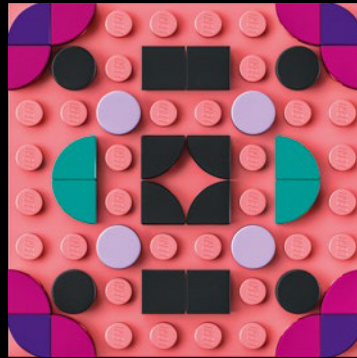
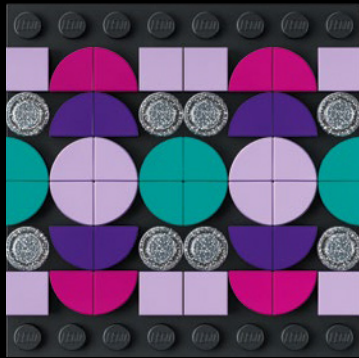

**CREATE  
YOUR OWN  
DESIGNS**

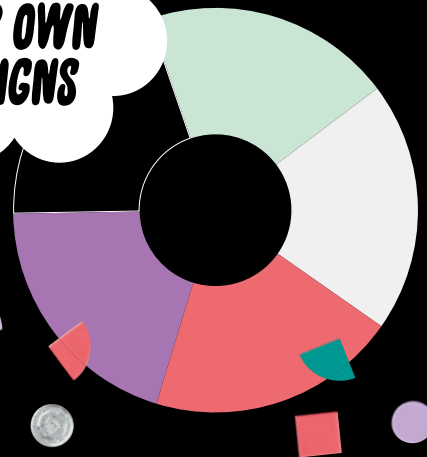

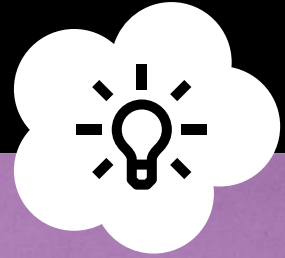
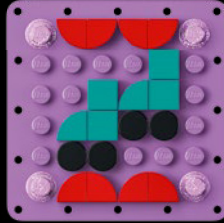
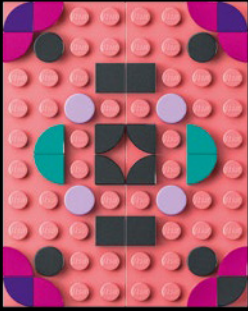

Dark Digital  
Dunkles Digitalmuster  
Numérique sombre  
Digital Profundo  
Escuro digital  
Tumša digitāla  
酷黑数字



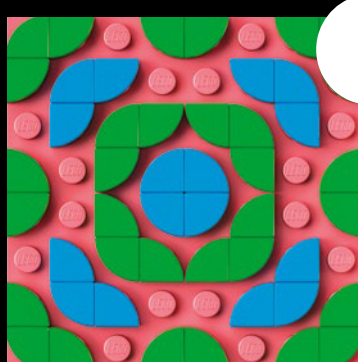
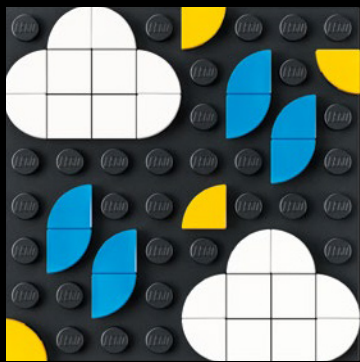
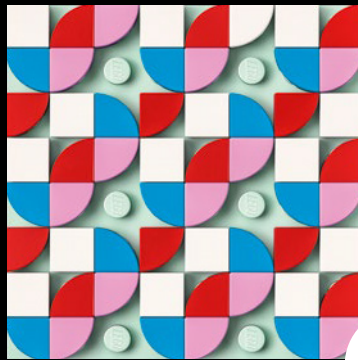
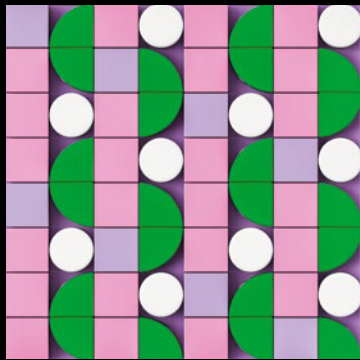
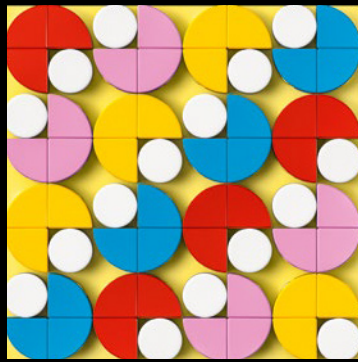
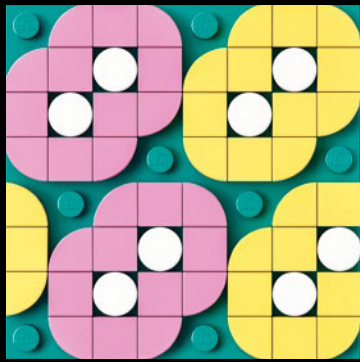

**CREATE  
YOUR OWN  
DESIGNS**

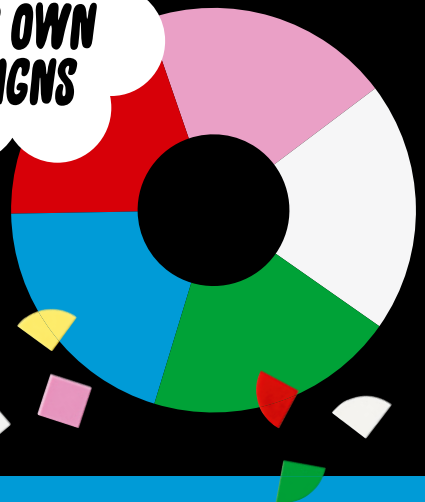



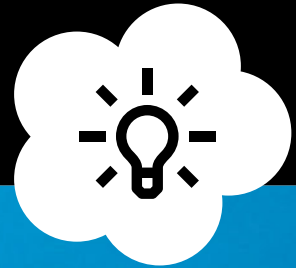
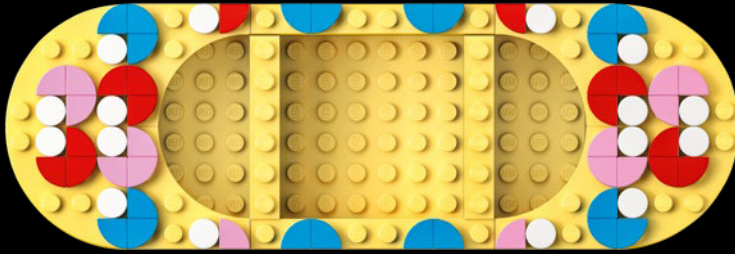
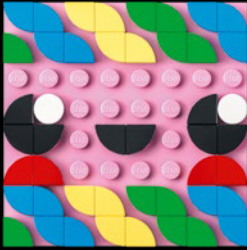

Fresh Primary  
 Frische Primärfarben  
 Primaires éclatantes  
 Primario  
 Primários Frescos  
 Primário Fresco  
 Svaīgs sākums  
 清新原色

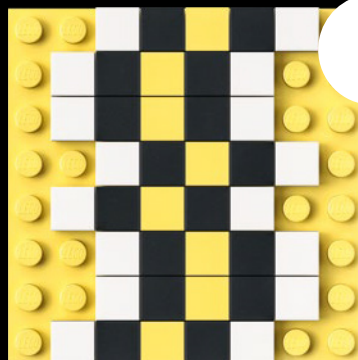
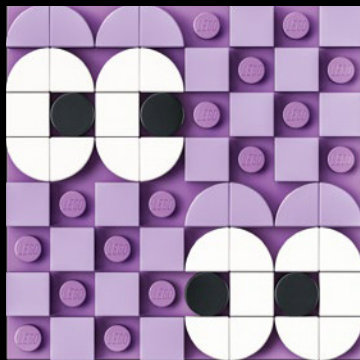
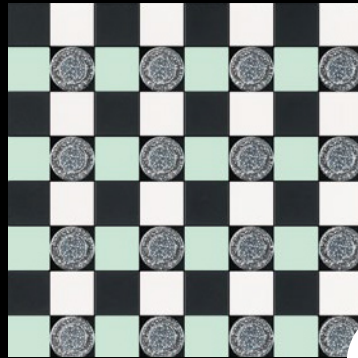
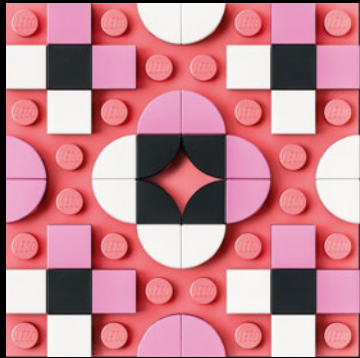
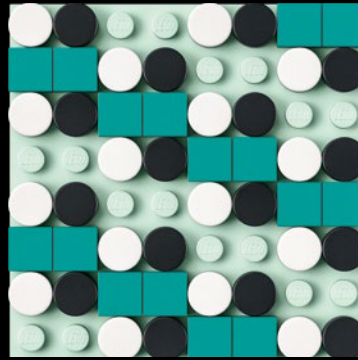
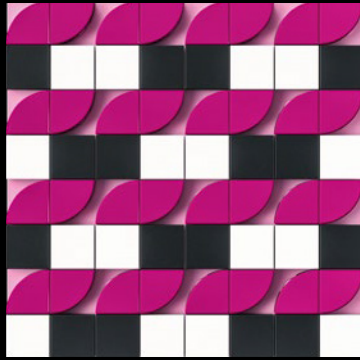

**CREATE  
YOUR OWN  
DESIGNS**

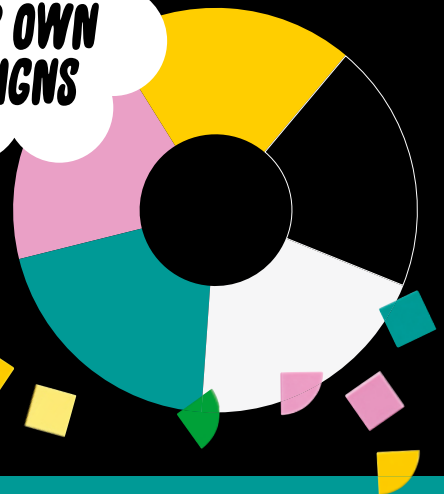

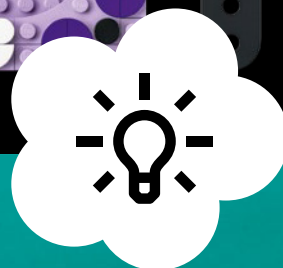
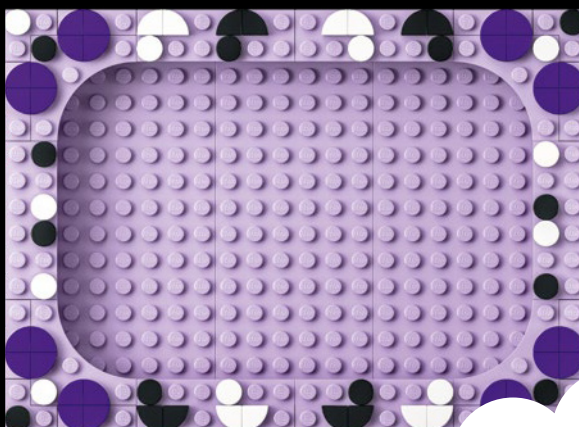
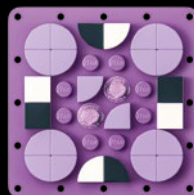
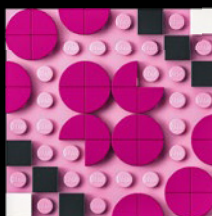
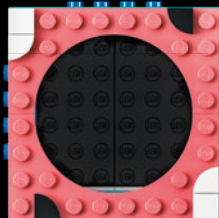
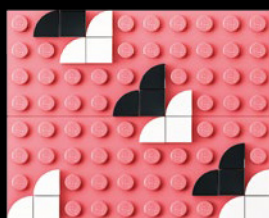
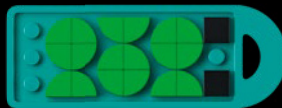
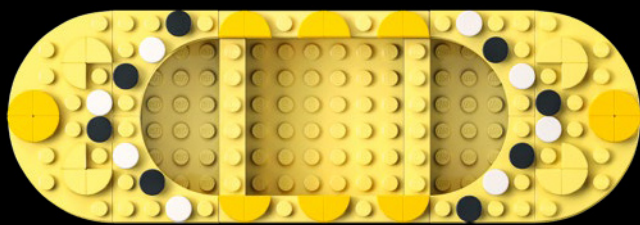

Black & White  
Schwarz-weiß  
Noir et blanc  
Bianco e Nero  
Blanco y Negro

Preto e Branco  
Fekete & Fehér  
Melnbalta  
Alb-negru  
黑白相间



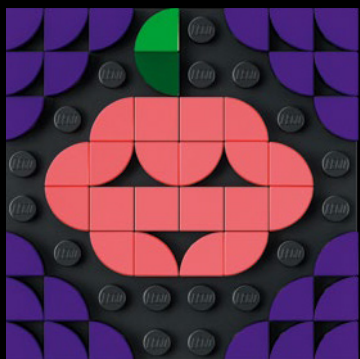
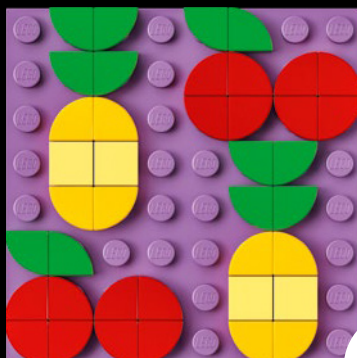
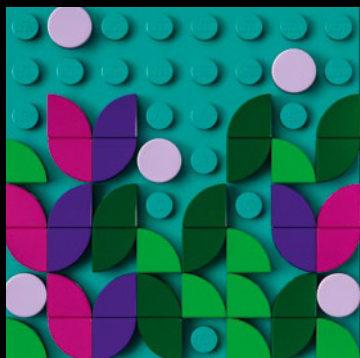
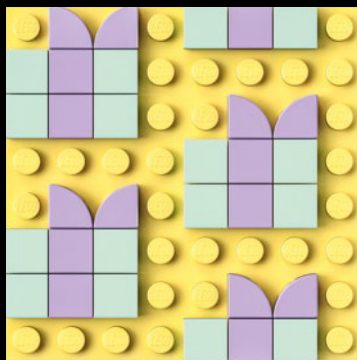
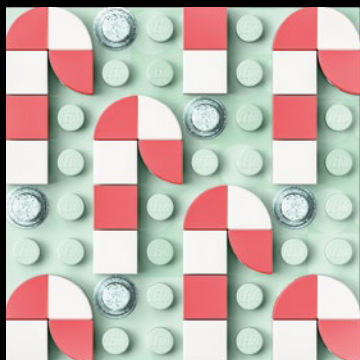
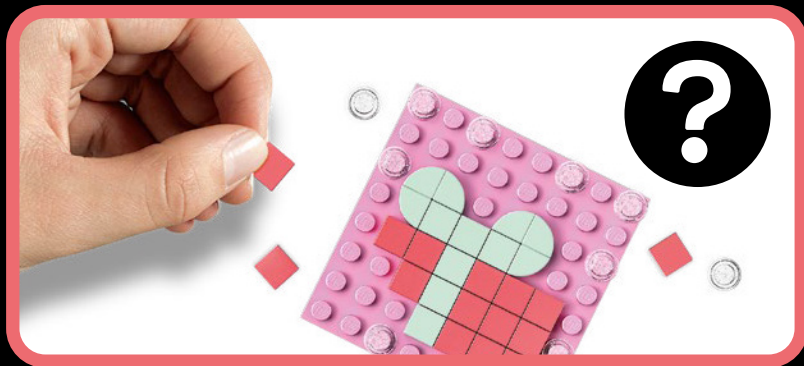

**CREATE  
YOUR OWN  
DESIGNS**

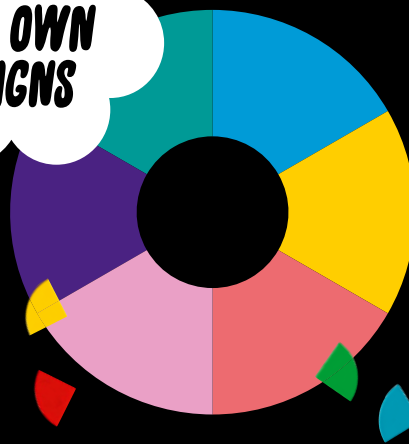

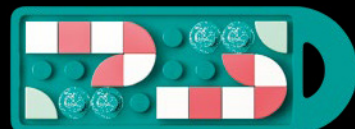
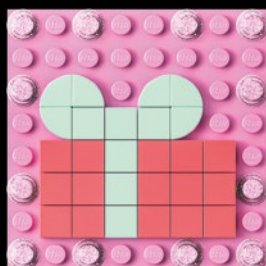
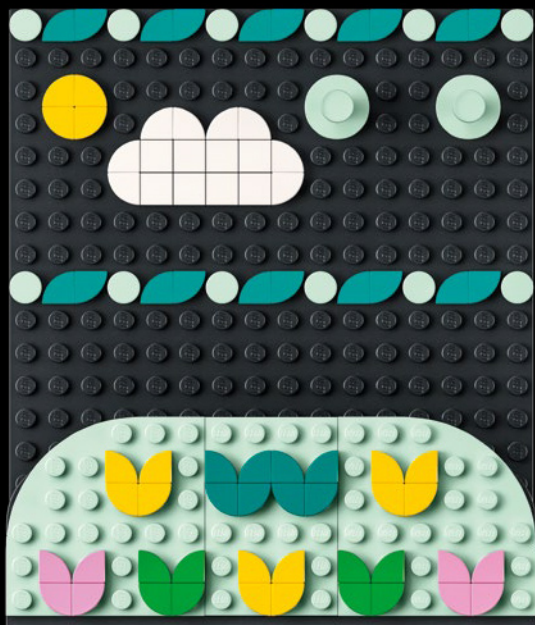

Seasonal  
Saisonal  
Saison  
Stagionale  
Festivo  
Sazonal  
Unnepi  
Sezonāla  
De sezon  
应季新品

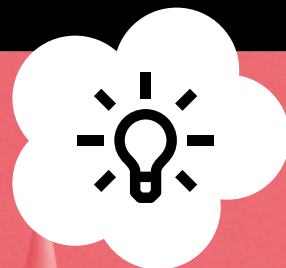

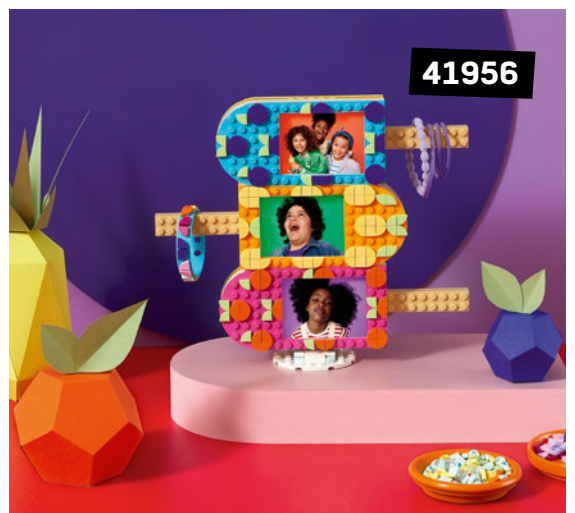
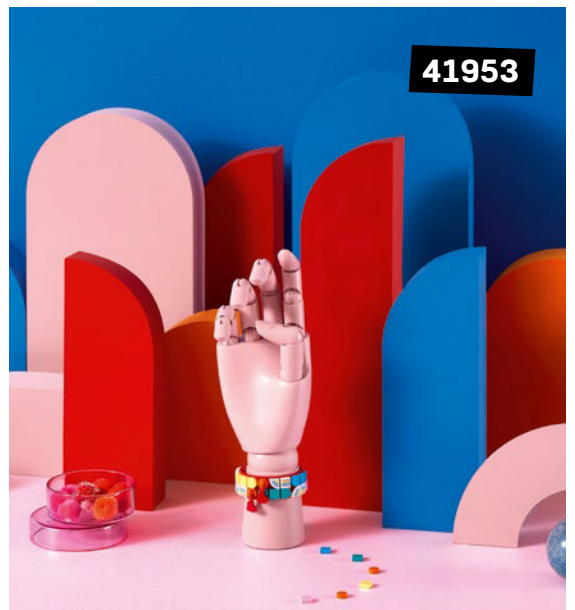
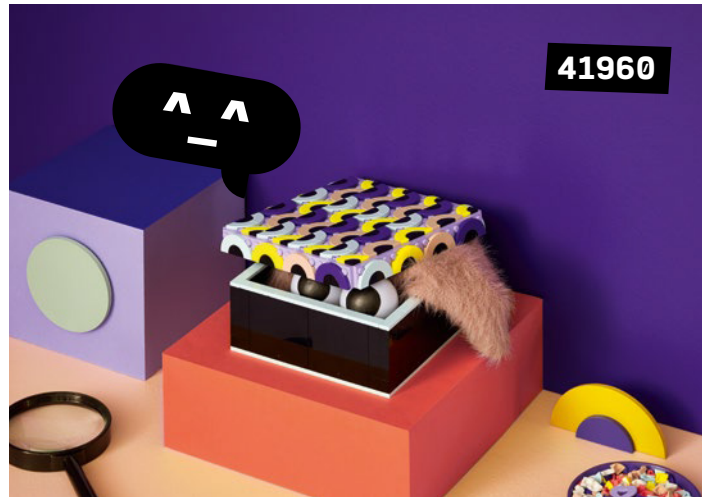
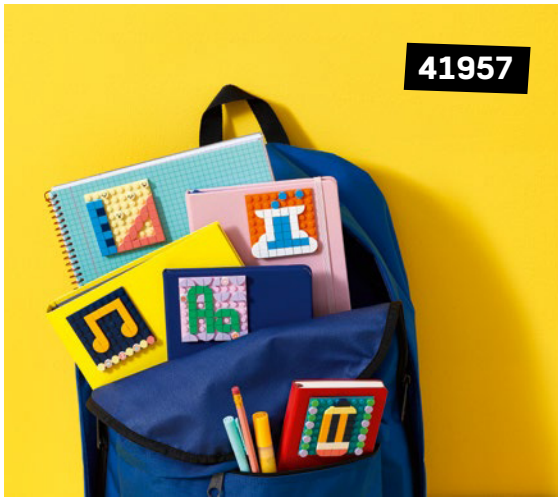

#youDOTyou

41954

41953

41957

41955



Customer Service  
Kundenservice  
Service Client  
Assistenza clienti  
Atención al cliente  
Serviço de Apoio ao Consumidor  
Ügyfélszolgálat  
Klientu apkalpošanas dienests  
Serviciul pentru clienț  
客户服务  
コンシューマーサービス  
고객 서비스  
**LEGO.com/service**

# WIN

Scan this QR code or go to [LEGO.COM/PRODUCTFEEDBACK](https://LEGO.COM/PRODUCTFEEDBACK) and give us your short feedback about this LEGO® set for a chance to win a cool LEGO prize.



Terms & Conditions apply

## GEWINNE

Scanne diesen QR-Code oder geh auf [LEGO.COM/PRODUCTFEEDBACK](https://LEGO.COM/PRODUCTFEEDBACK)

und gib uns dein kurzes Feedback zu diesem LEGO® Set. Dann hast du die Chance, einen coolen LEGO Preis zu gewinnen.

Es gelten die Teilnahmebedingungen

## 获取奖品

只需扫描此二维码或访问 [LEGO.COM/PRODUCTFEEDBACK](https://LEGO.COM/PRODUCTFEEDBACK),

就这款乐高®套装提供简短反馈, 就有机会赢得很酷的乐高奖品。

《条款及条件》适用

## GAGNE

Scannez ce code QR ou rendez-vous sur [LEGO.COM/PRODUCTFEEDBACK](https://LEGO.COM/PRODUCTFEEDBACK)

pour donner votre avis sur ce produit LEGO® et avoir une chance de gagner un prix LEGO.

Voir Conditions Générales

## 경품 당첨 기회

이 QR 코드를 스캔하거나 [LEGO.COM/PRODUCTFEEDBACK](https://LEGO.COM/PRODUCTFEEDBACK)

페이지에 접속하여 이 레고® 세트에 대한 간략한 피드백을 적어주시고, 멋진 레고 상품을 받을 기회를 잡으세요.

약관 적용

## GANA

Escanea este código QR o visita [LEGO.COM/PRODUCTFEEDBACK](https://LEGO.COM/PRODUCTFEEDBACK)

y comparte con nosotros tu opinión sobre este set LEGO® para tener la oportunidad de ganar un fantástico premio LEGO.

Términos y Condiciones aplicables

## ЗАПОЛНИ АНКЕТУ И ПОЛУЧИ ПРИЗ

Отсканируйте этот код или перейдите на веб-сайт [LEGO.COM/PRODUCTFEEDBACK](https://LEGO.COM/PRODUCTFEEDBACK),

чтобы оставить краткий отзыв об этом наборе LEGO® и выиграть крутой приз LEGO.

Применяются Условия и правила участия