



# CLASSIC

11022



3



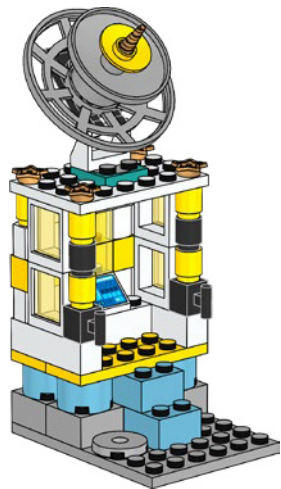
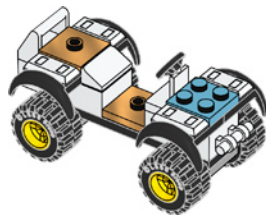
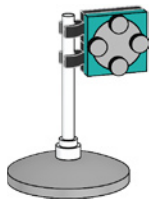
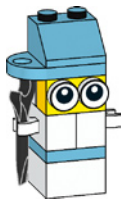





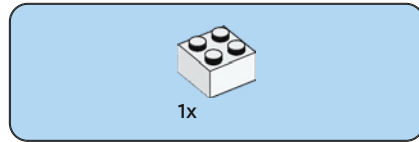

1

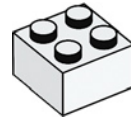
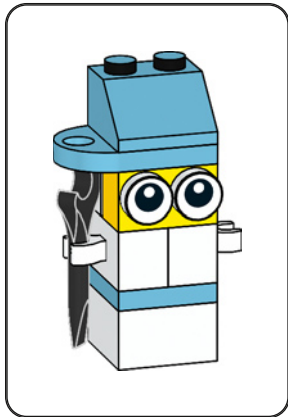



1x

2

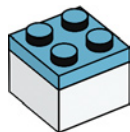

2x

3

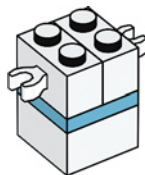



1x



1x

4

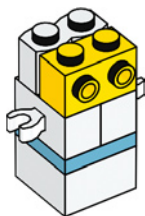

1x

5





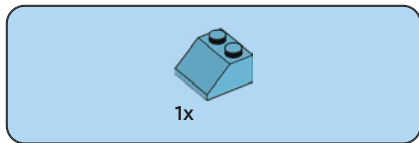

6

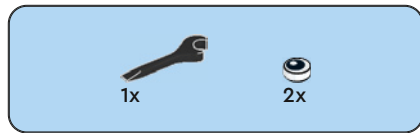

7

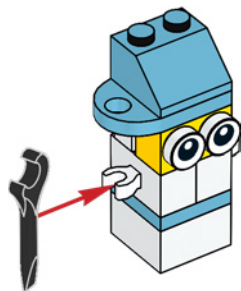

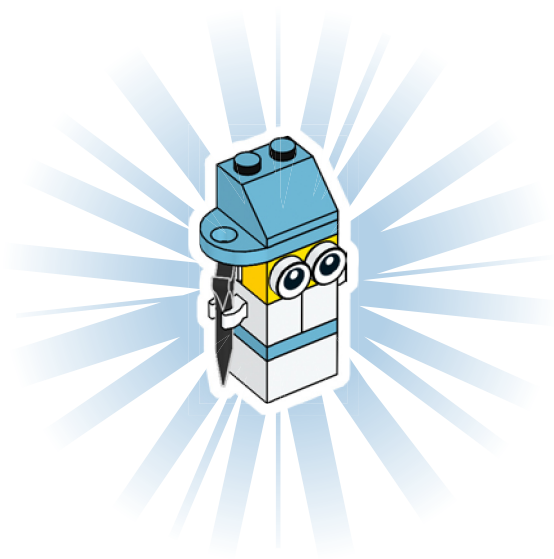

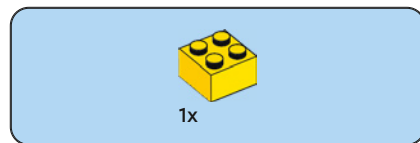
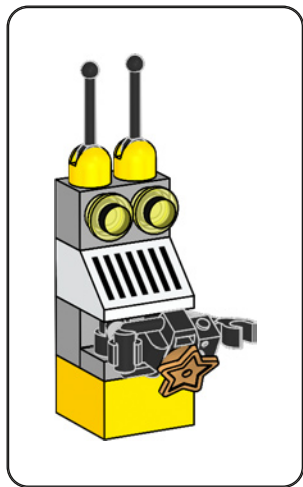

1

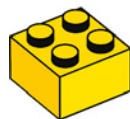



1x



1x

2

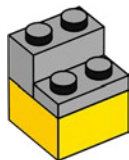

2x

3

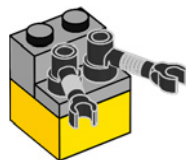



1x

4



1x

5

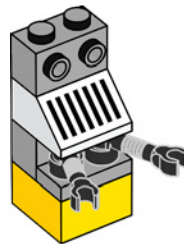



6

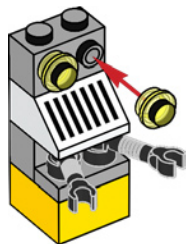

7

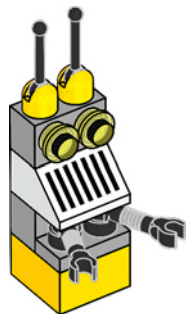



1x



1x

8

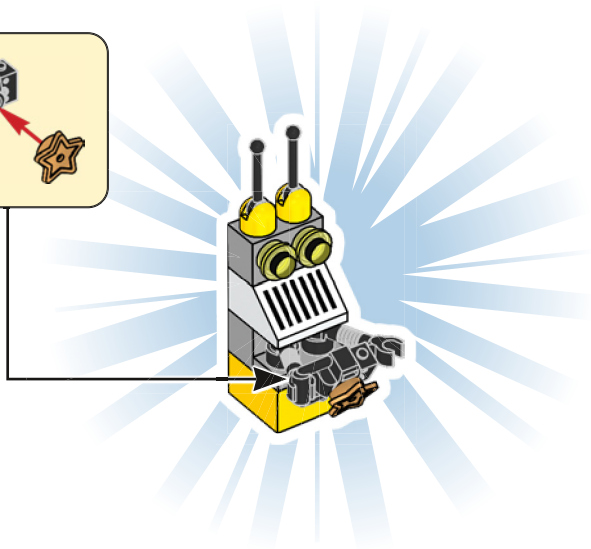
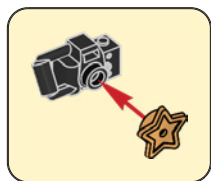

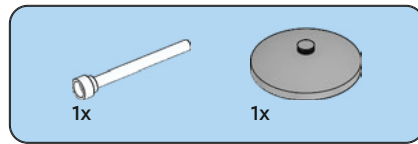

1

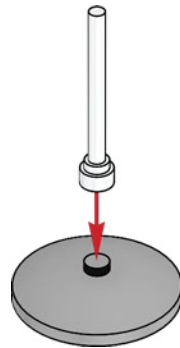
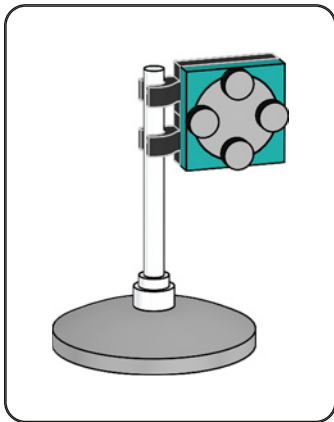



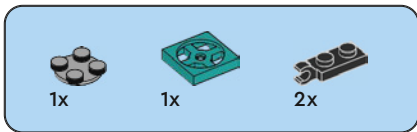

2

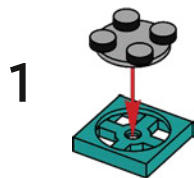

2

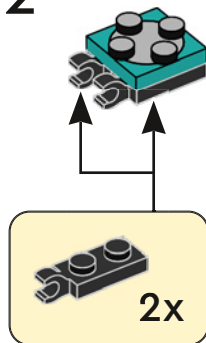

3

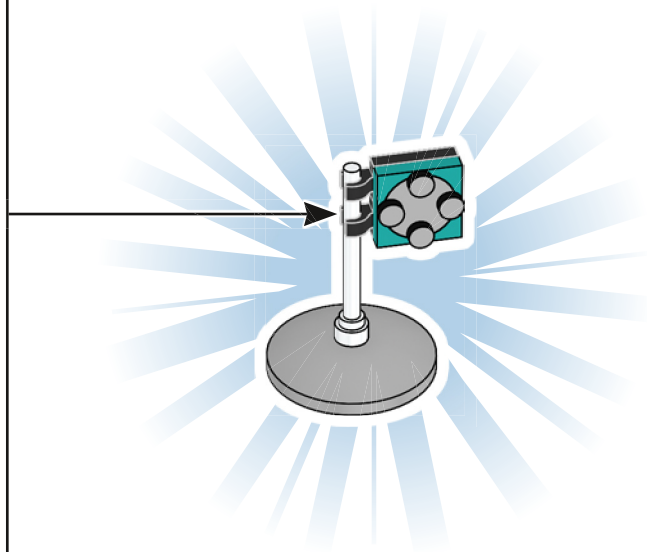

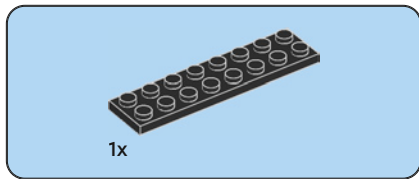
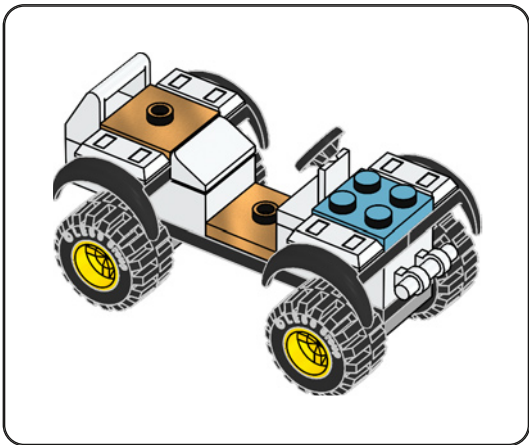

1

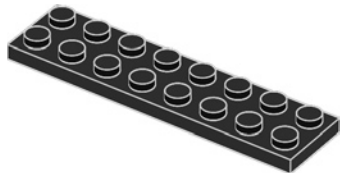



1x



1x

2

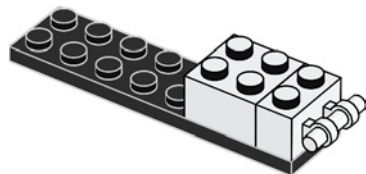

1x

3

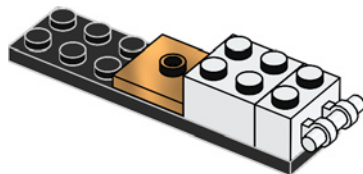



1x

4

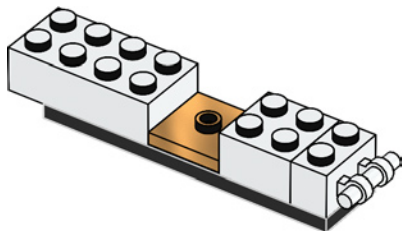

1x

5

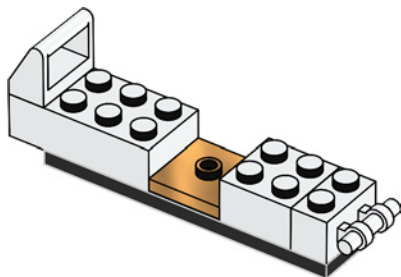

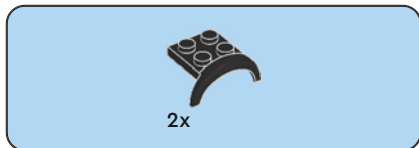

6

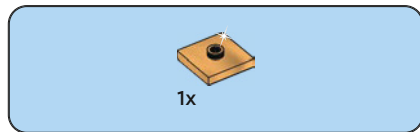
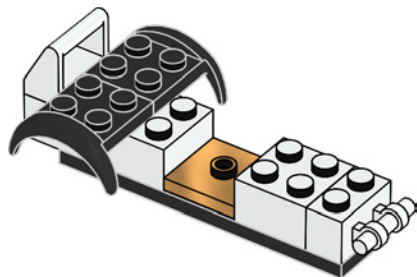

7

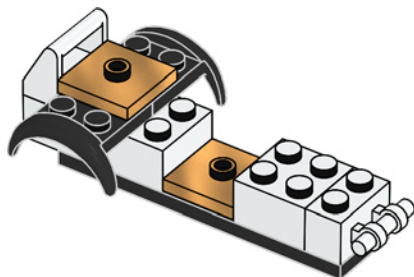



1x

8

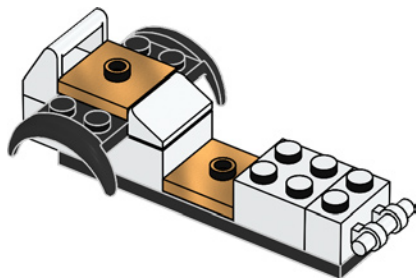

1x

9

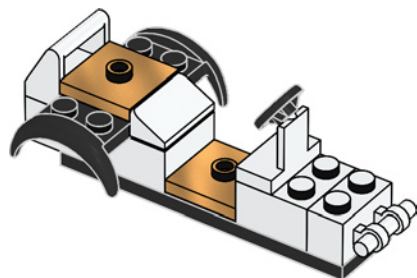



10

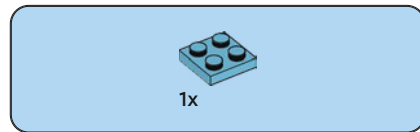
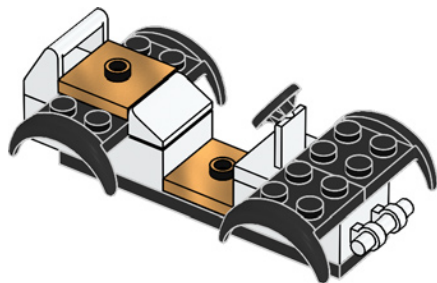

11

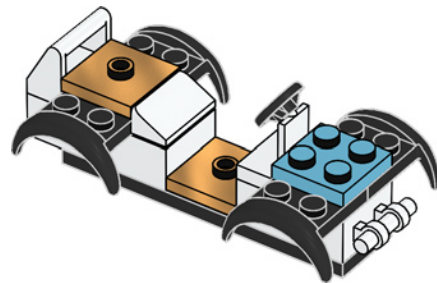



4x

12

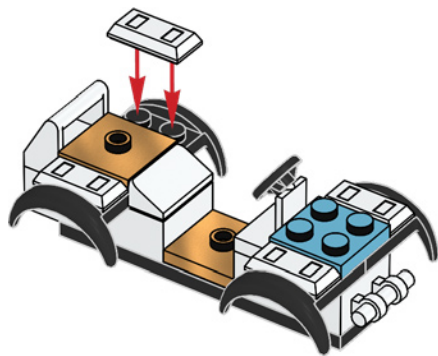





2x

# 13

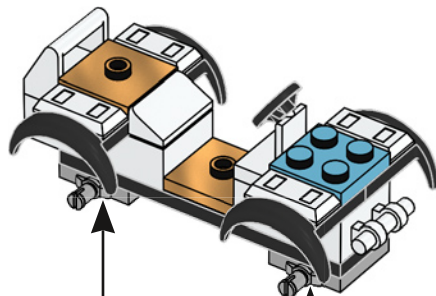

2x

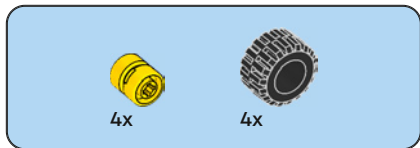

14

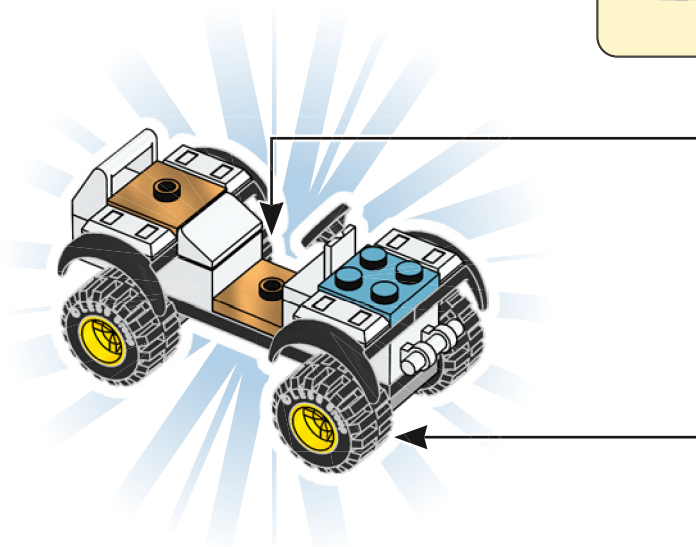
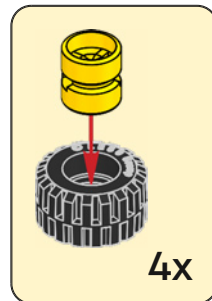

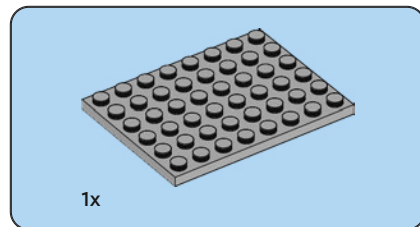
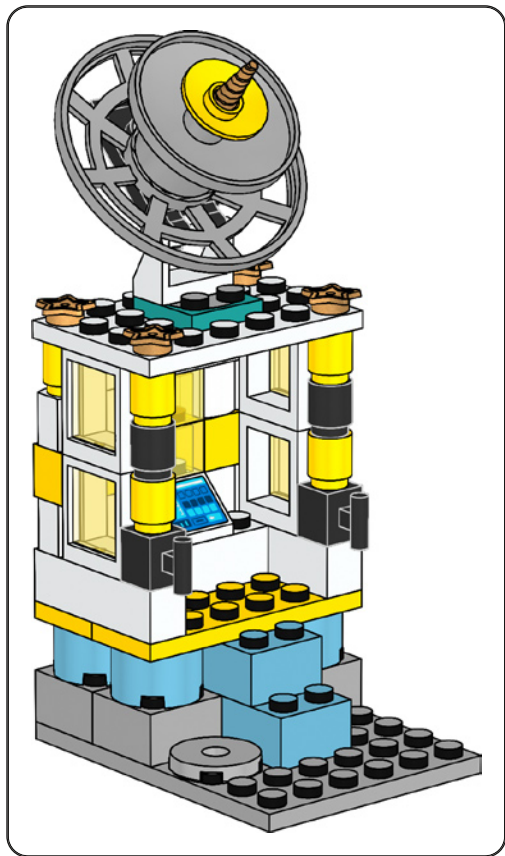

1

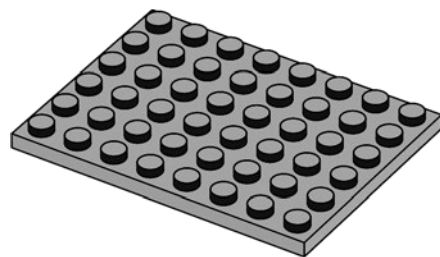

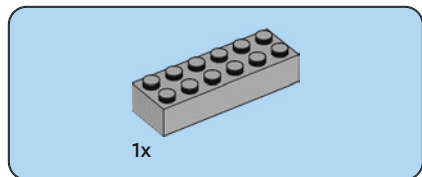

2

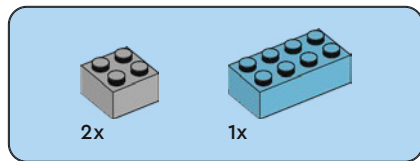
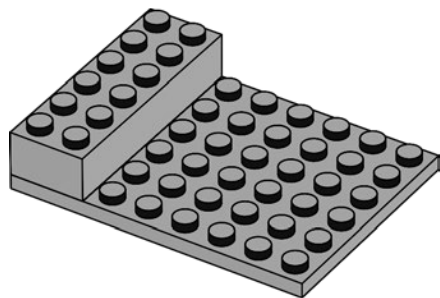

3

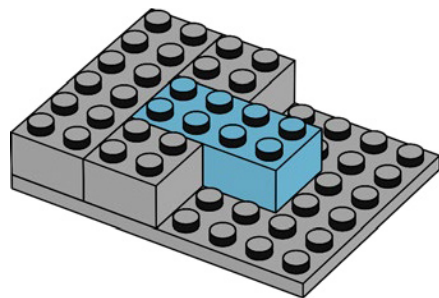

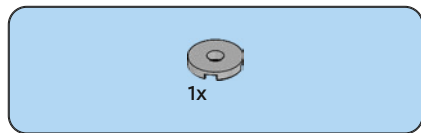

4

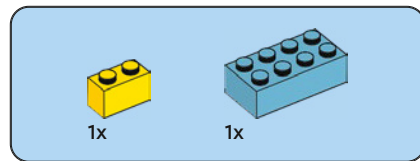
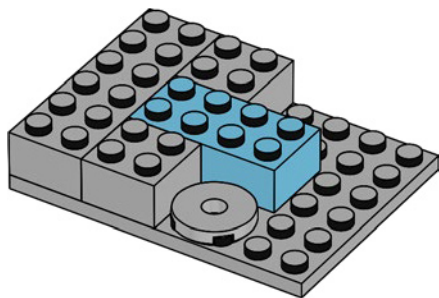

5

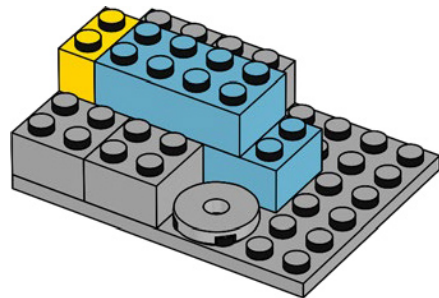



4x

6

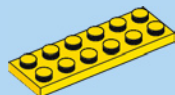
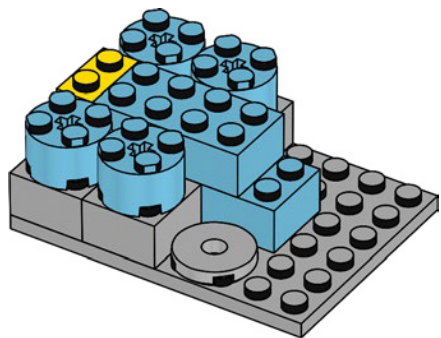

2x

7

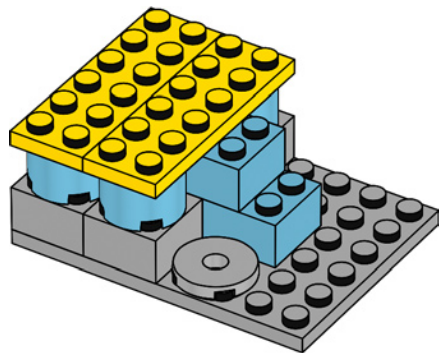

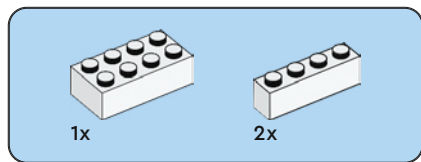

8

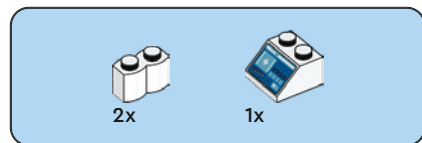
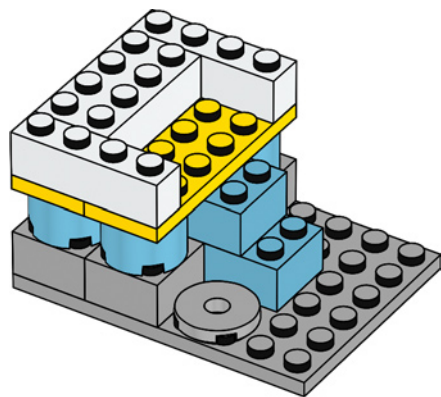

9

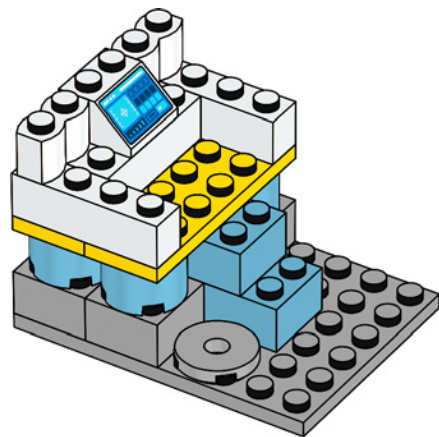



2x



1x

10

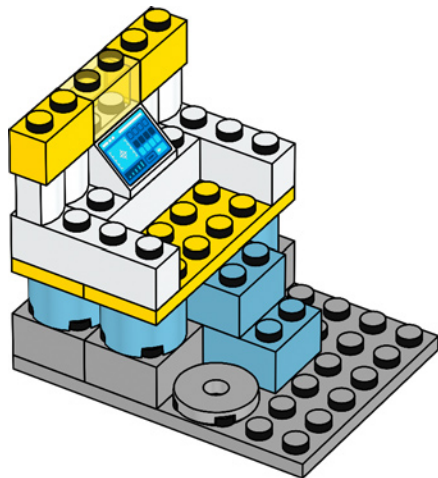



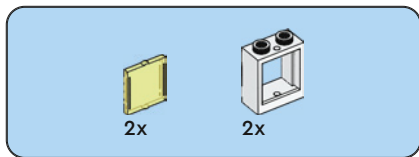

11

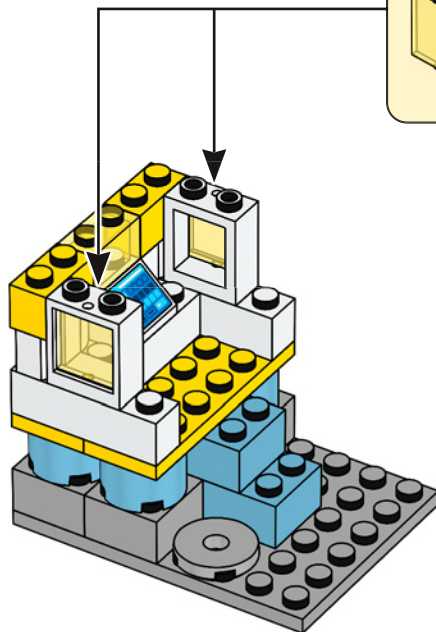
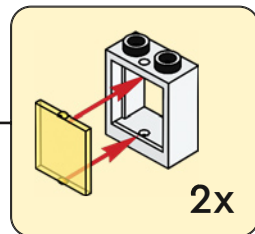



2x



2x

# 12

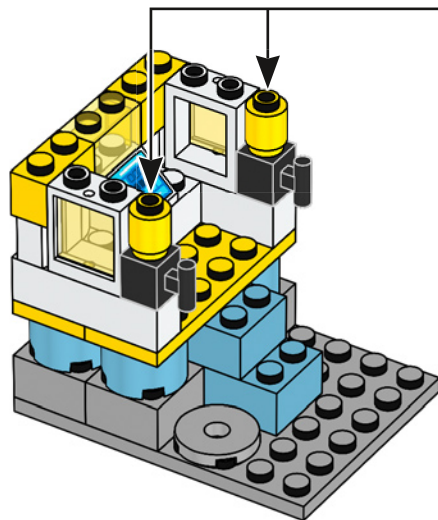

2x



2x



1x

13

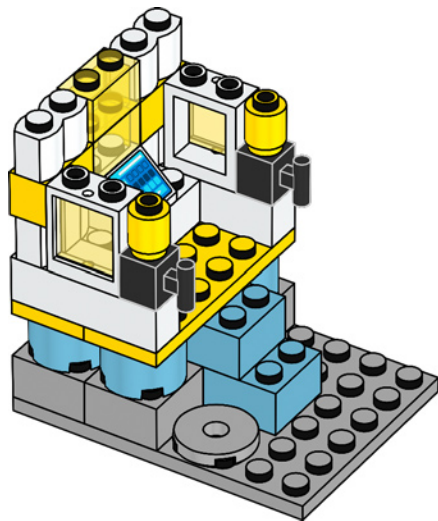

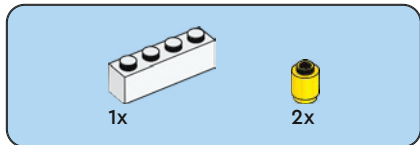

14

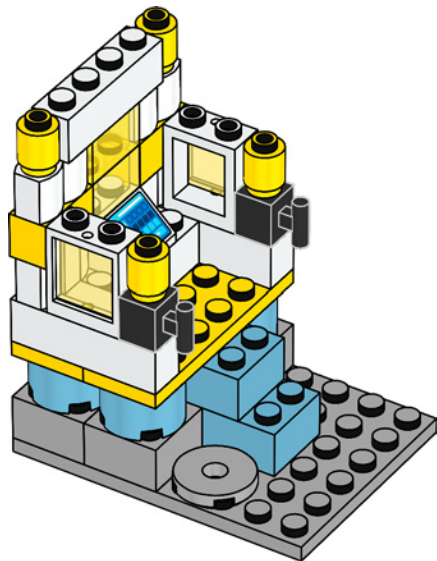

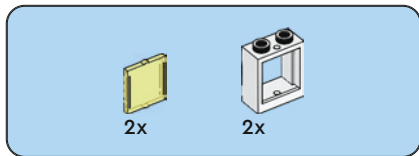

15

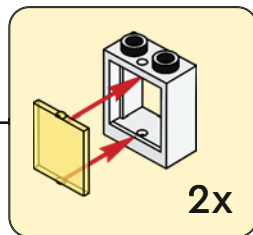
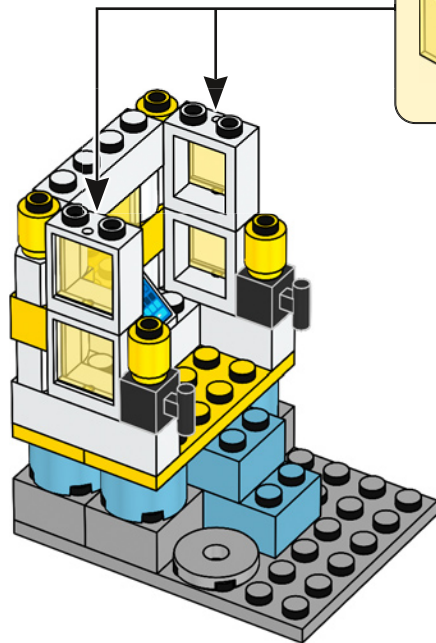



2x



2x



2x

16

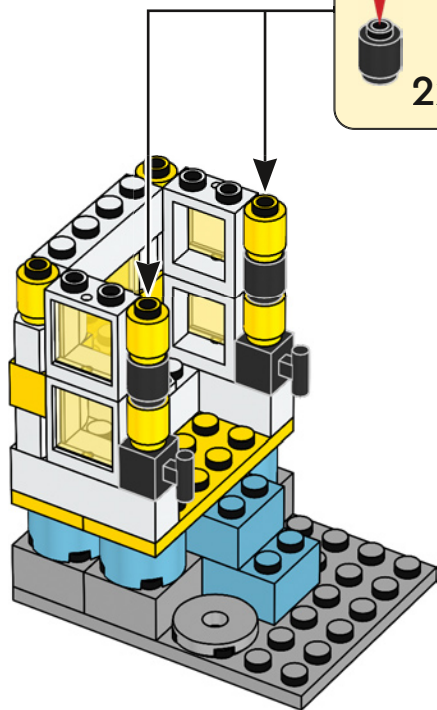

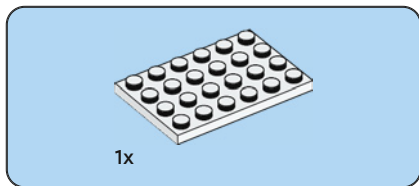

17

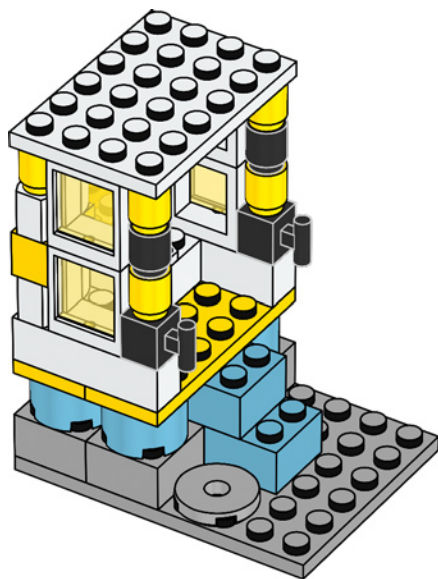



4x

18

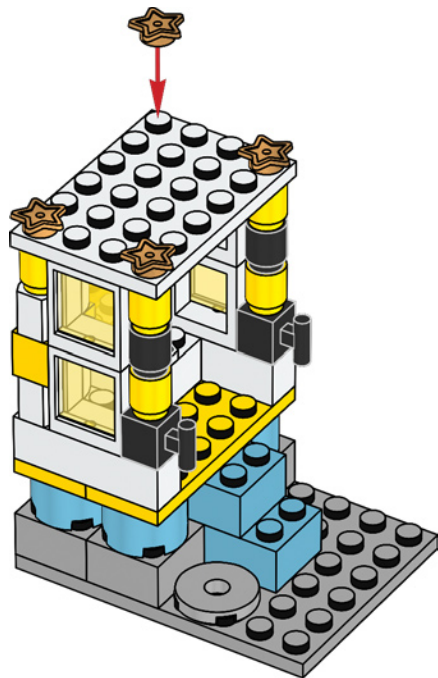



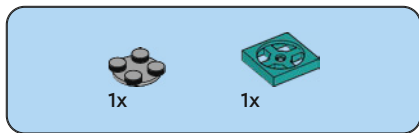

19

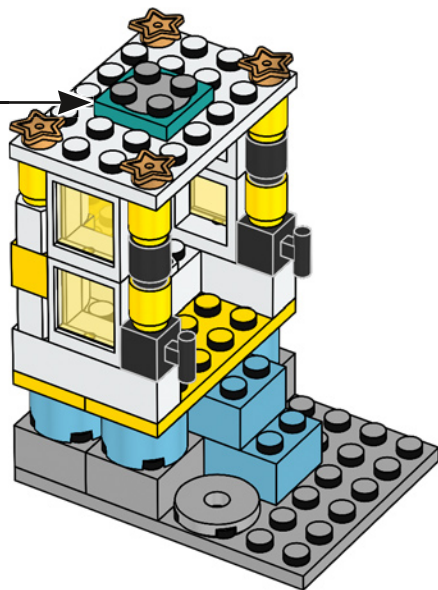
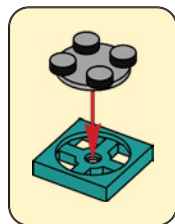



1x

20

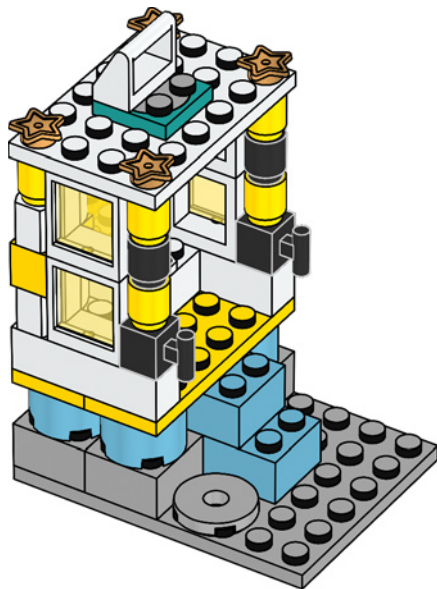

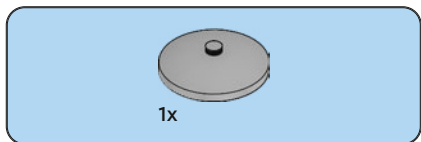
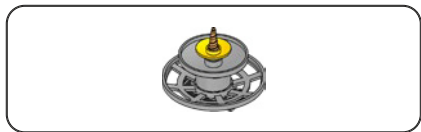

21

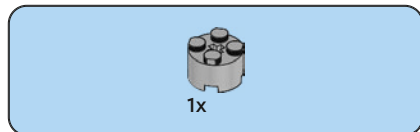
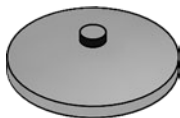

22

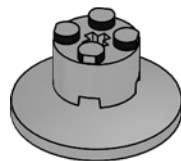

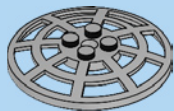

1x

23

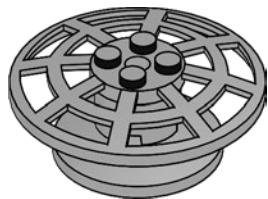

1x

24

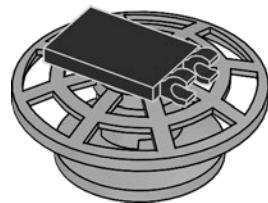

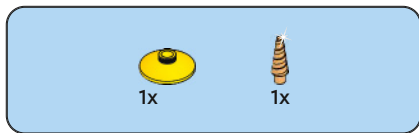

25

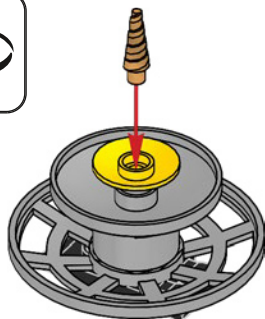

26

