

VIDEO COMPUTER SYSTEM

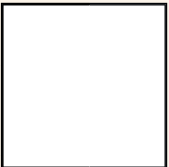

Booklet available in English on
Heft in deutscher Sprache erhältlich auf
Livret disponible en français sur
Libretto disponibile in italiano su
Folleto disponible en español en
如需中文版手册, 请访问



HAVE YOU BUILT ATARI® TODAY?

Unveiled in 1977, the ATARI® Video Computer System brought the realistic thrills of the arcade into the home and would go on to become one of the most popular gaming systems in history with 30 million units sold. This LEGO® version of the ATARI® Video Computer System is the iconic four-switch CX-2600A from 1980. It's full of authentic details and hidden gems that will take you back in time to the halcyon days of classic gaming. Enjoy.

THE GAMING ICON

As incredible as it sounds, the four-switch CX-2600A – the most popular version of the ATARI® Video Computer System – celebrates its 42nd anniversary in 2022. It set the standard for console gaming in its day and remains the starting point for all retro console design from ATARI® today.



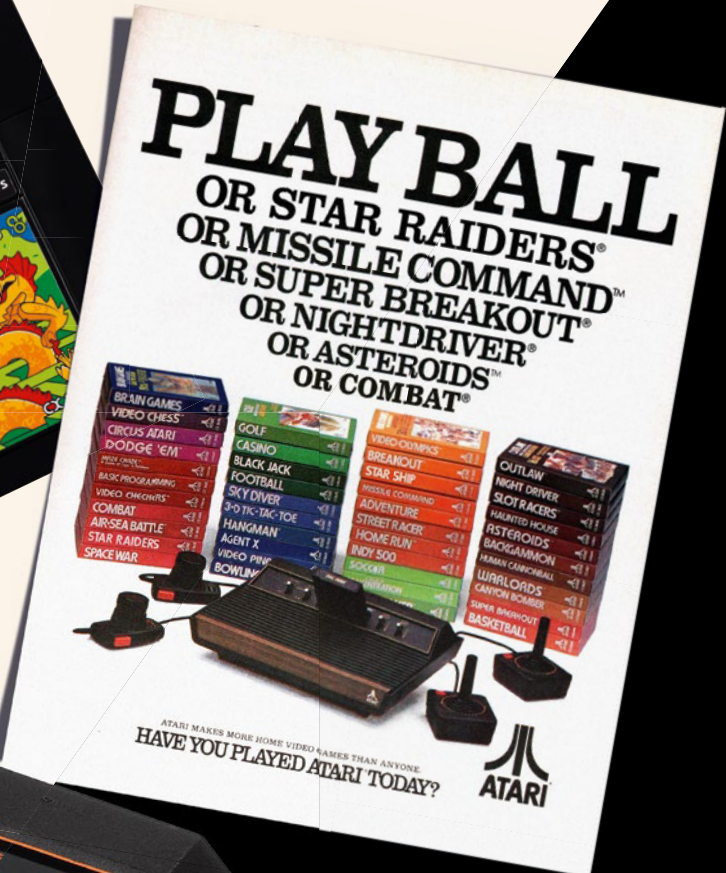

HAVE YOU PLAYED ATARI TODAY ?

ATARI 50



50 YEARS OF FUN

Founded in 1972 ATARI® remains one of the most iconic names in the gaming world, and more than half a century later the brand continues to resonate with fans and those looking for the thrill of vintage gaming. Namechecked widely in countless TV shows, movies and in pop culture, ATARI® has also become an authentic cultural reference point reaching far beyond its computer gaming origins.



← The cartridge system allowed players to immerse themselves in many different games

↓ Advertisement for the ATARI® Video Computer System

ATARI

THERE'S NO COMPARING IT WITH ANY OTHER VIDEO GAME.

Only ATARI makes the games the world wants most. Games that are innovative. Intense. Incredibly involving. And totally original.

The most games, the best games are only from ATARI. Atari makes more video game cartridges than anyone else.

Today ATARI Missile Command and Asteroids are the fastest selling home video games in the country.

| | |
|-----------------|---|
| NIGHT DRIVER | ▲ |
| SCOTTRACKERS | ▲ |
| ASTEROIDS | ▲ |
| BACKLASHMAN | ▲ |
| KIMMY CONCHBALL | ▲ |
| LURIELORDS | ▲ |
| CHUCKY DUMBER | ▲ |
| BASKETBALL | ▲ |
| RACE | ▲ |
| HOME RUN | ▲ |
| STREET RACER | ▲ |
| ADVENTURE | ▲ |
| MISSILE COMMAND | ▲ |
| BIRLACROT | ▲ |
| VIDEO CHESS | ▲ |
| CONCENTRATION | ▲ |
| CODEBREAKER | ▲ |
| GOLE | ▲ |
| CASINO | ▲ |
| BLACKJACK | ▲ |
| FOOTBALL | ▲ |
| SKY DIVER | ▲ |
| SPORTING VIDE | ▲ |
| HANKAMAN | ▲ |
| BRJAN GAMES | ▲ |
| VIDEO PINBALL | ▲ |
| AGENT X | ▲ |
| BOWLING | ▲ |
| VIDEO CHESS | ▲ |
| CIRCLE TARGET | ▲ |
| DODGE 'EM | ▲ |
| WHEEL ORDE | ▲ |
| VIDEO CHECKMATE | ▲ |
| ARCADE BATTLE | ▲ |
| COMBAT | ▲ |
| STAR WARRIOR | ▲ |



MORE GAMES. MORE FUN.

Unlike many earlier gaming systems that only offered a single integrated game, ATARI® used a cartridge system that allowed a virtually limitless selection of games. A total of 527 games would be published for the ATARI® Video Computer System and hits such as *Asteroids*, *Ms. Pac-Man*, and *Pitfall* established it as the must-have gaming system in the late '70s and early '80s.



1980 **ADVENTURE**

In a game that would inspire a whole generation of quest adventures, the wicked wizard has stolen your castle's magical chalice and you must lead your brave knight through terrible dangers to ensure its safe return!

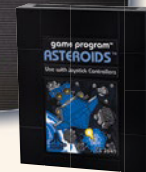

1981 **ASTEROIDS**

The highly addictive object of this game is to gain the highest score by shooting down waves of asteroids, satellites and UFOs. Once shot, the asteroids break into smaller, faster pieces that fly off in unpredictable directions!



1982 **CENTIPEDE**

Use the wand at the bottom of the screen to destroy as many bugs as you can. Your nemesis is a long and winding centipede that invades each level. To proceed in the game, you must exterminate each segment of the centipede in every level!

BUILDING AN ICON

This 2,532-piece LEGO® model is a close 1:1 representation of the iconic four-switch Atari® Video Computer System (Model CX-2600A). As well as a replica joystick that plugs into the back of the console, it also has four functioning switches on the front. Three

cartridges of famous VCS games are included, and each game is represented by a buildable LEGO vignette visualising the gaming experience offered. All the games can be stored in a cool '80s-style cartridge holder when not in use!



FRONT PANEL



BACK PANEL

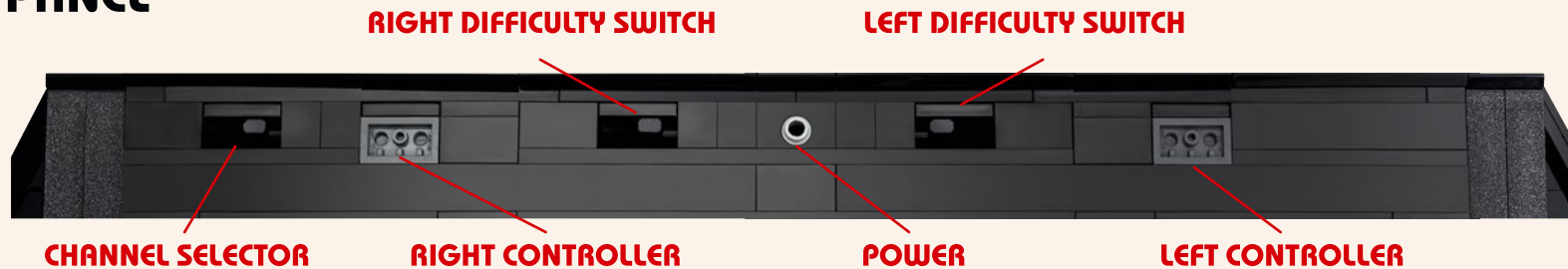

THE ATARI® VIDEO COMPUTER SYSTEM

There were various versions of the ATARI® Video Computer System launched between 1977 and 1992, mostly differentiated by weight, number of switches or the finish of the console itself. The technology, while impressive

in its day seems inconceivable today, with a limited processor speed of 1.19 MHz, a total capacity of 128 bytes of onboard RAM and a game cartridge capacity of only 4 kilobytes!

FROM THE DESIGN TEAM

As an avid fan of classic console gaming and a proud owner of an original ATARI® Video Computer System, working on this project in time for ATARI's 50th anniversary was a dream come true! Once we decided on the overall scale and features of the model, it was all about getting the little details just right: designing switches that can be toggled up and down, building a joystick that both looks and

feels like the original and creating a brick-built version of the classic woodgrain for the front of the console. Of course, we couldn't recreate the actual games themselves, but we decided to include three buildable vignettes to bring fans closer to the gameplay experience of these classic games.

LEGO® Designer, Chris McVeigh



The hidden pop-up scene is full of details that will feel instantly recognisable to anyone who grew up playing video games in the '80s



ATARI

ENTERTAINMENT
INDUSTRIES
BERKELEY, CA

CENTIPEDE

ADVENTURE

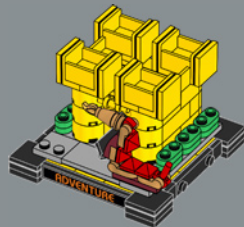
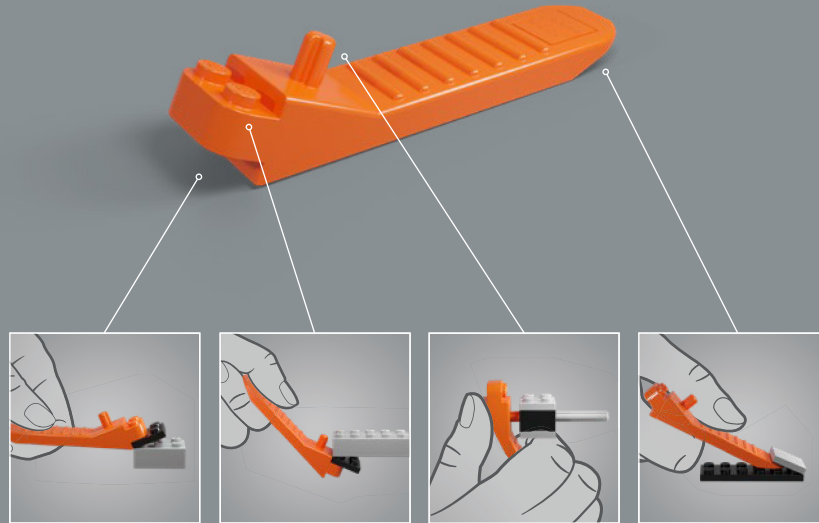

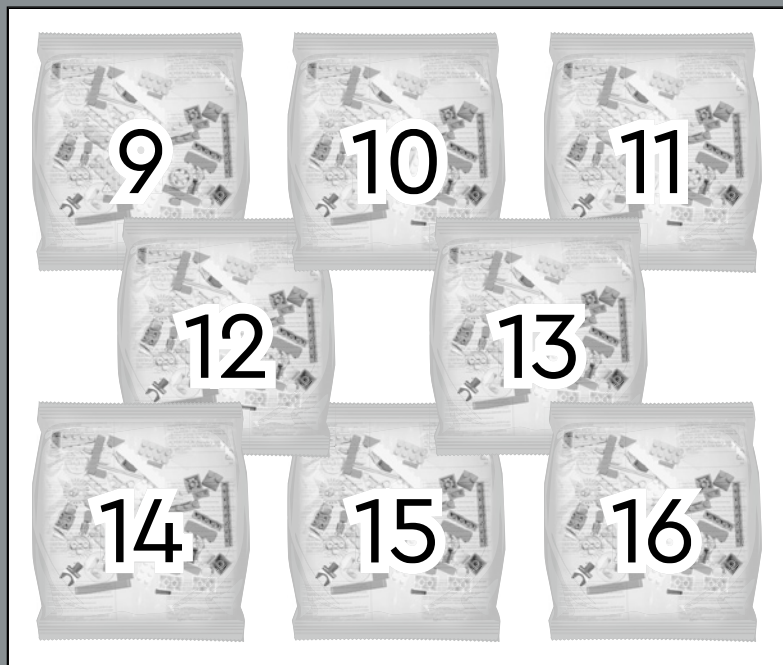
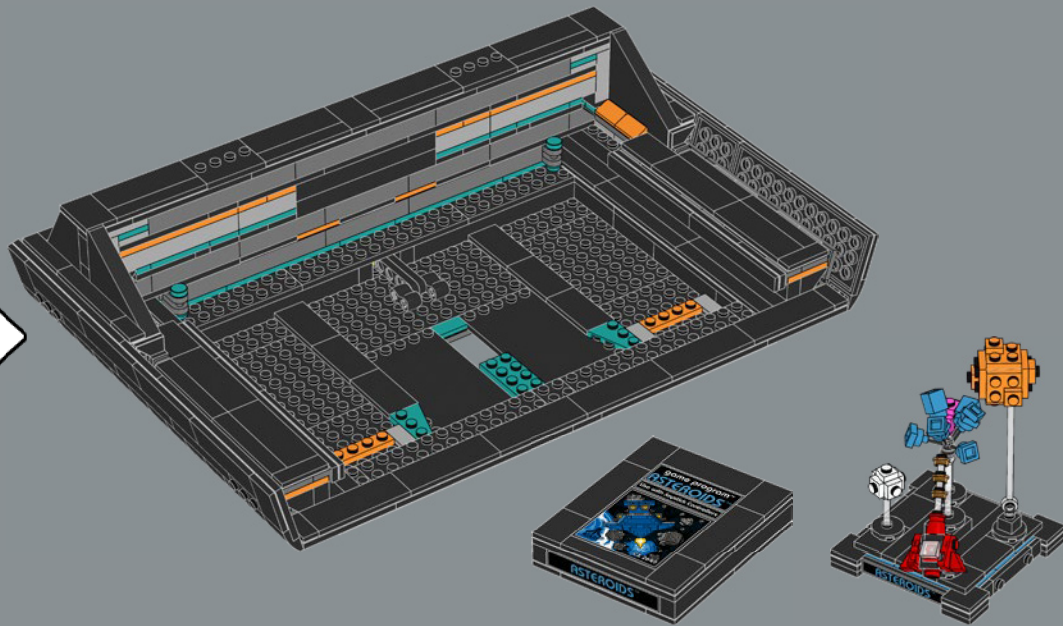

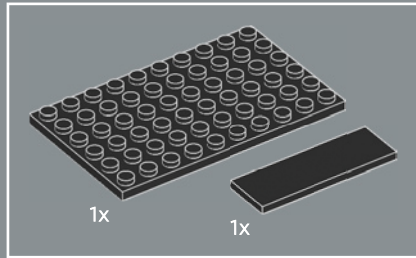
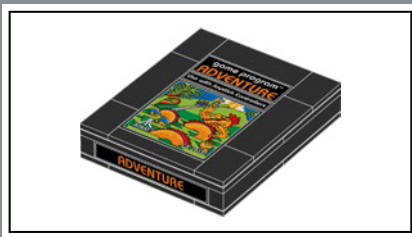

1

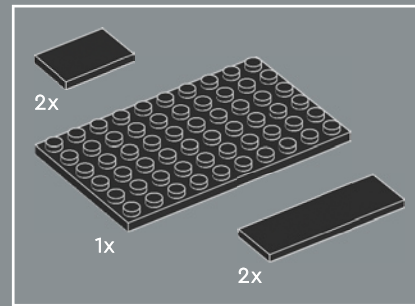
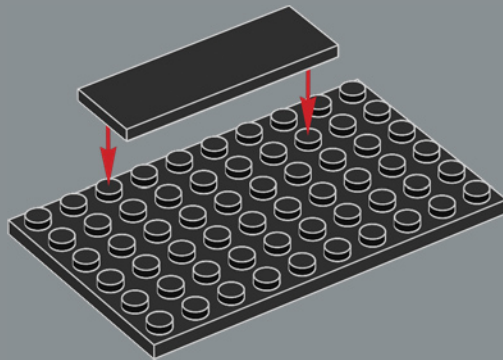

2

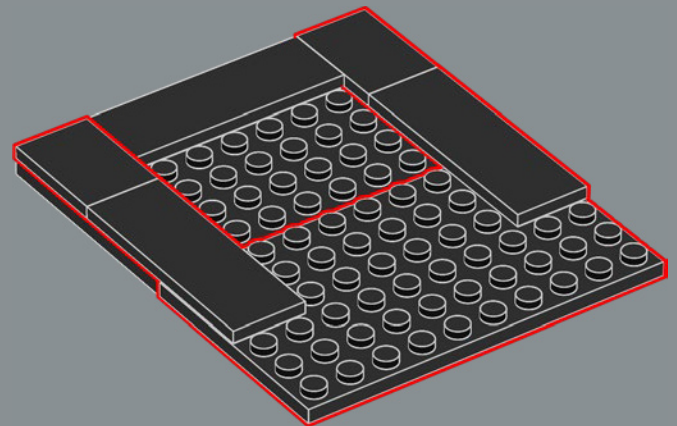

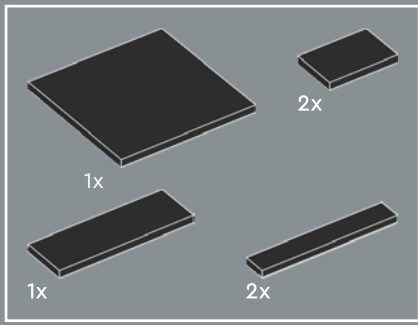

3

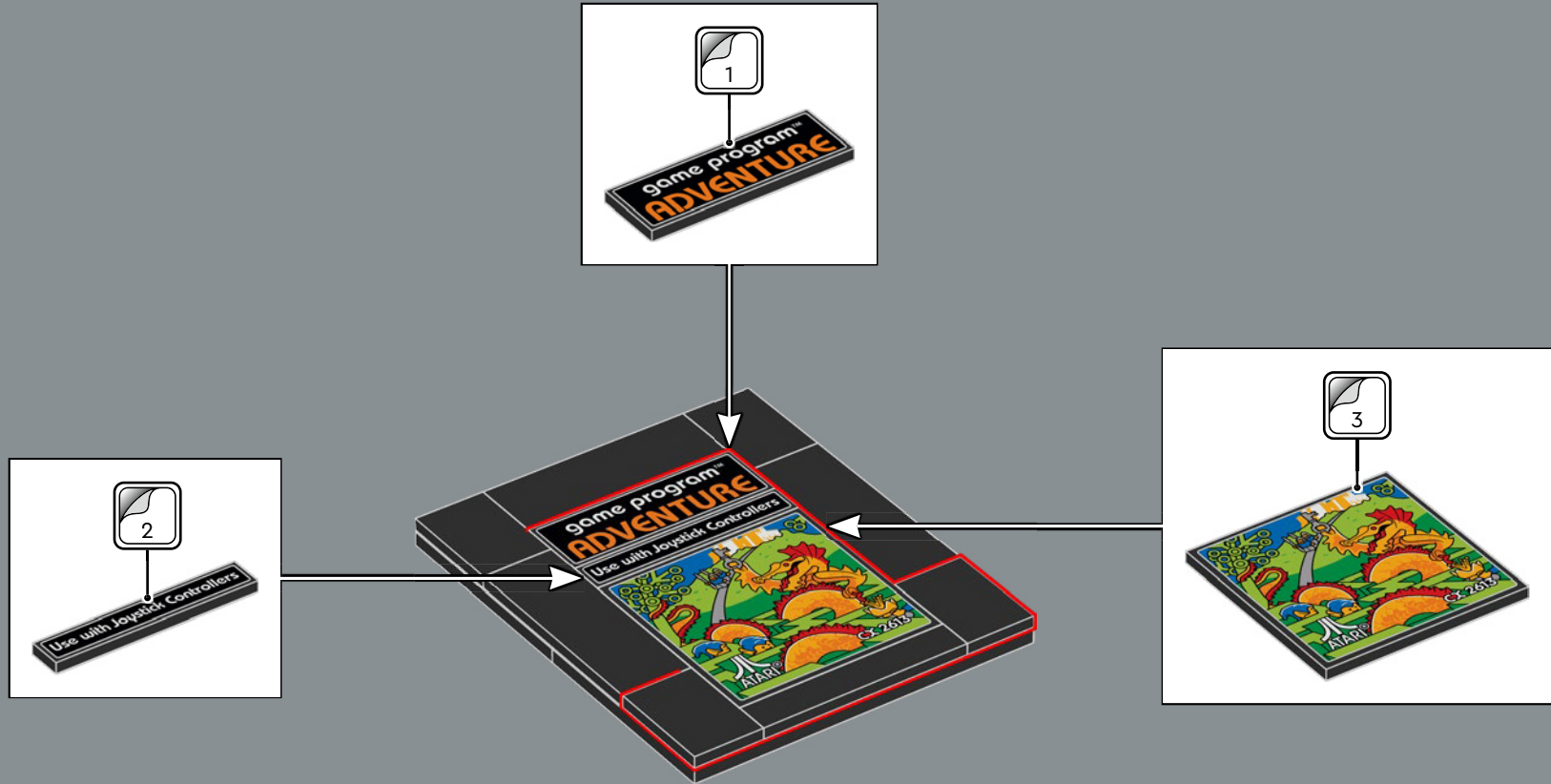

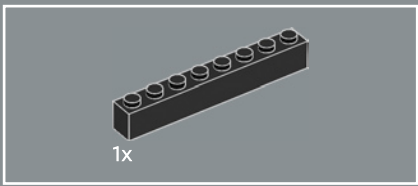

4

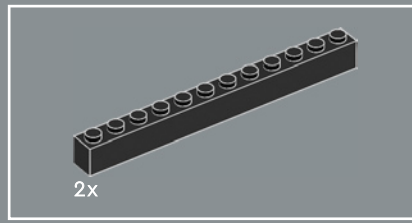
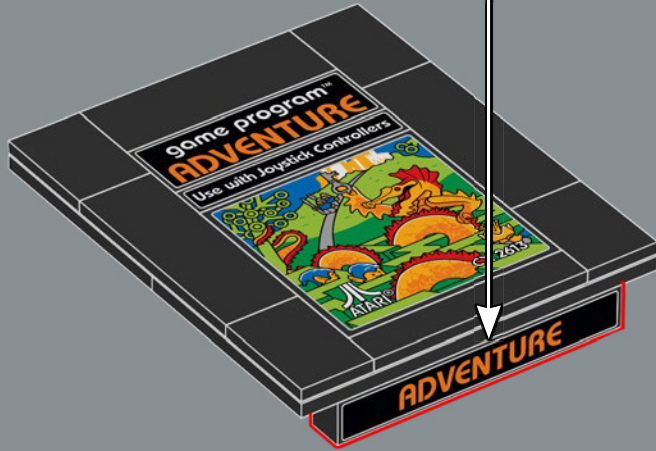
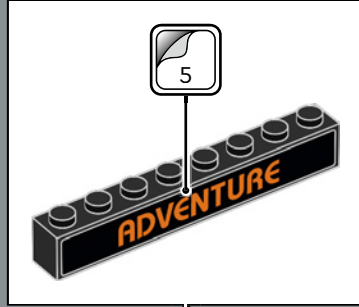

5

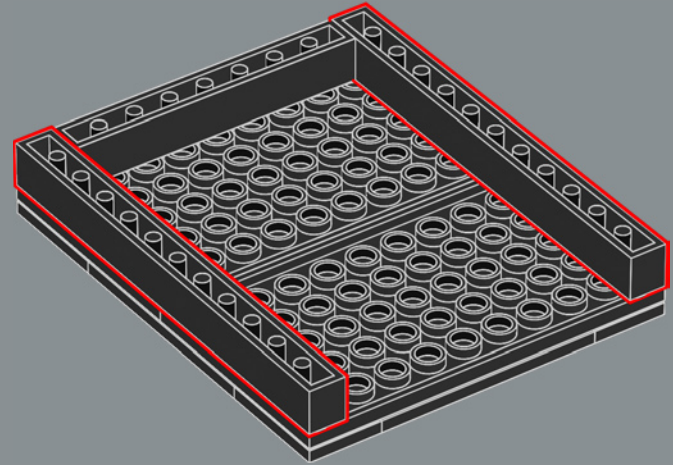

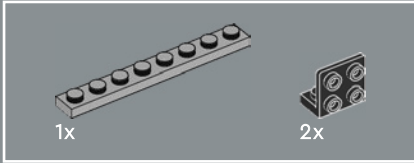
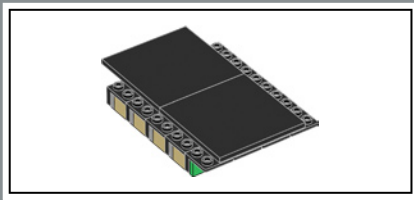

6

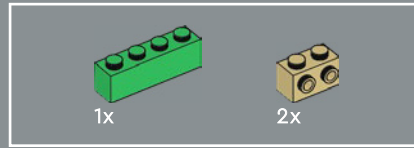
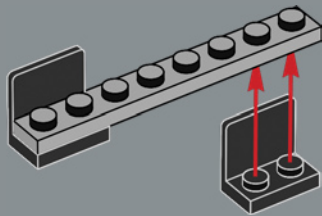

7

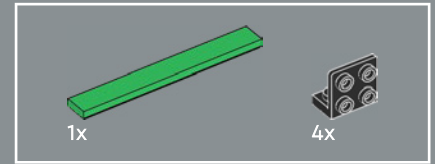
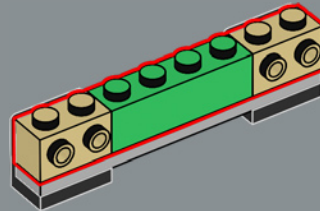

8

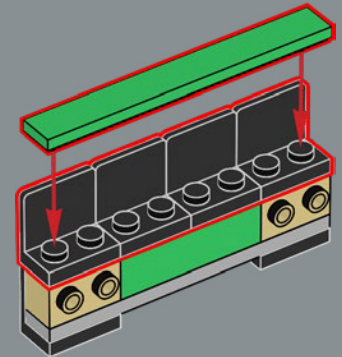

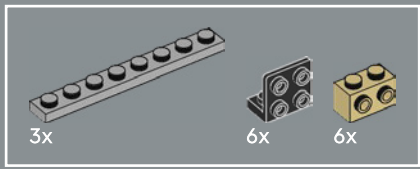

9

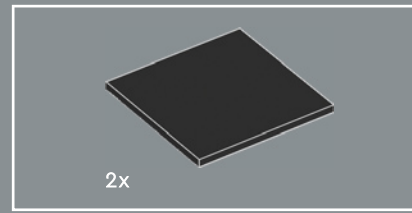
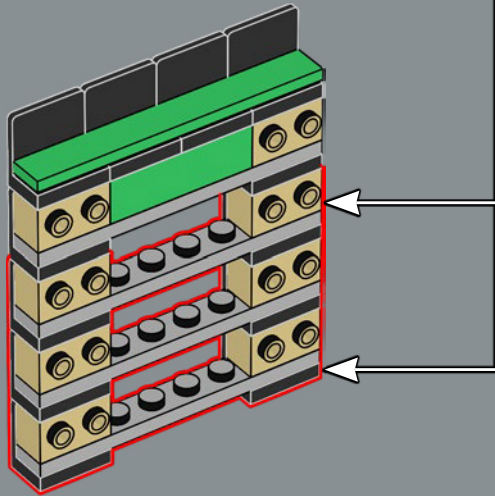
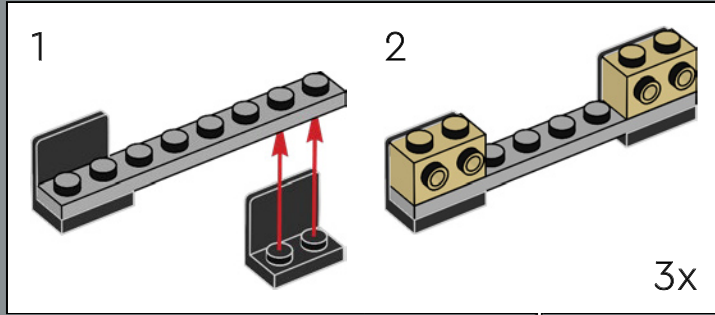

10

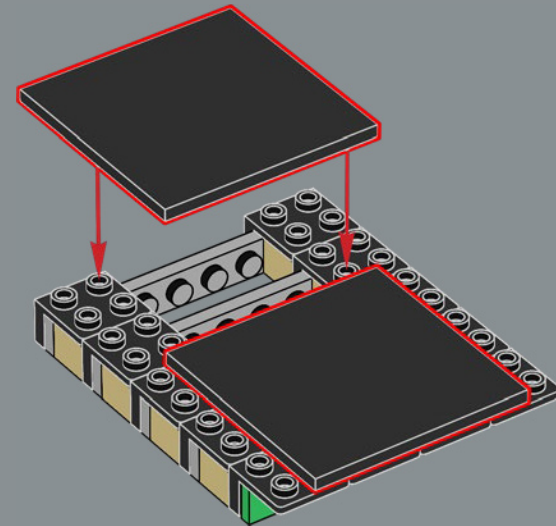

Many of the first ATARI® Video Computer System game cartridges used just 2k of data. That's roughly equivalent to a single page of text.



11

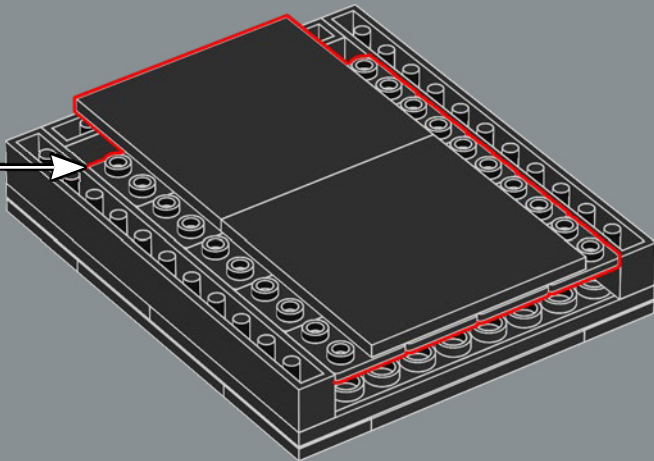

12

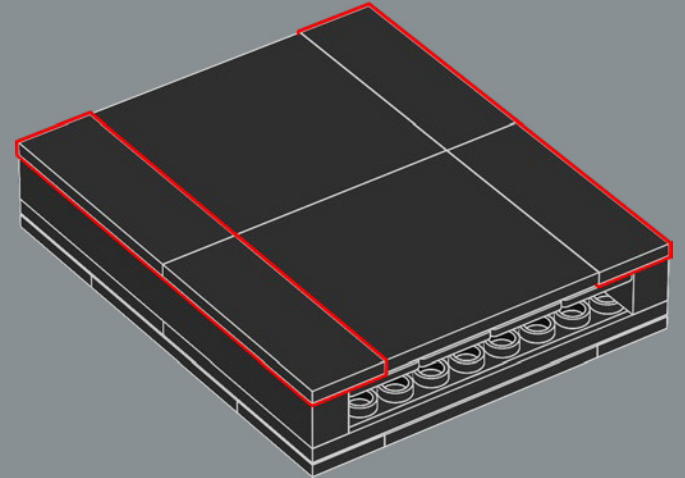
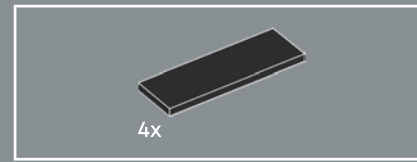

13



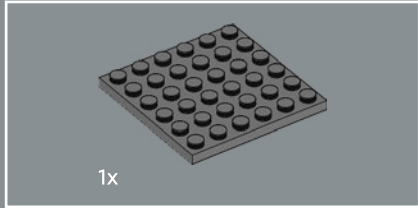
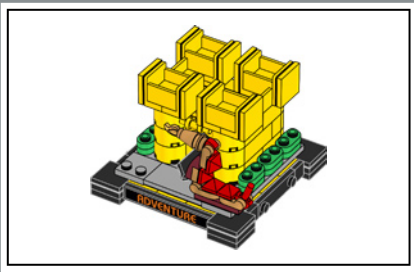

1x

1

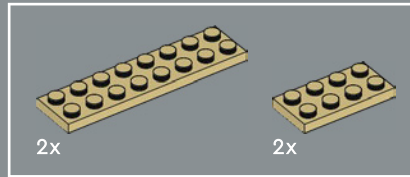
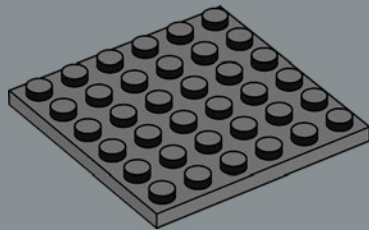

2x

2x

2

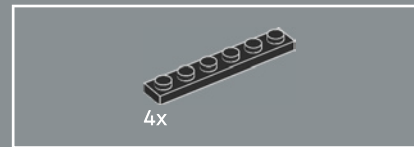
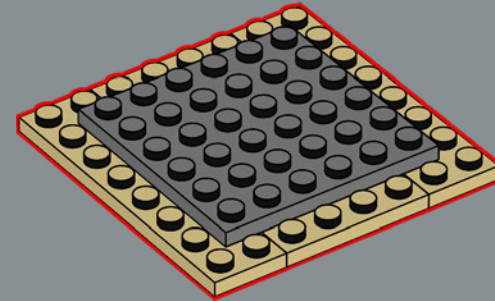

4x

3

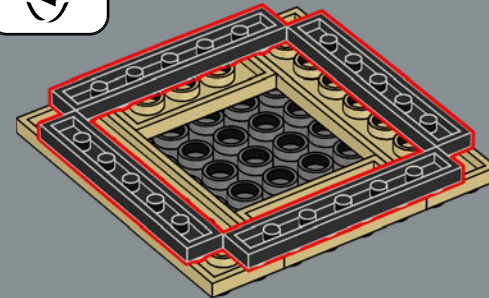

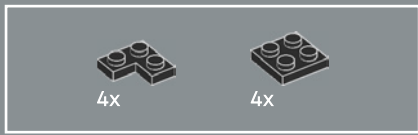

4

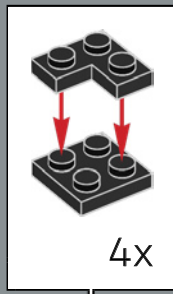
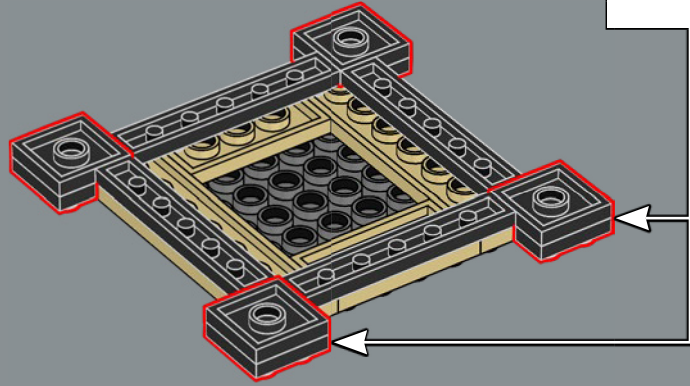

4x

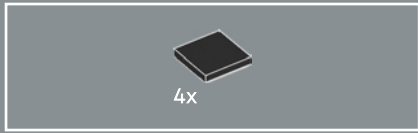

5

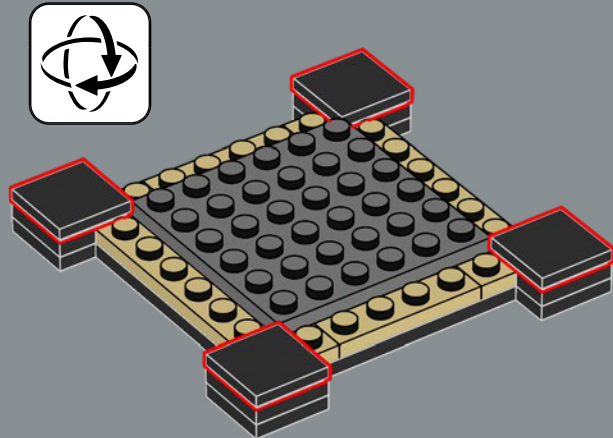

6

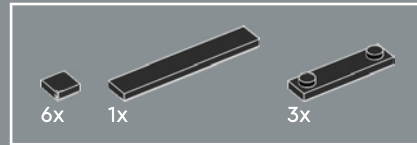
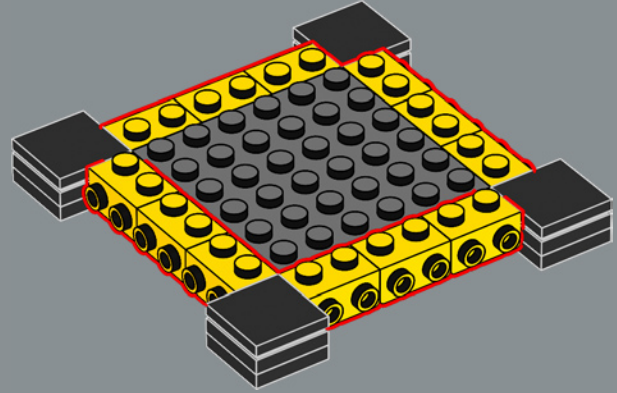

7

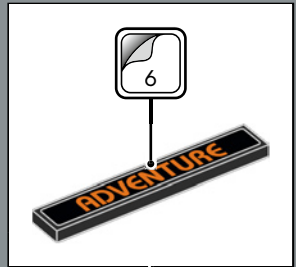
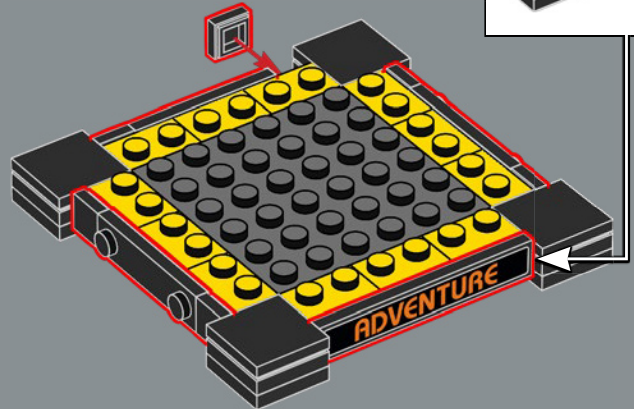

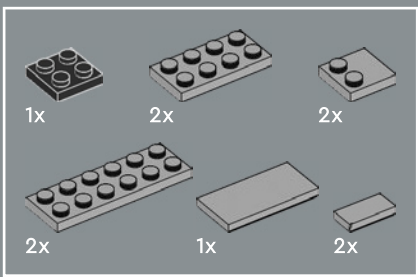

8

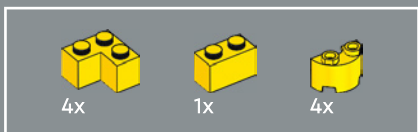
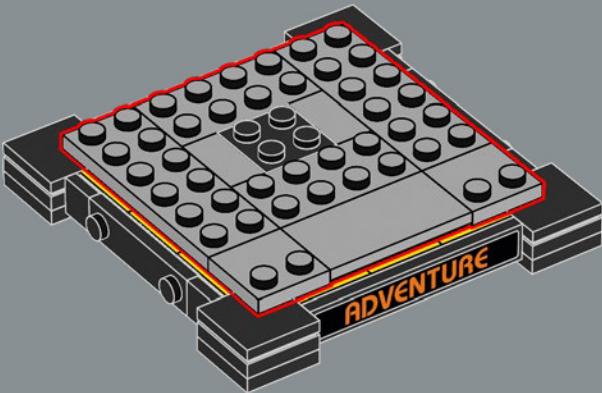

9

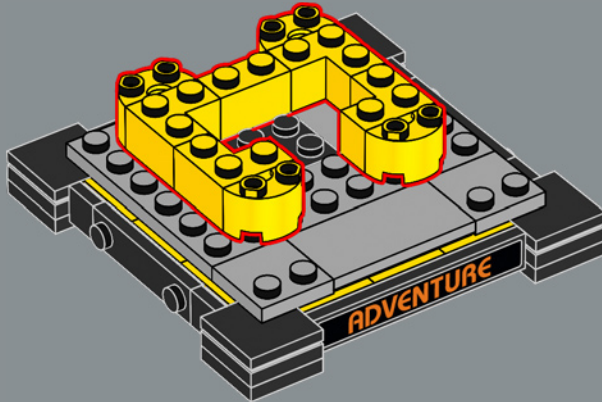

10

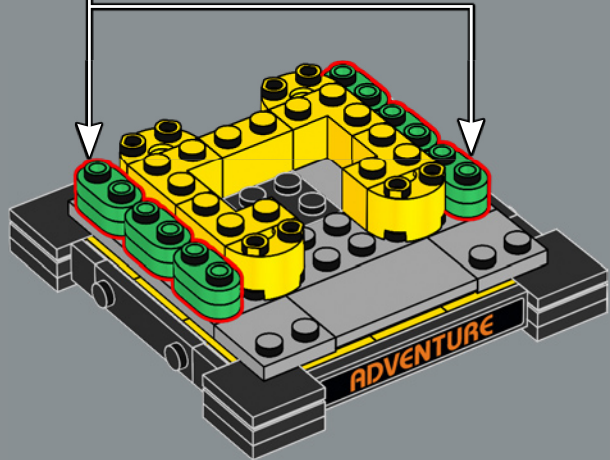
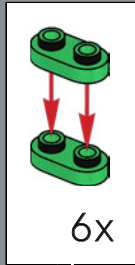



11

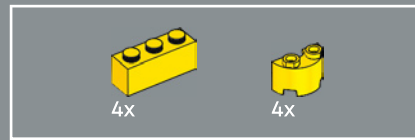
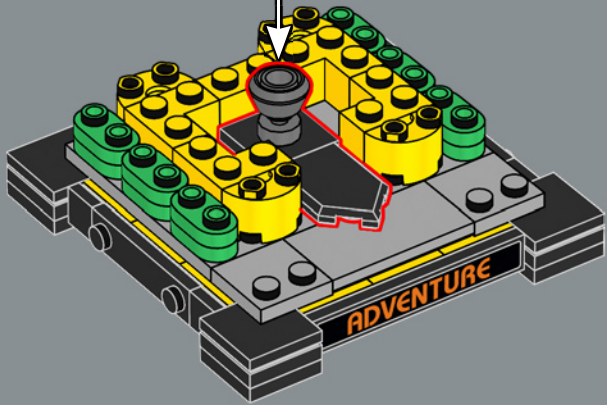
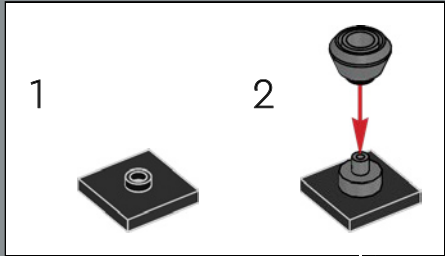

12

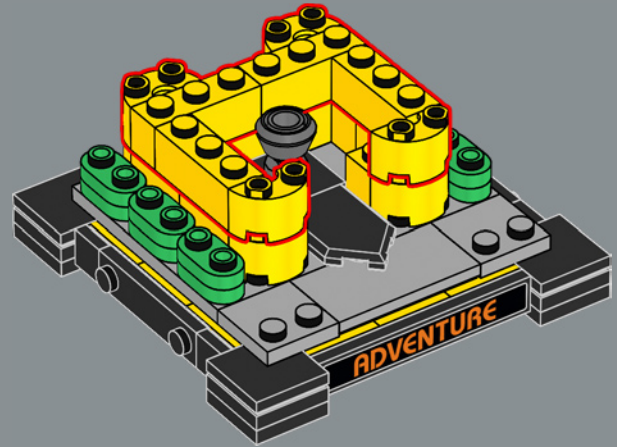

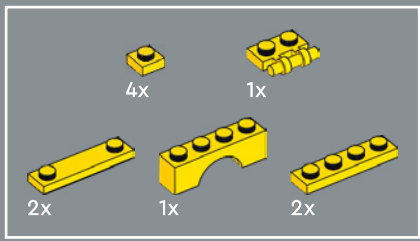

13

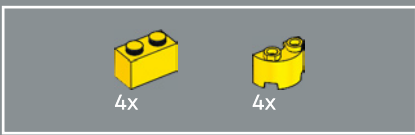
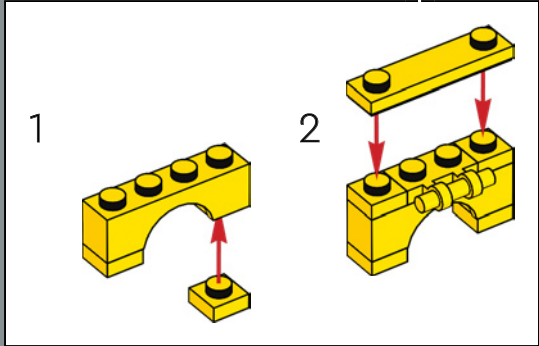
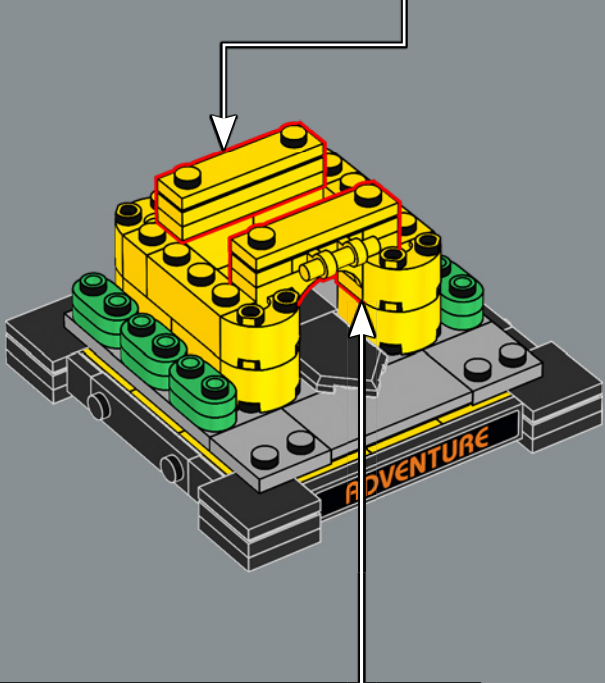
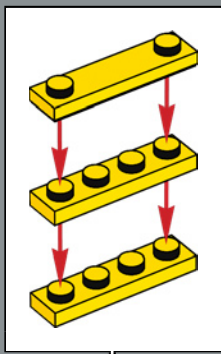

14

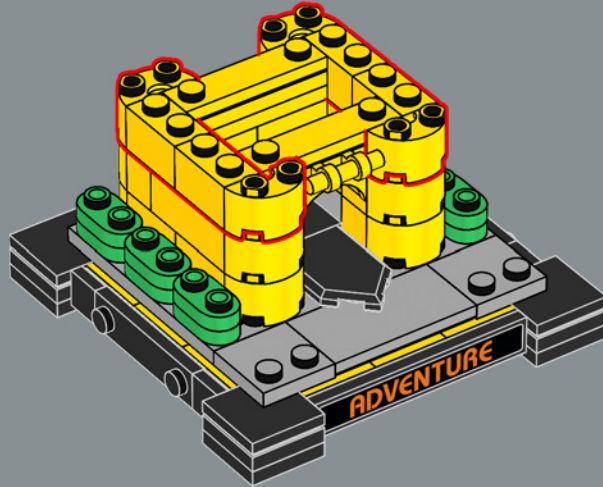

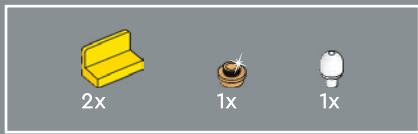

15

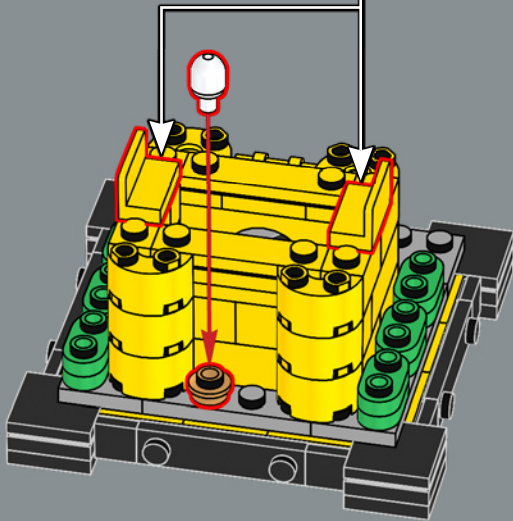
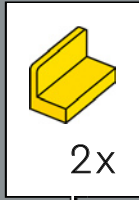

The Adventure vignette includes a small nest with egg at the back of the castle. This is a nod to the fact that Adventure features the first-ever Easter egg in a video game.

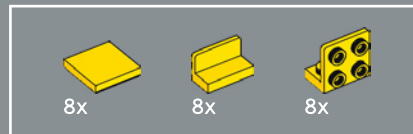

16

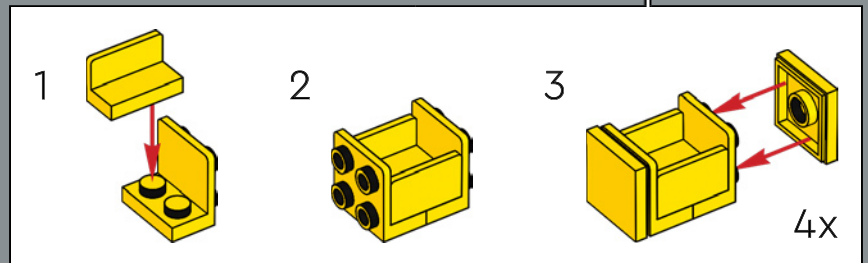
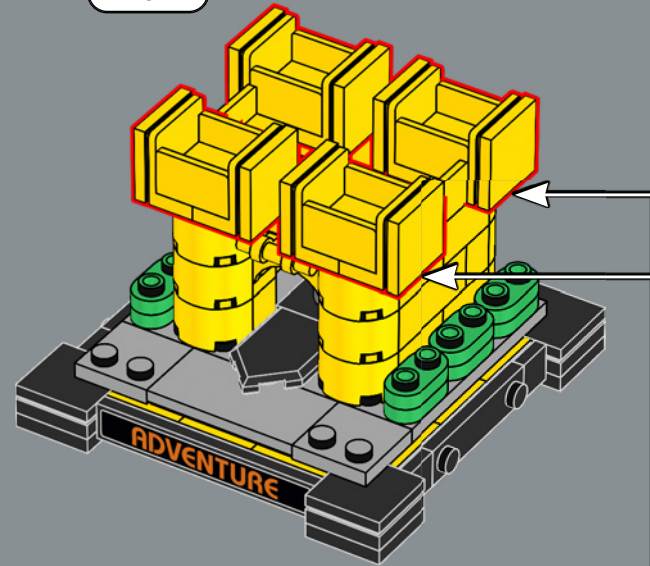

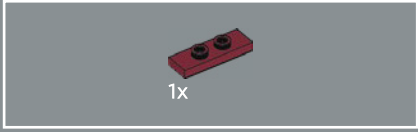

17

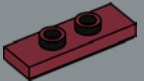

18

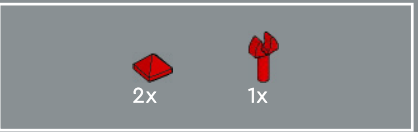

19



20

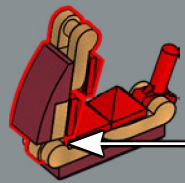
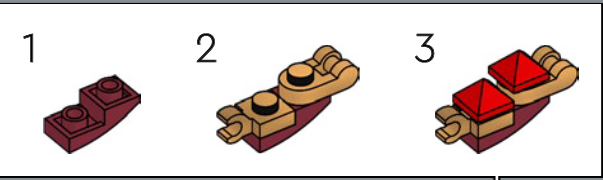



21

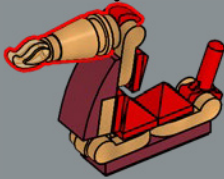
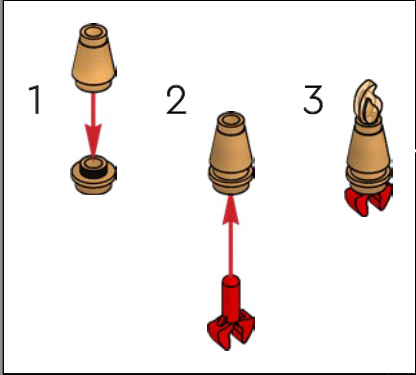

22

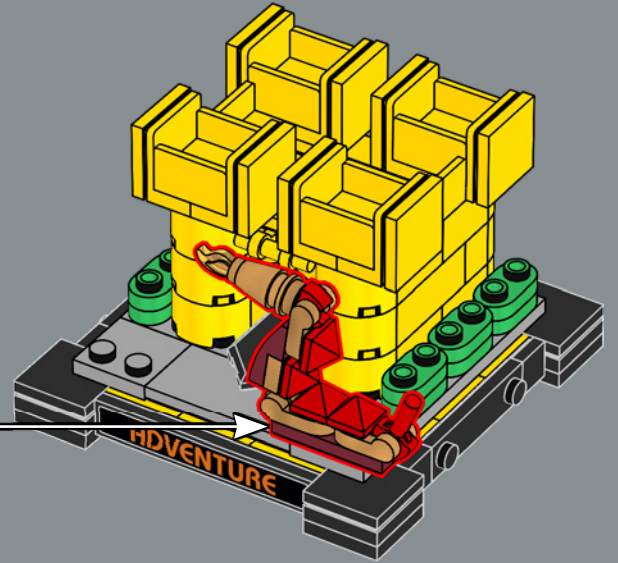

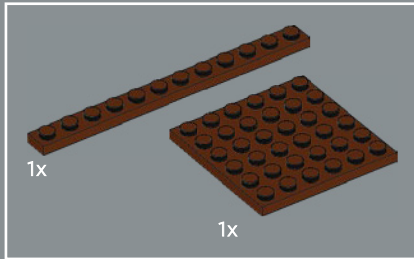
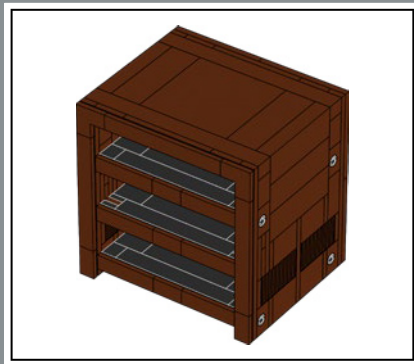

1

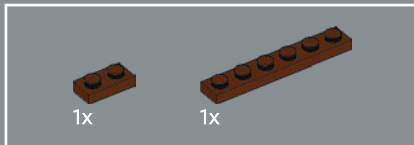
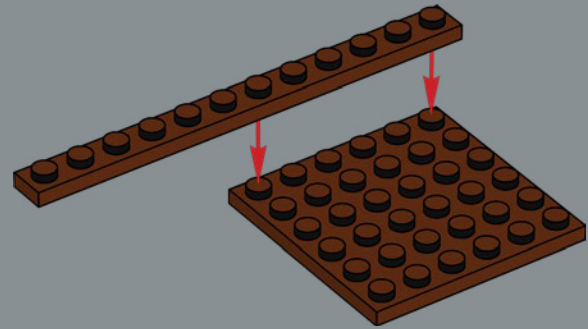

2

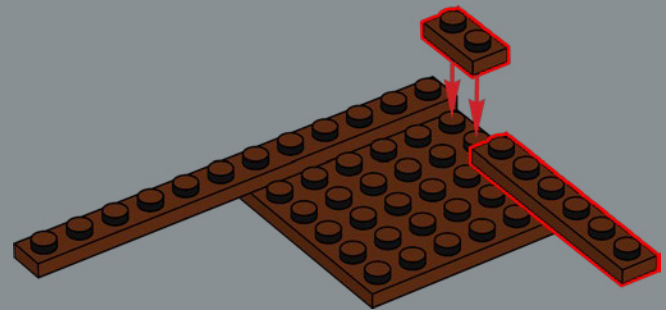

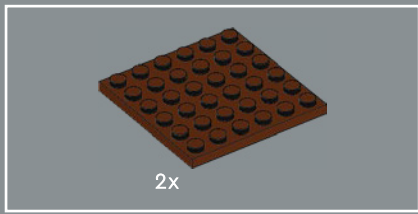

3

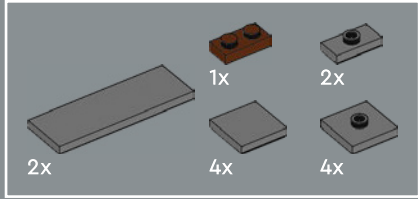
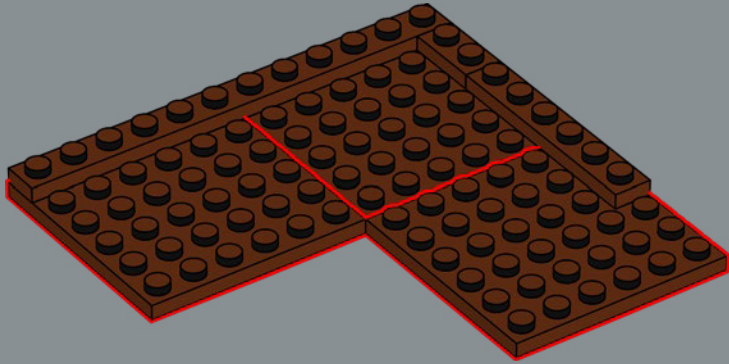

4

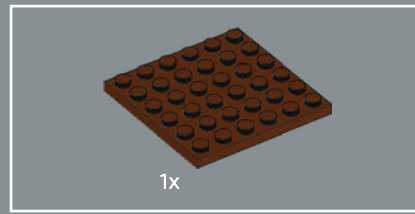
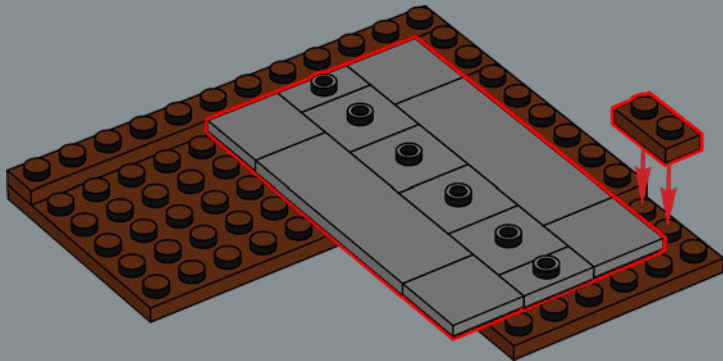

5

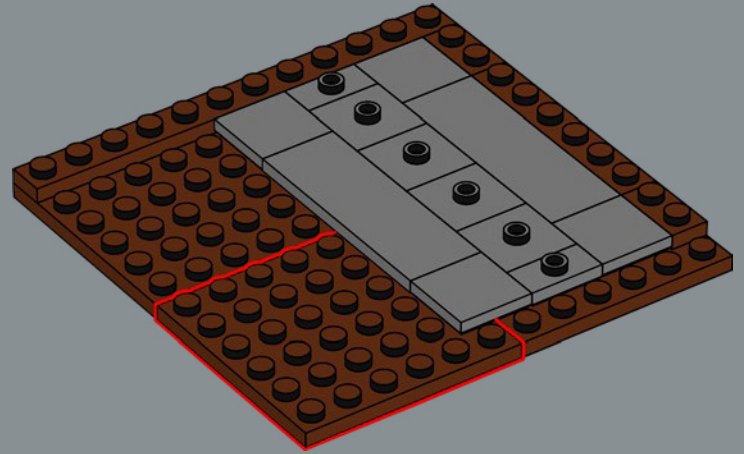

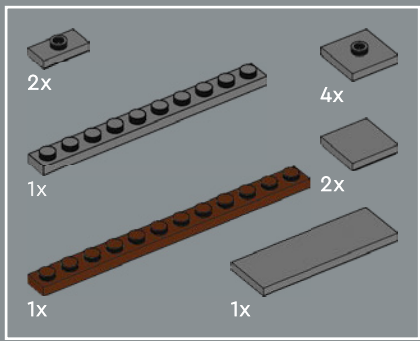

6

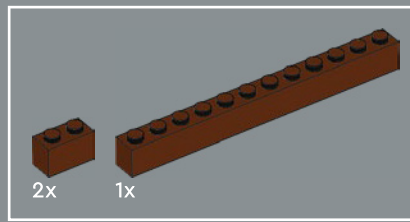
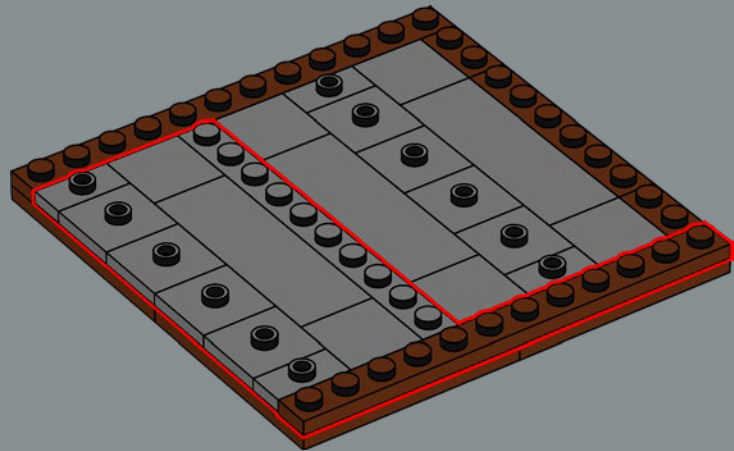

7

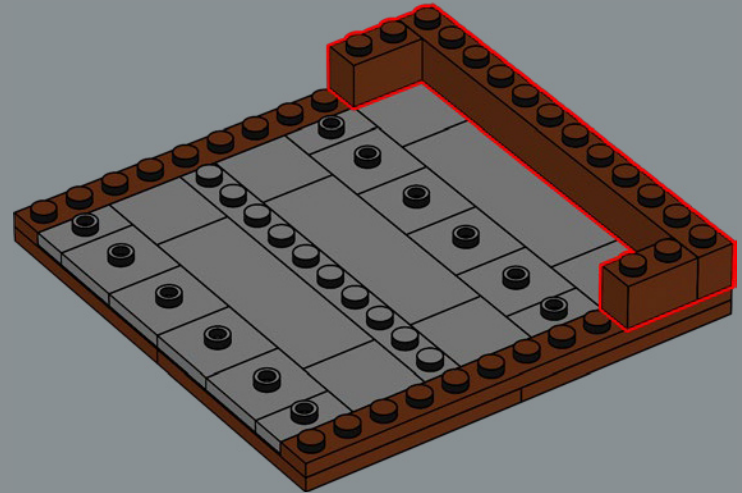

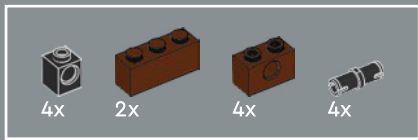

8

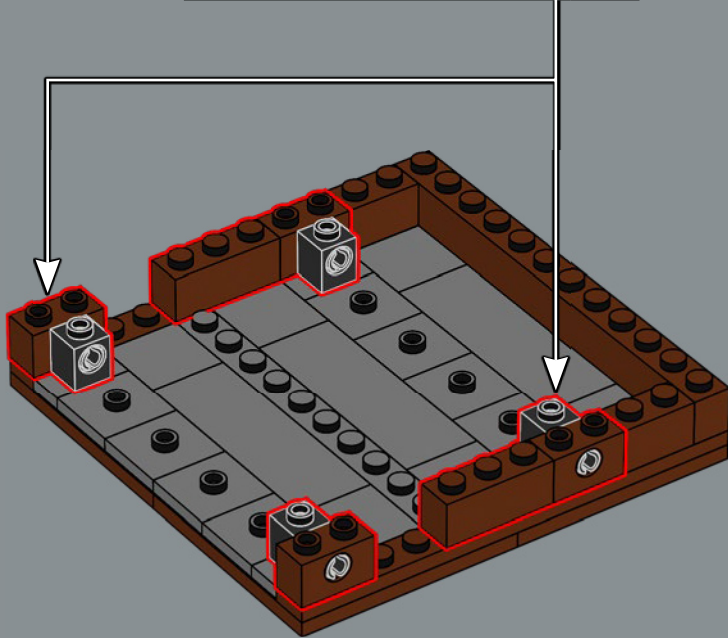
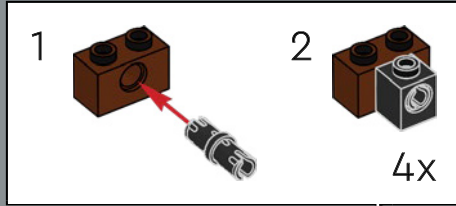

9

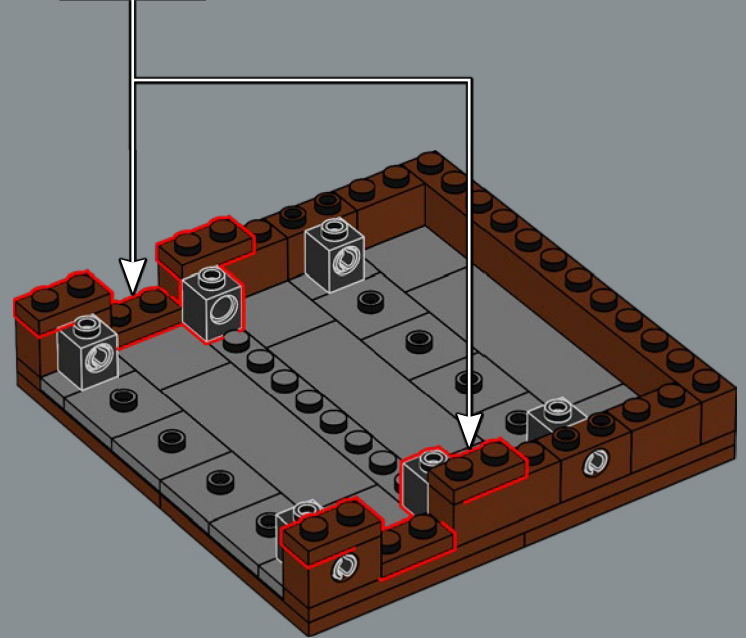
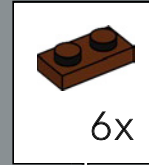

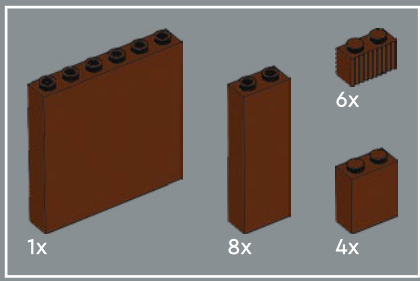

10

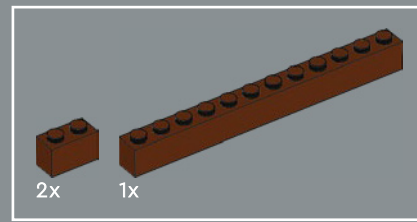
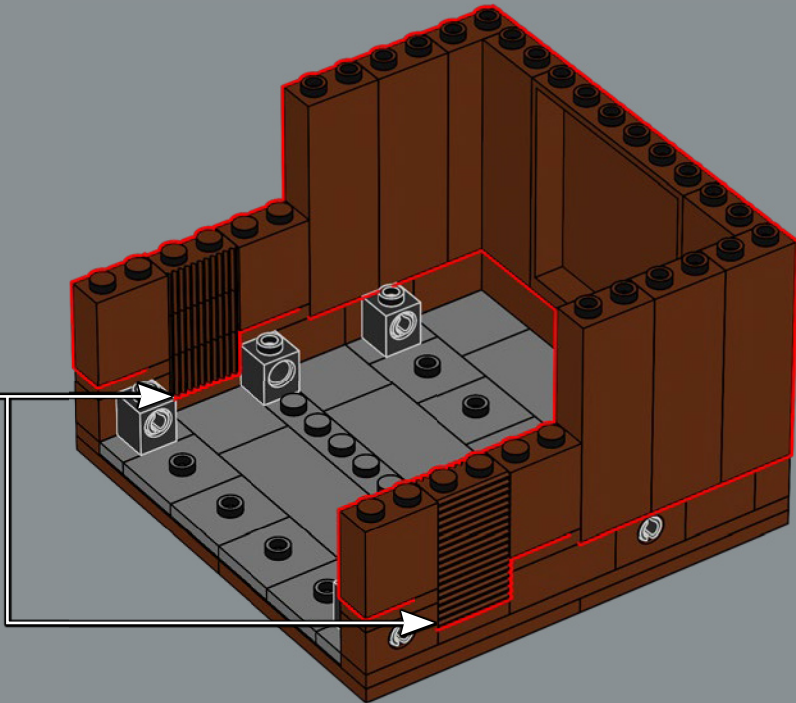
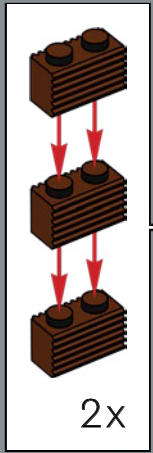

11

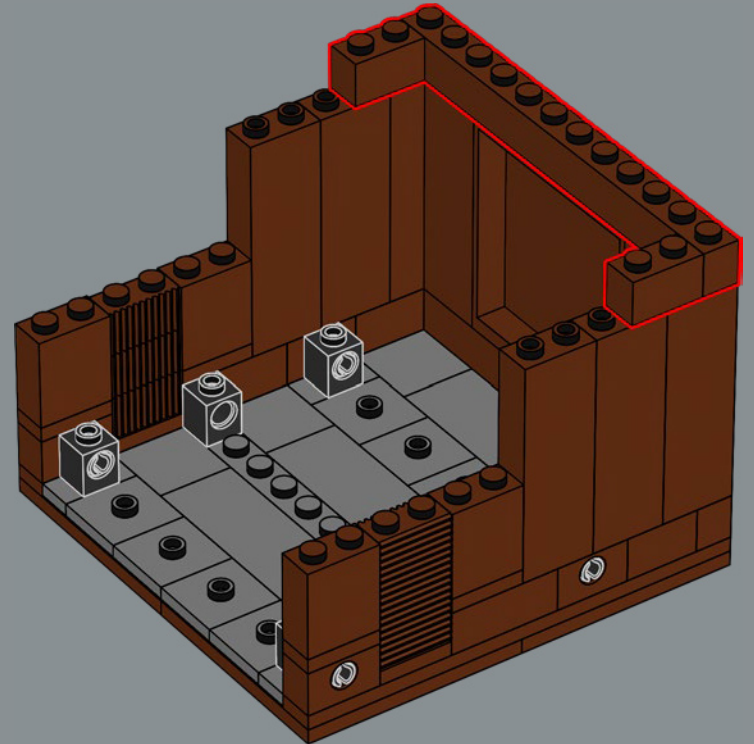

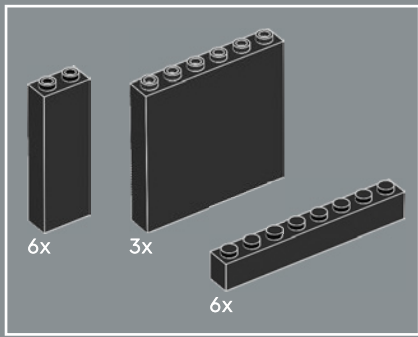

12

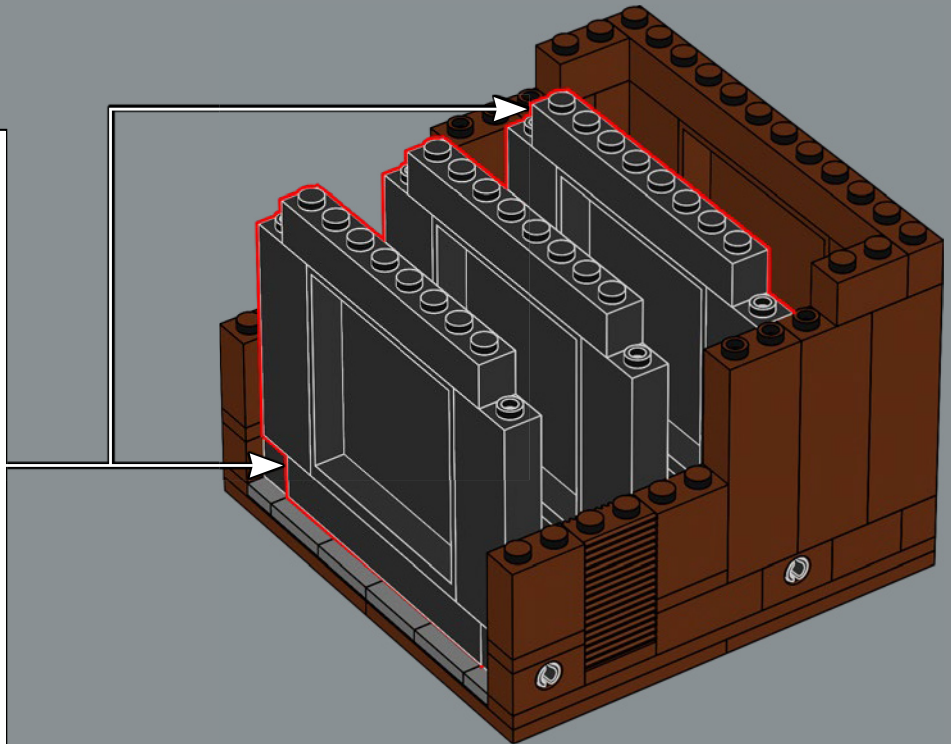
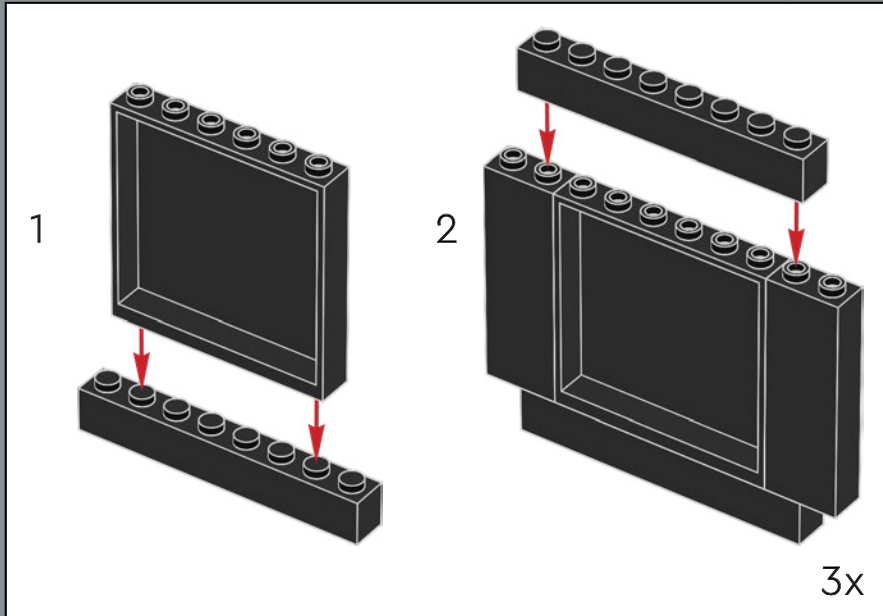

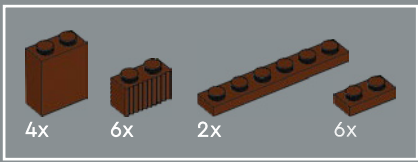

13

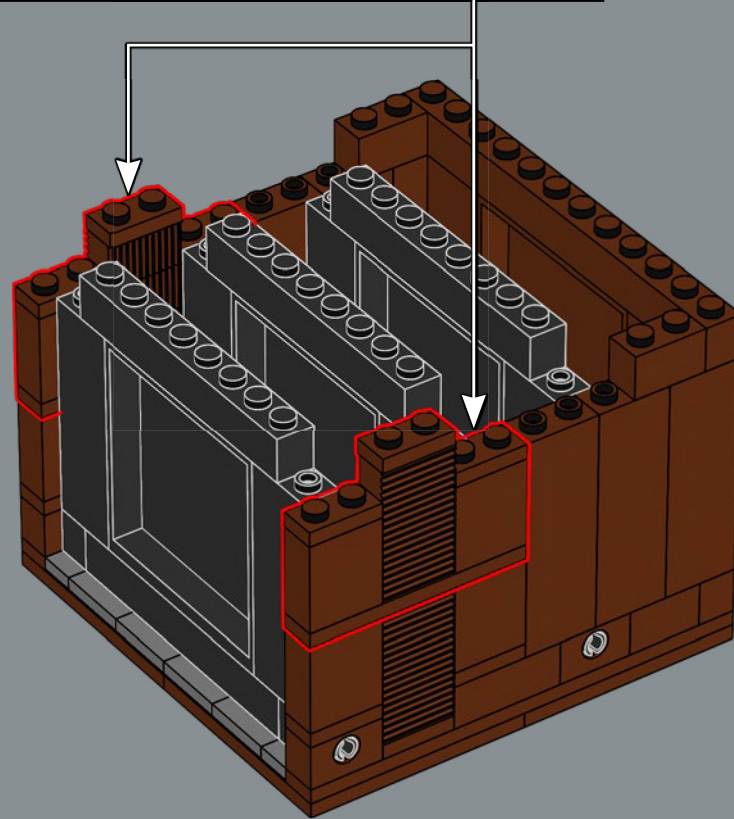
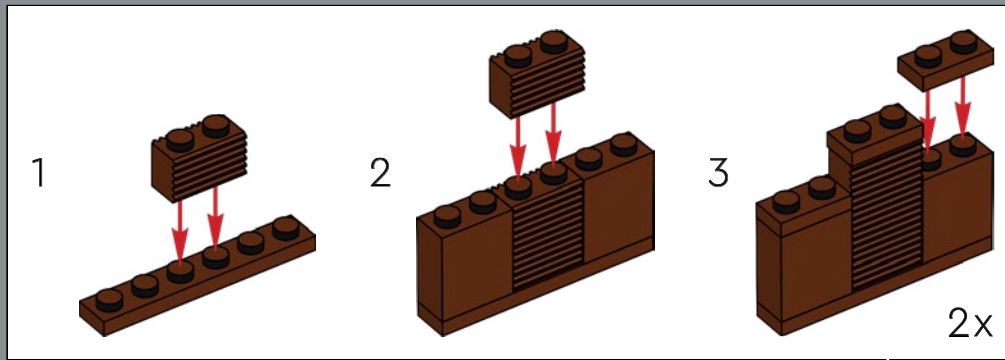

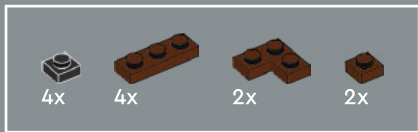

14

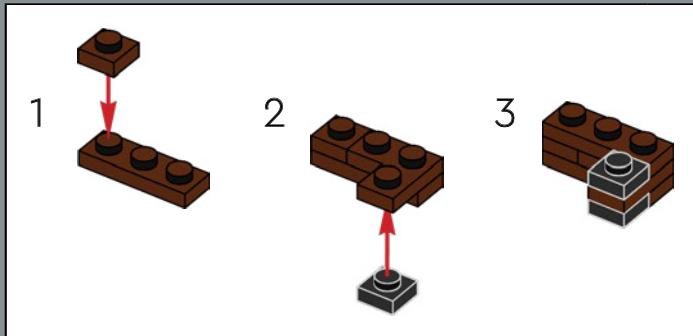
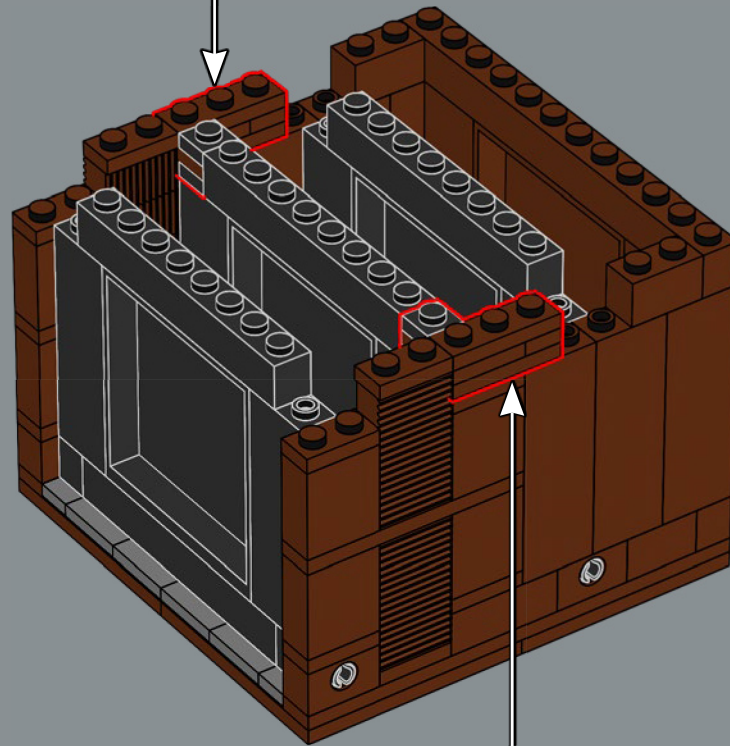
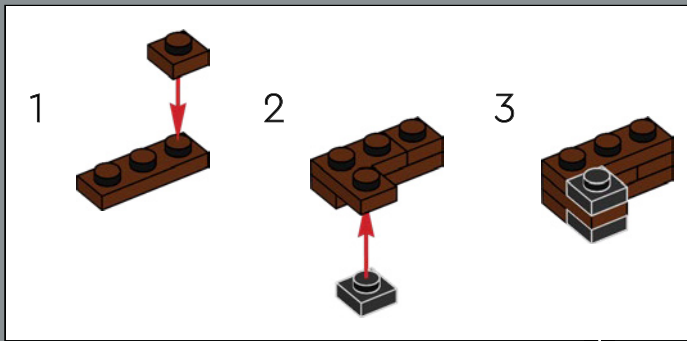

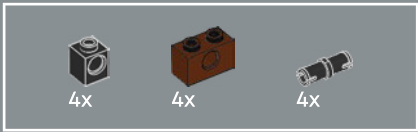

15

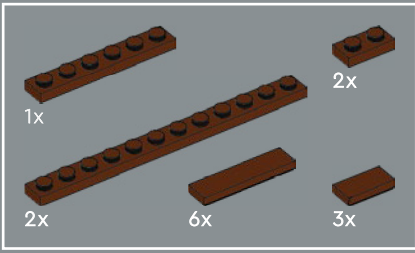
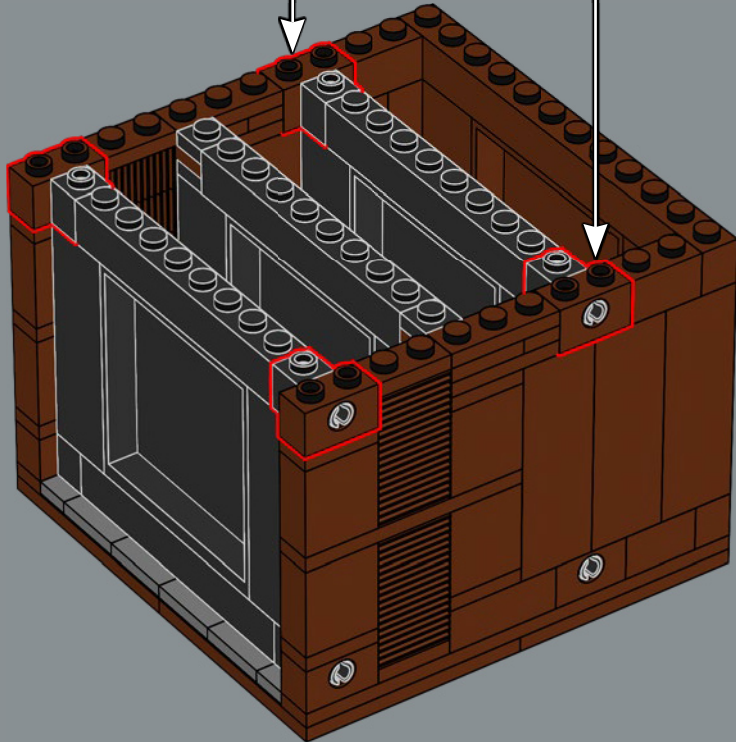
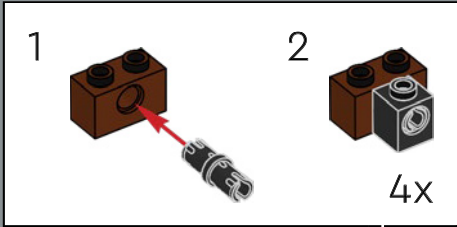

16

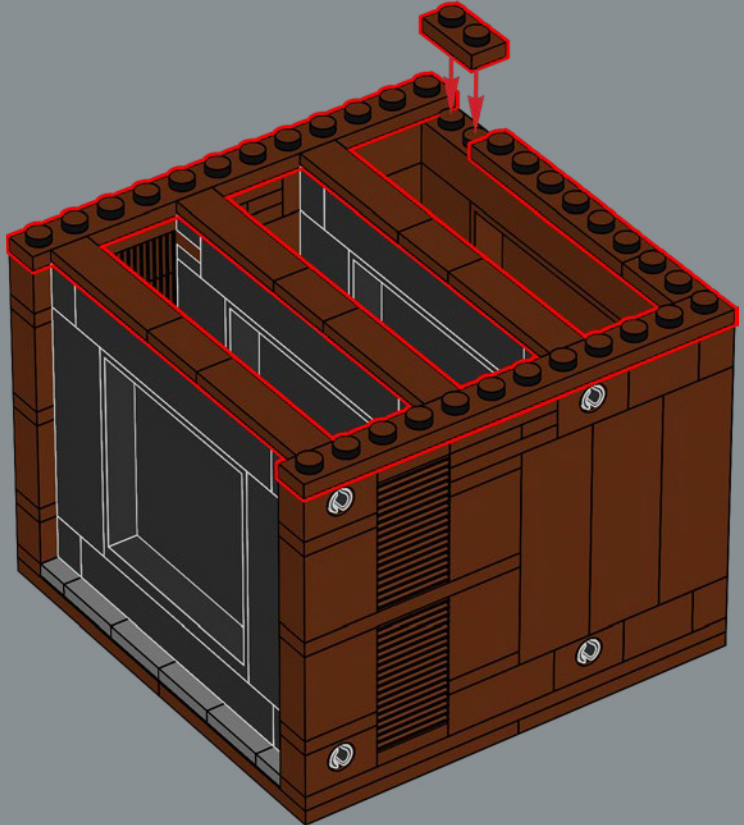

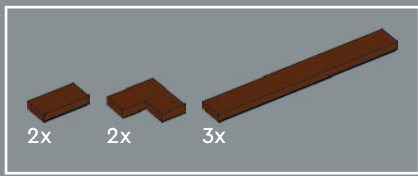

17

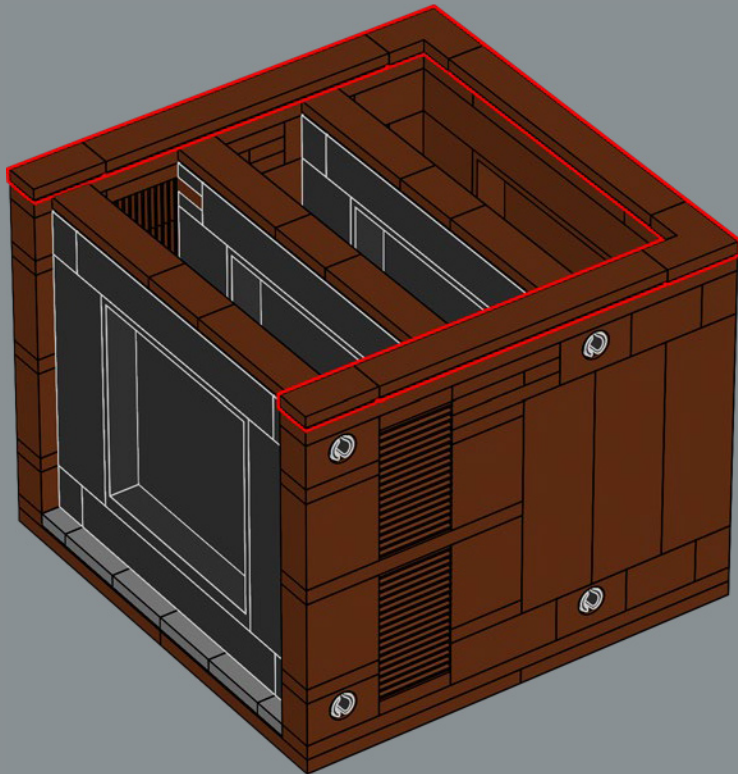

18



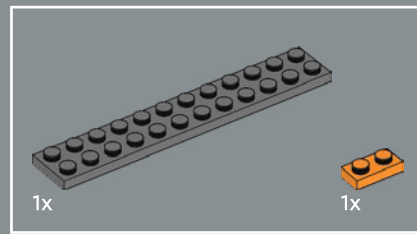
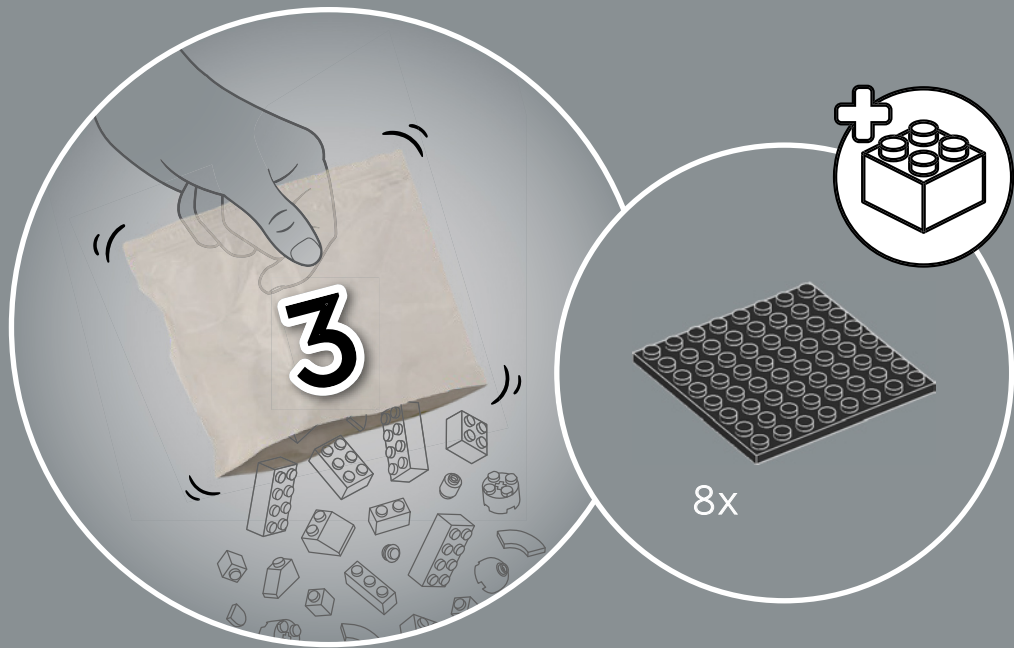

1

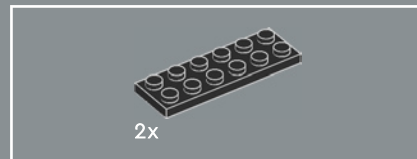
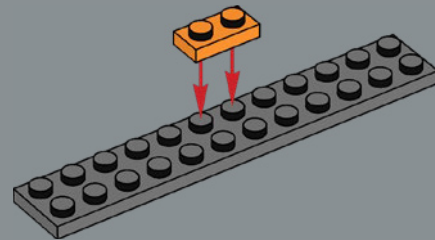

2

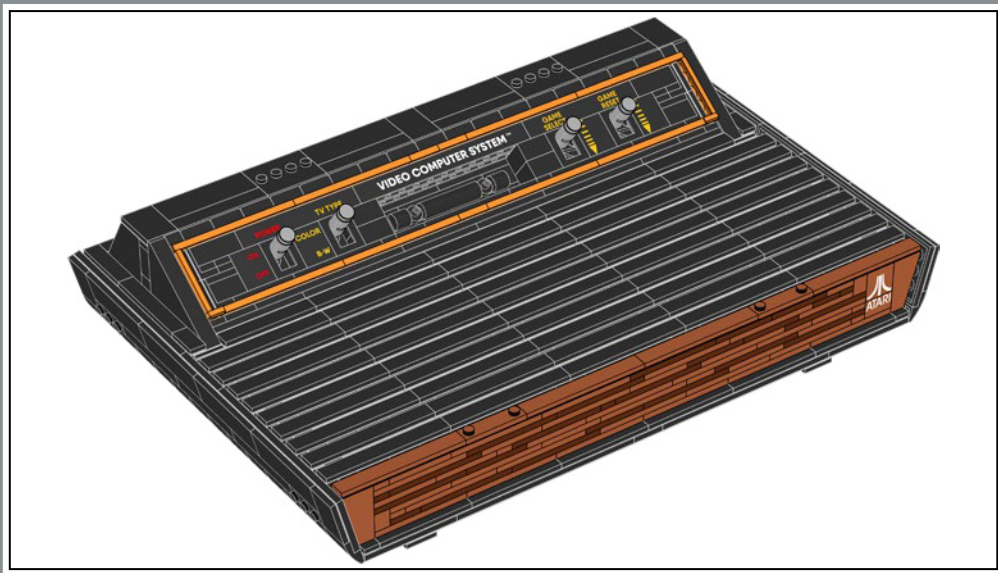
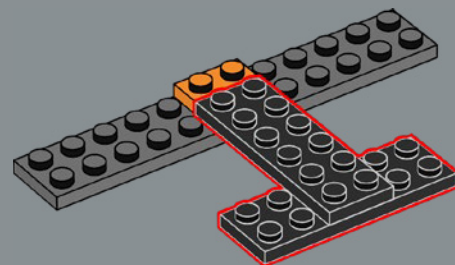

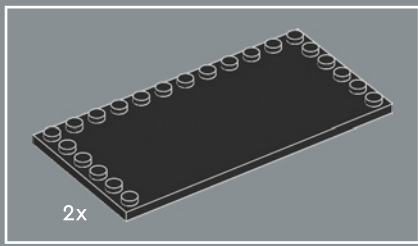

3

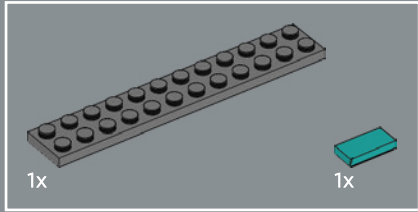
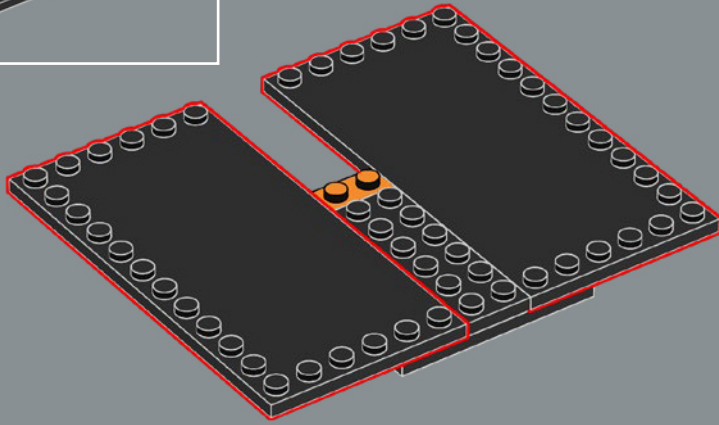

4

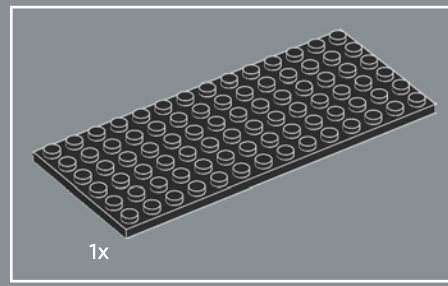
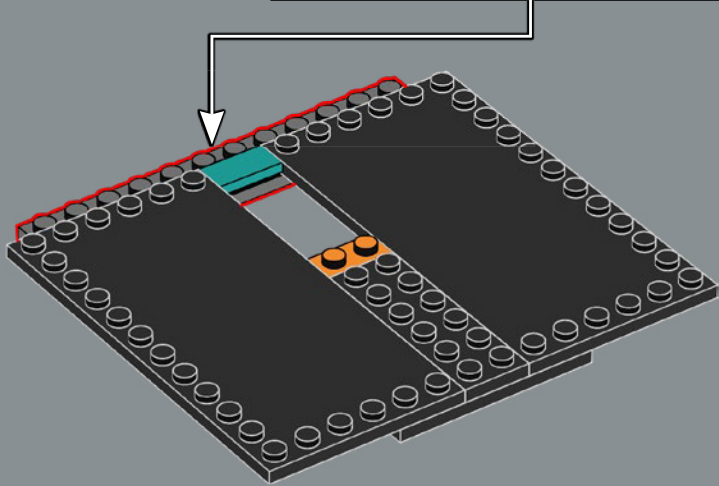
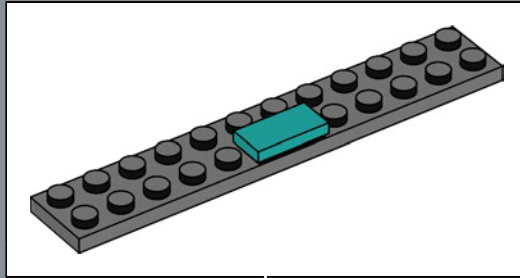

5

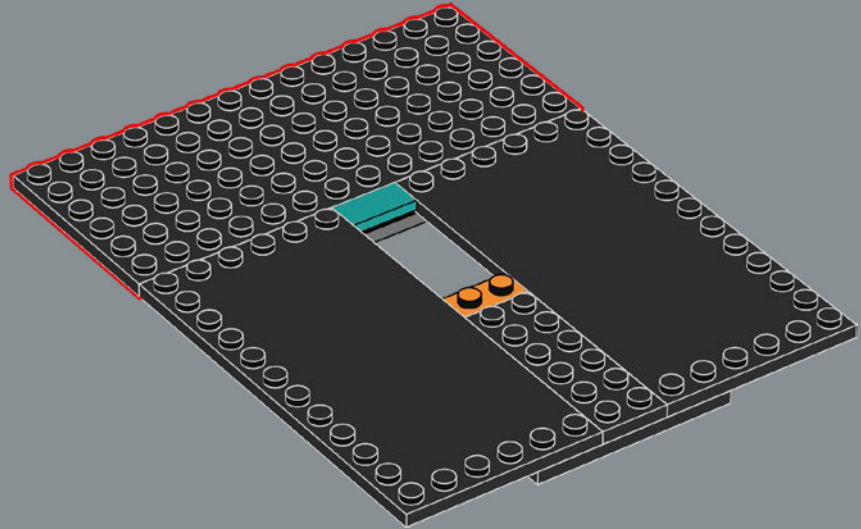

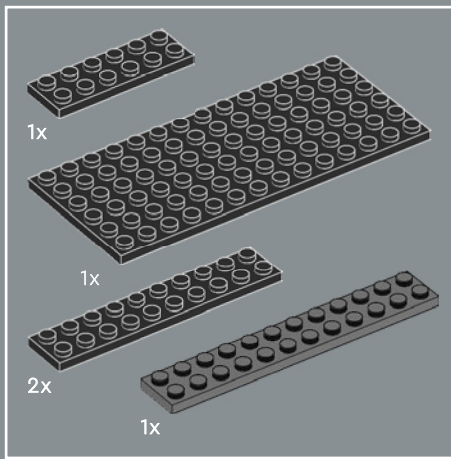

6

1

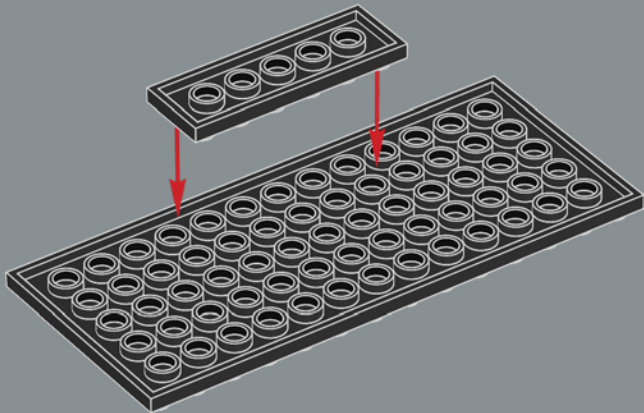

2

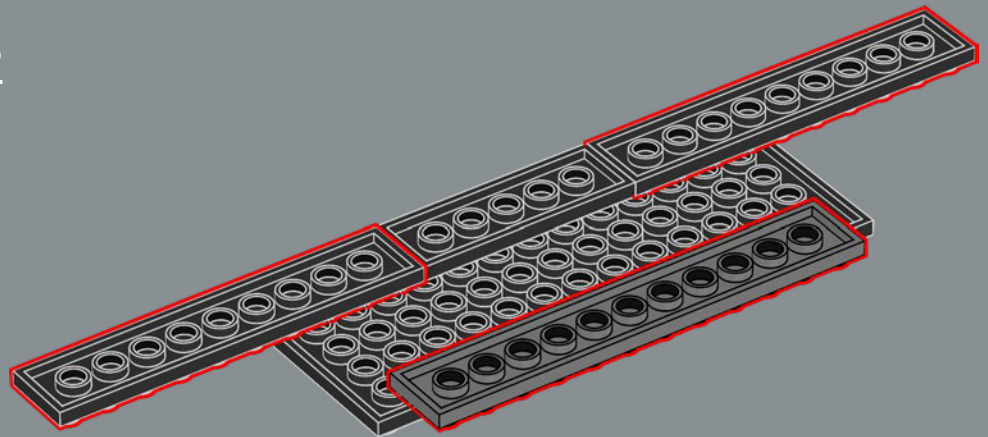

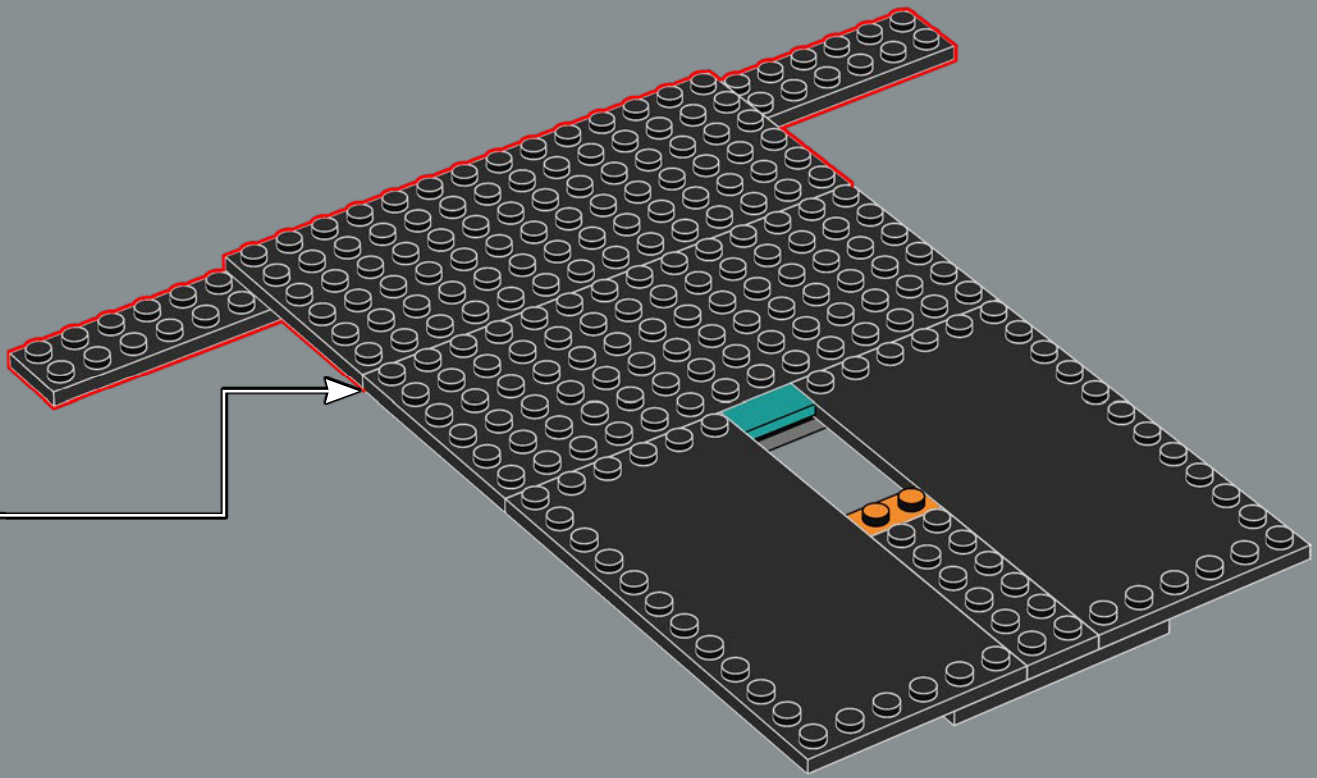

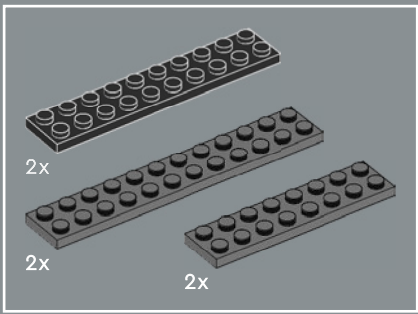

7

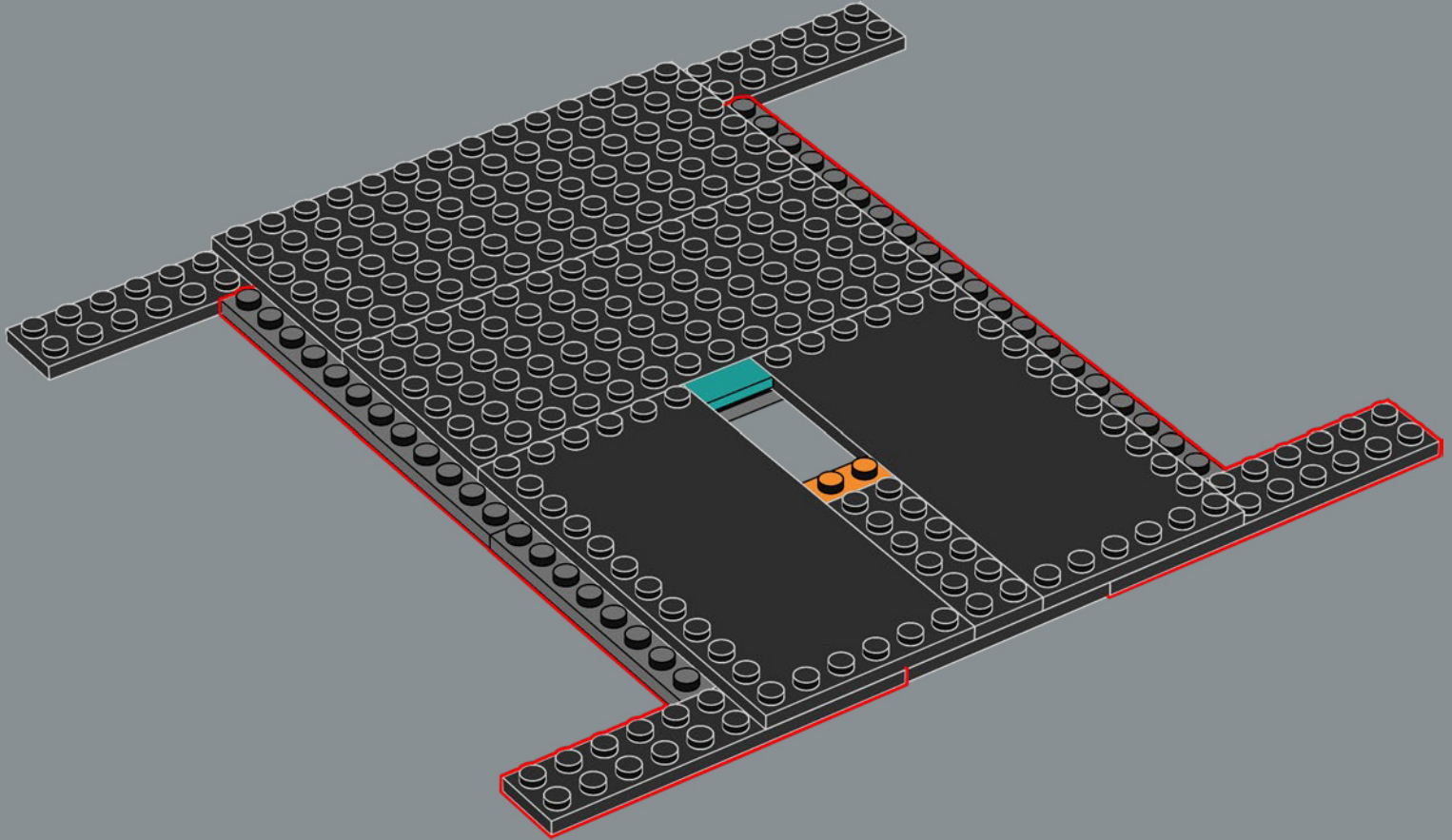

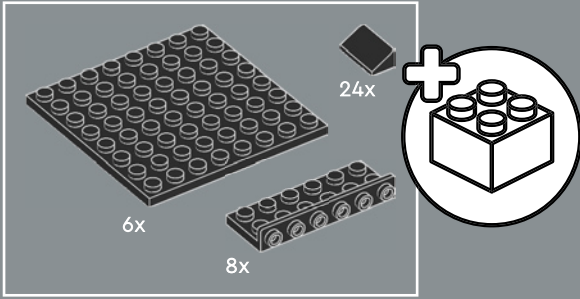
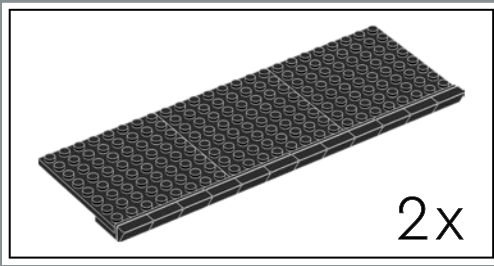

8

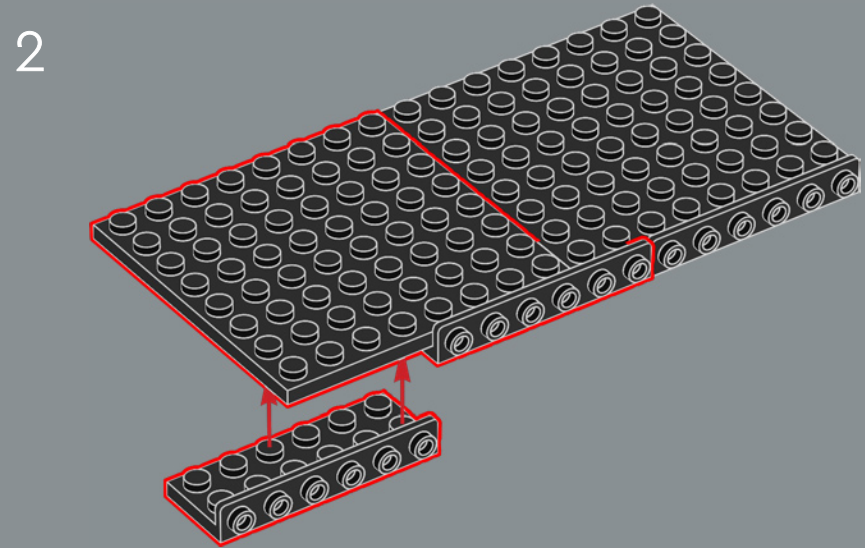
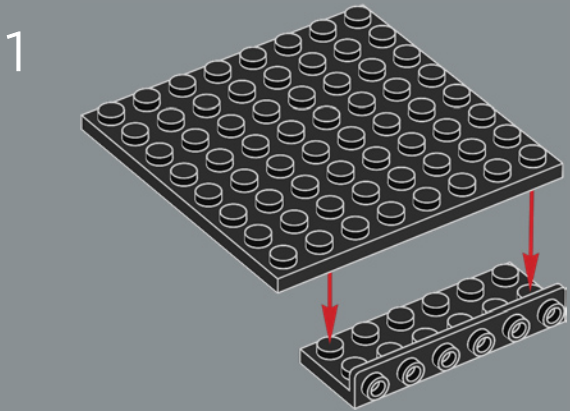

3

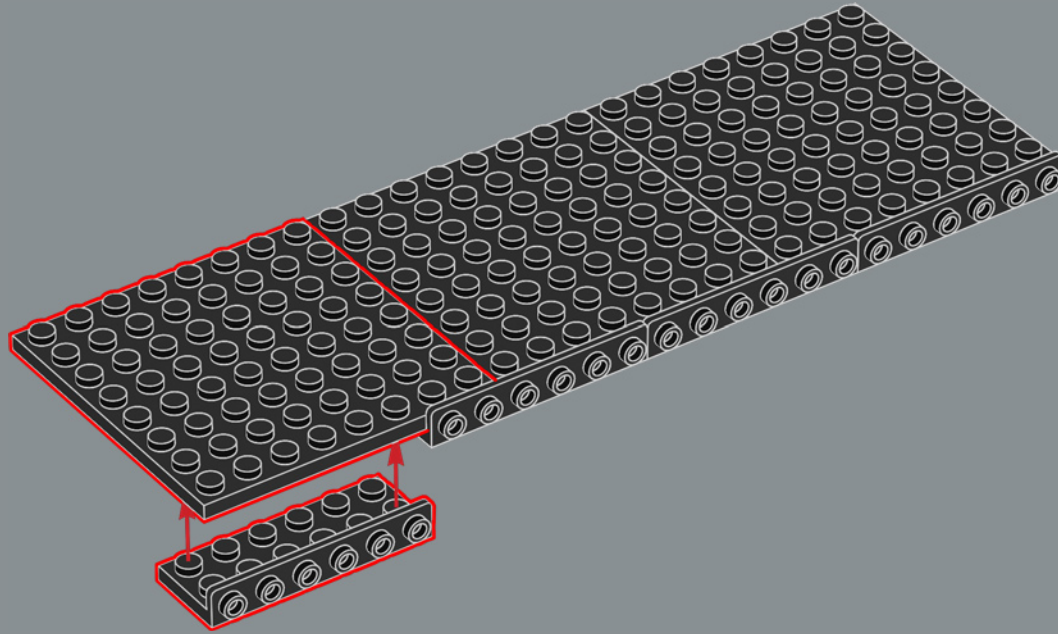

4

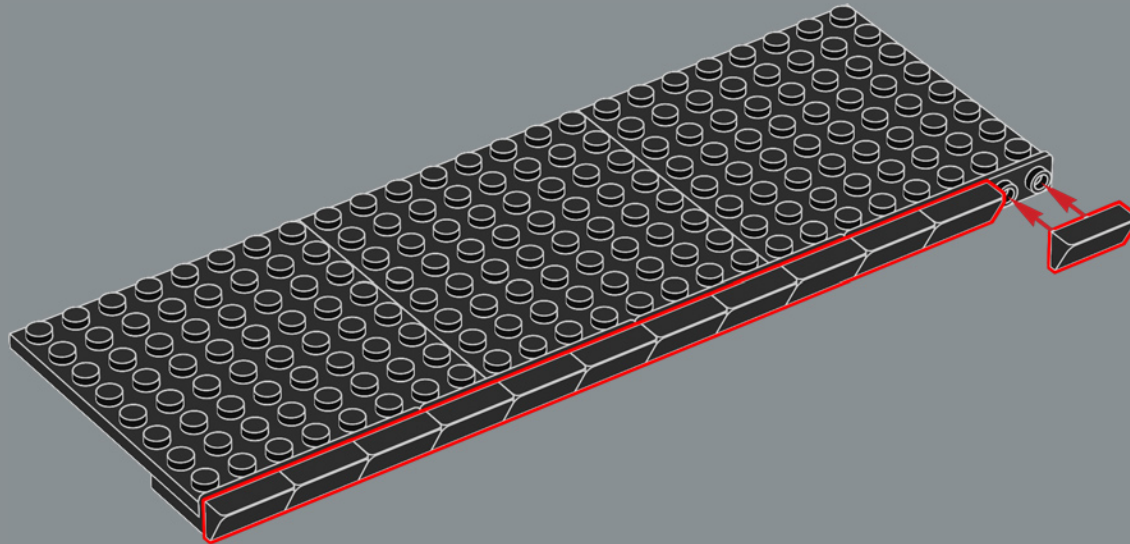

2x

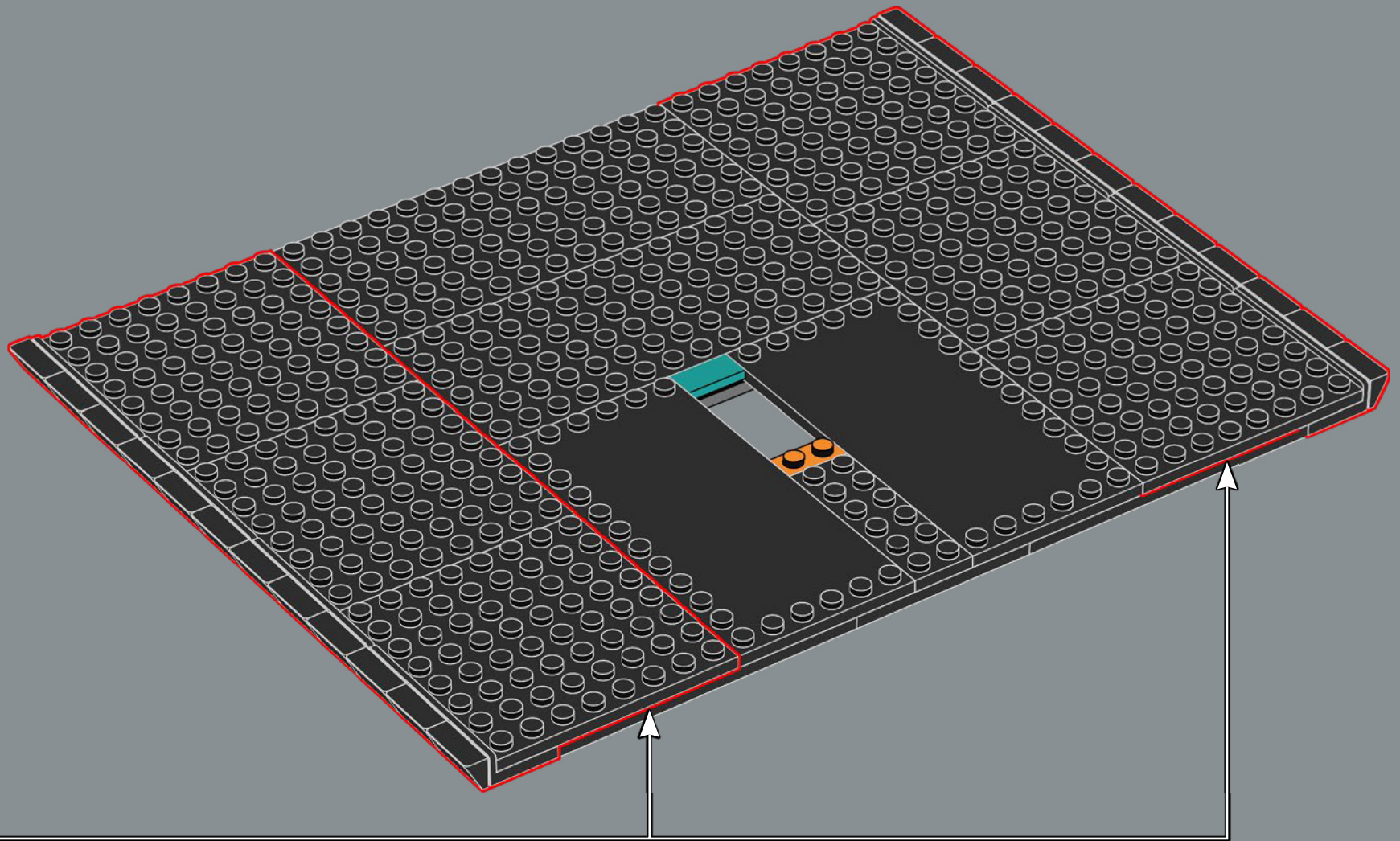

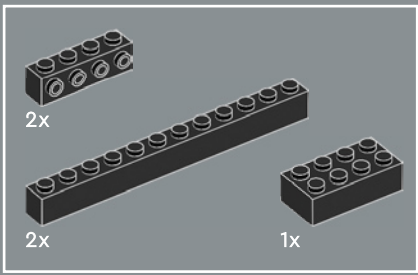

9

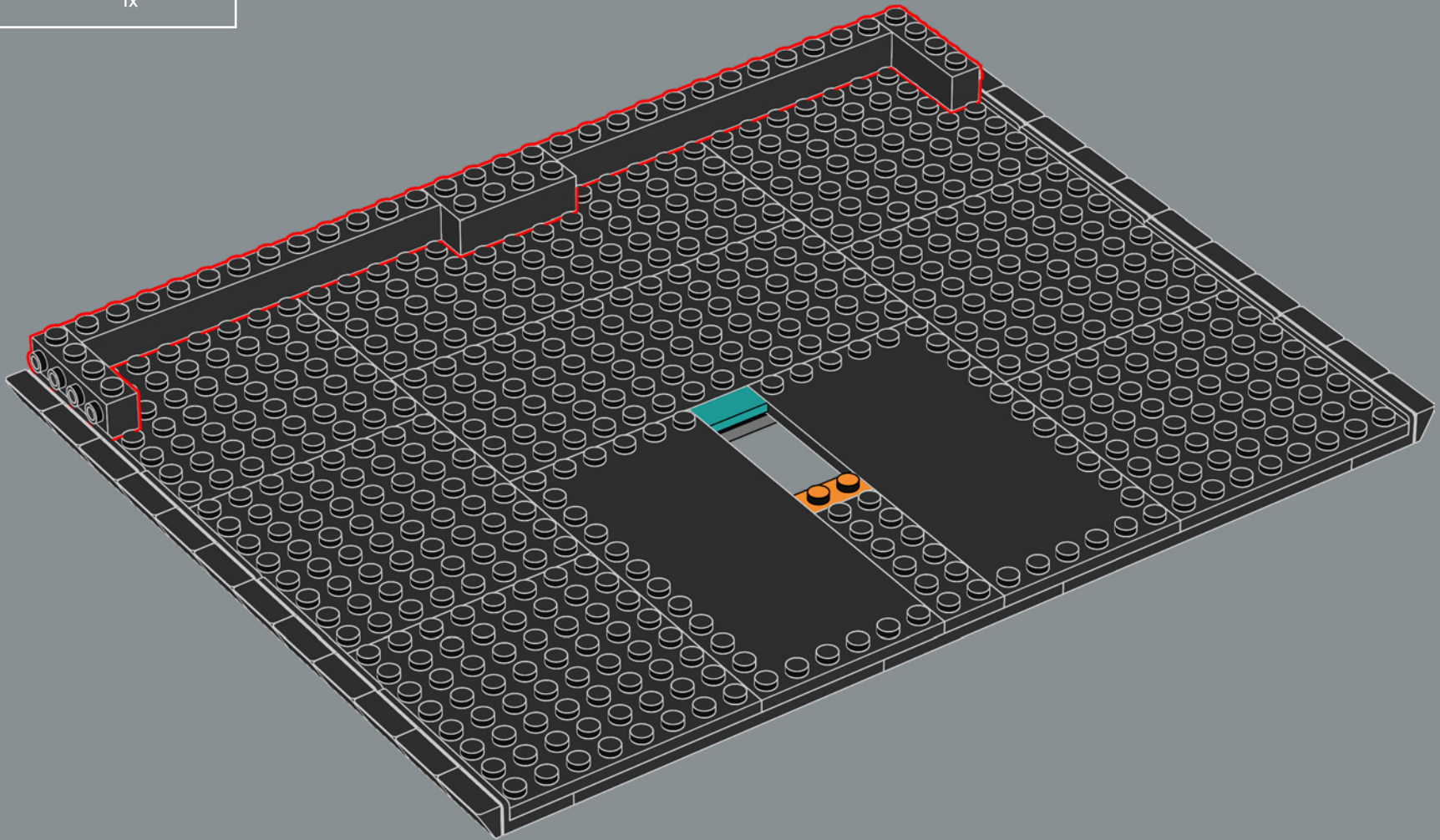

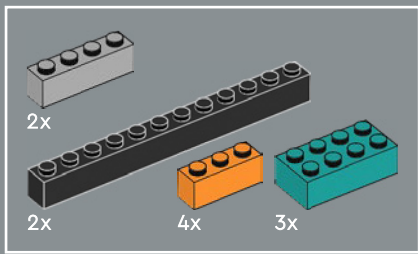

10

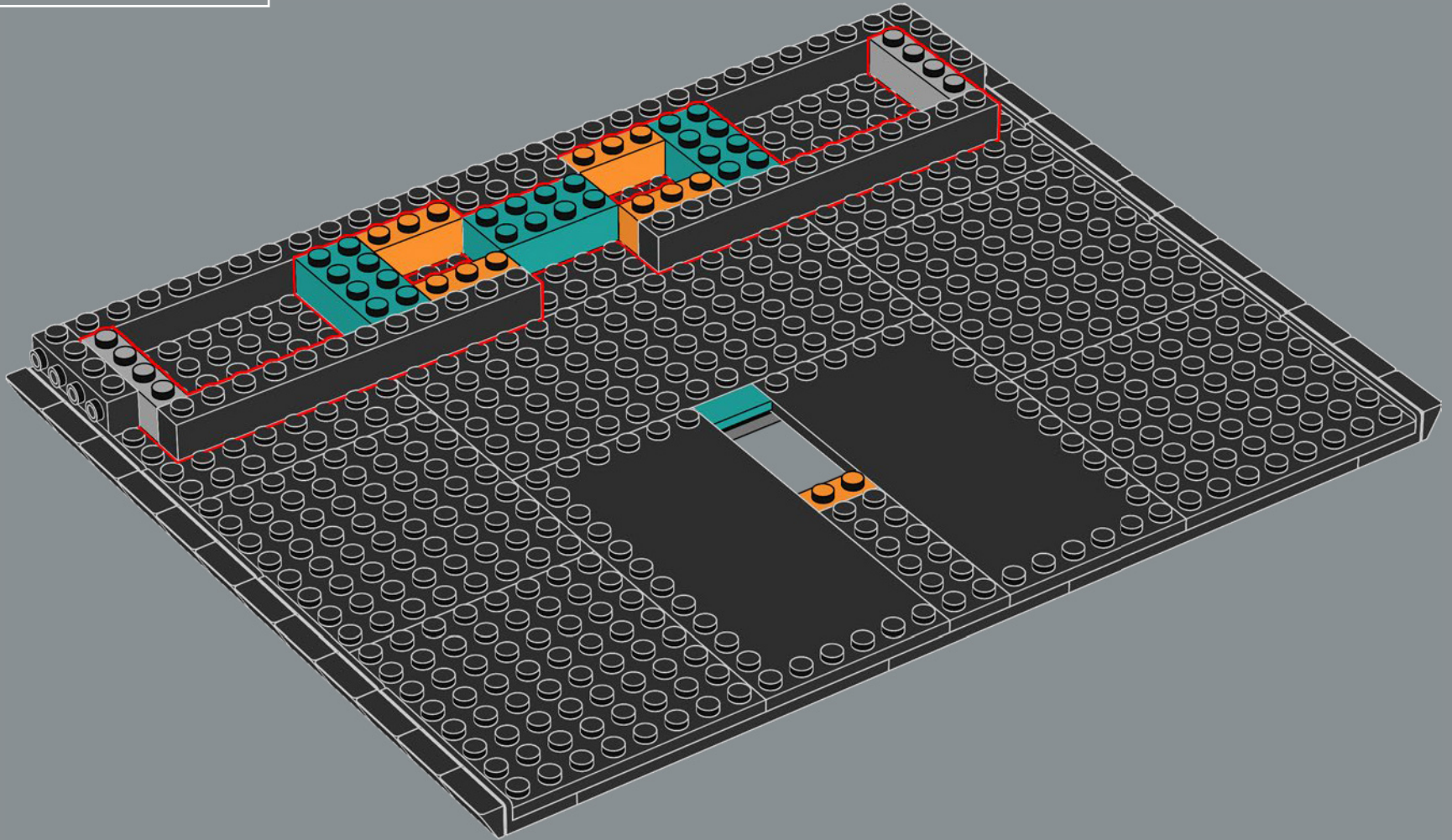

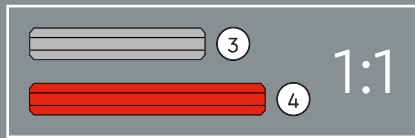
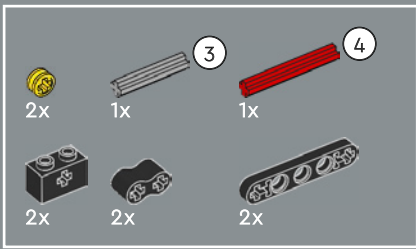

11

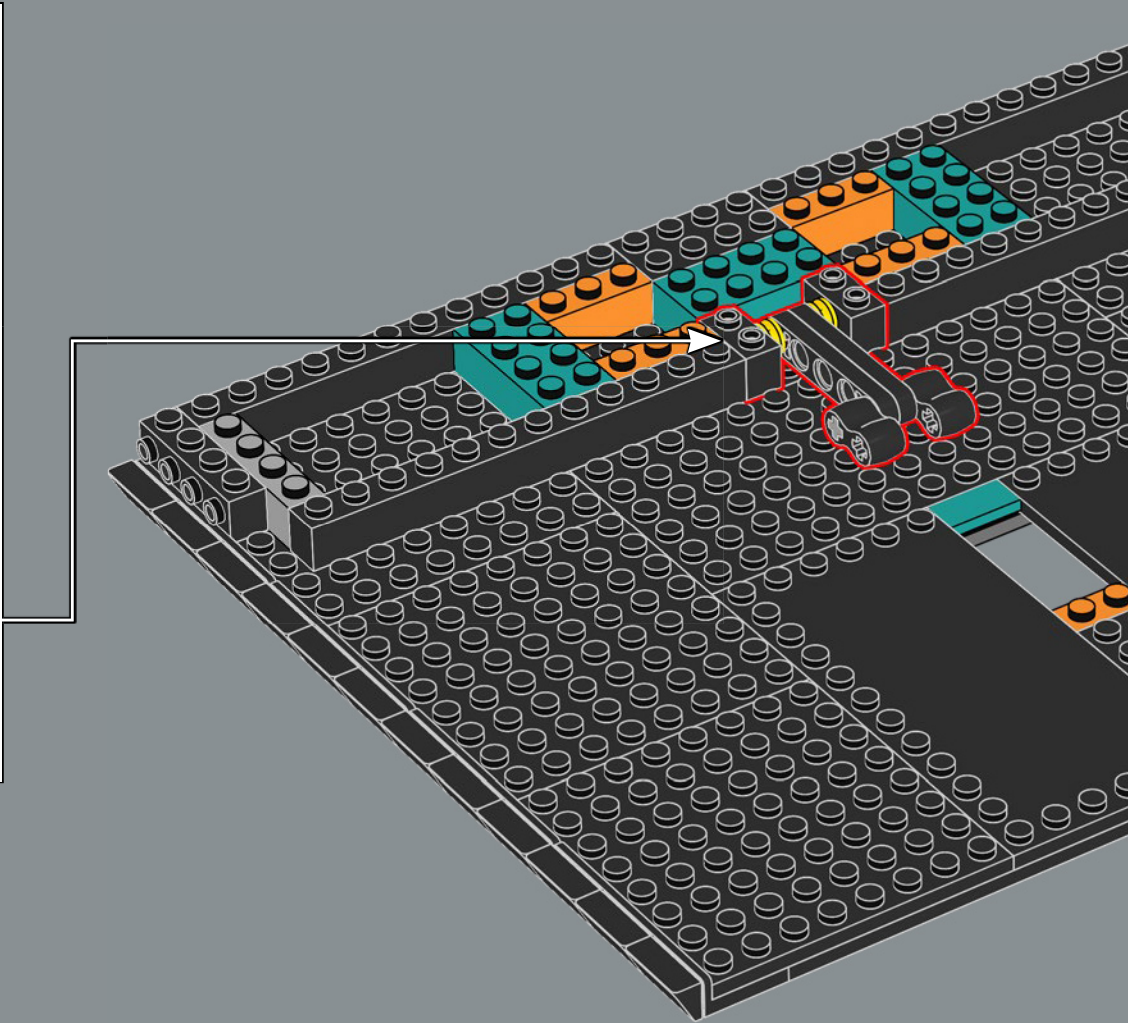
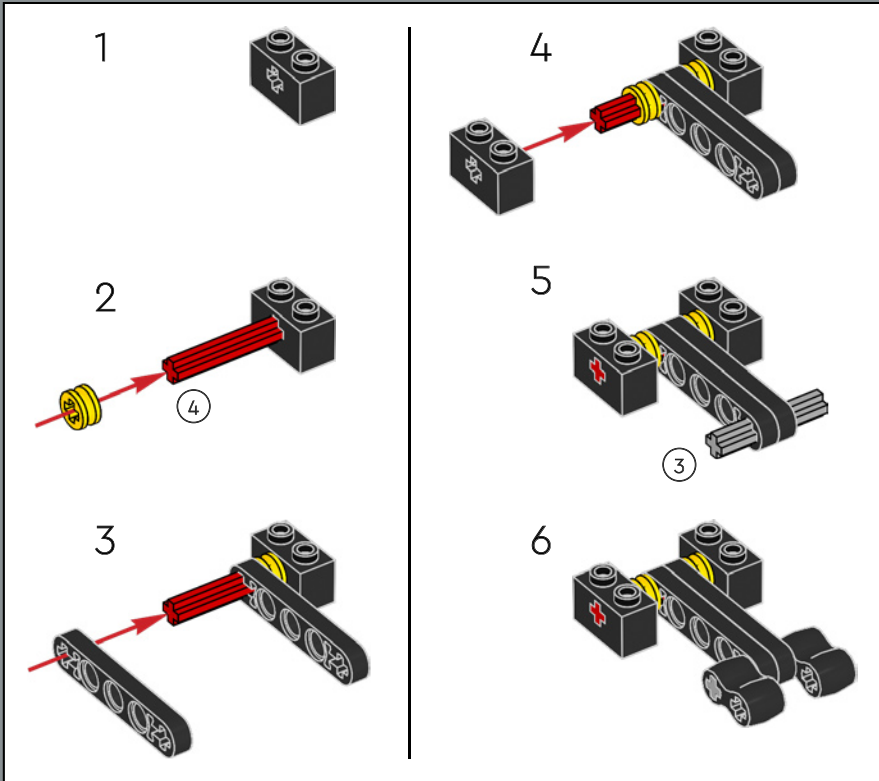

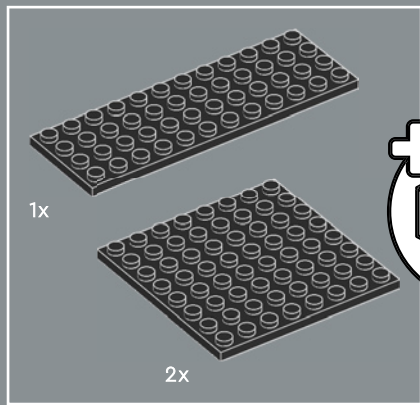

12

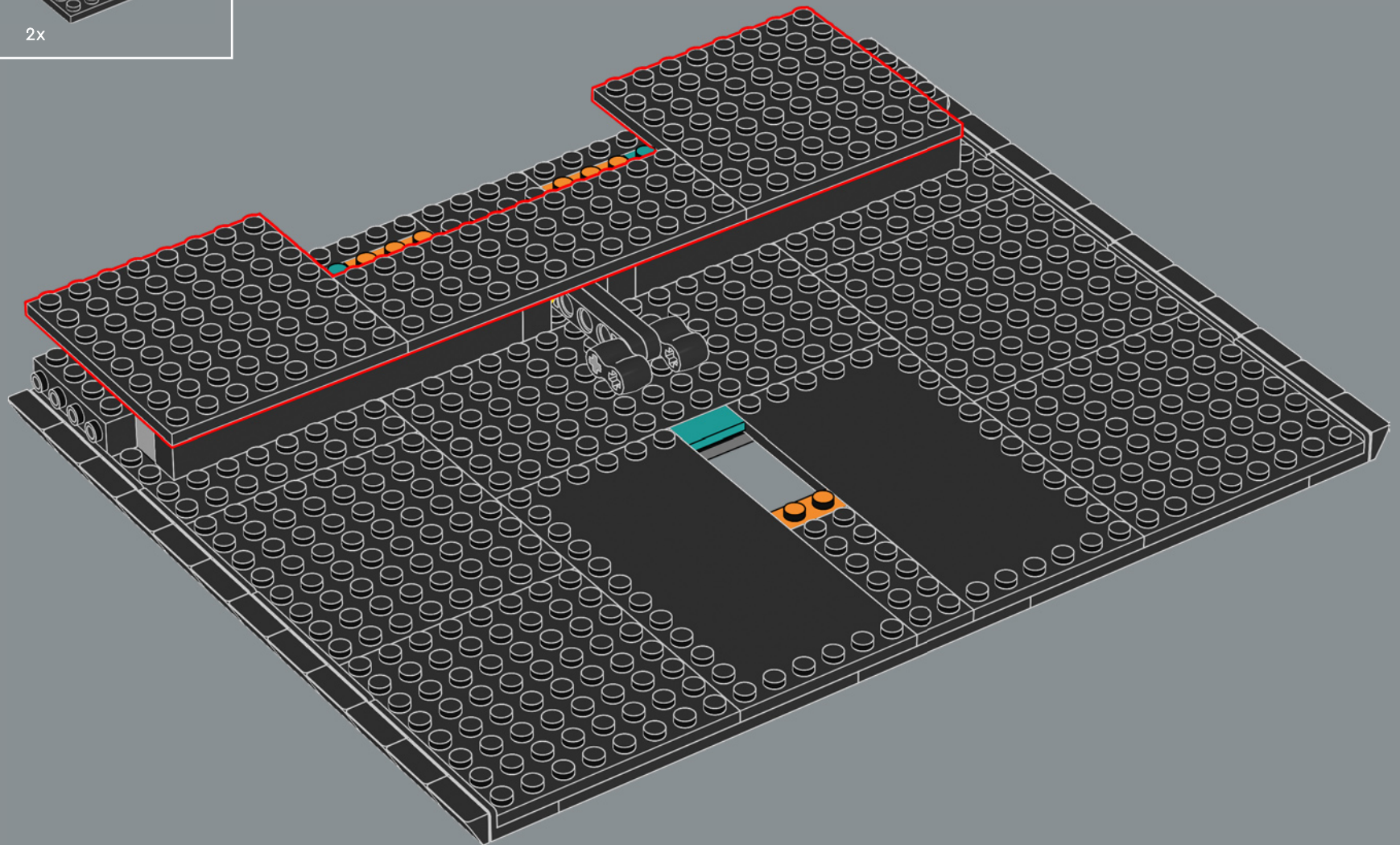

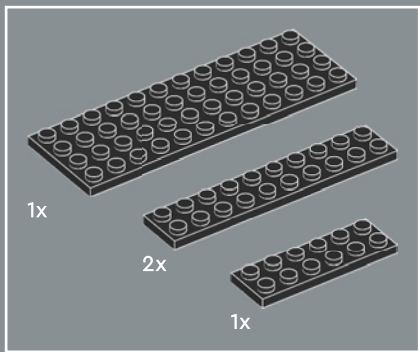

13

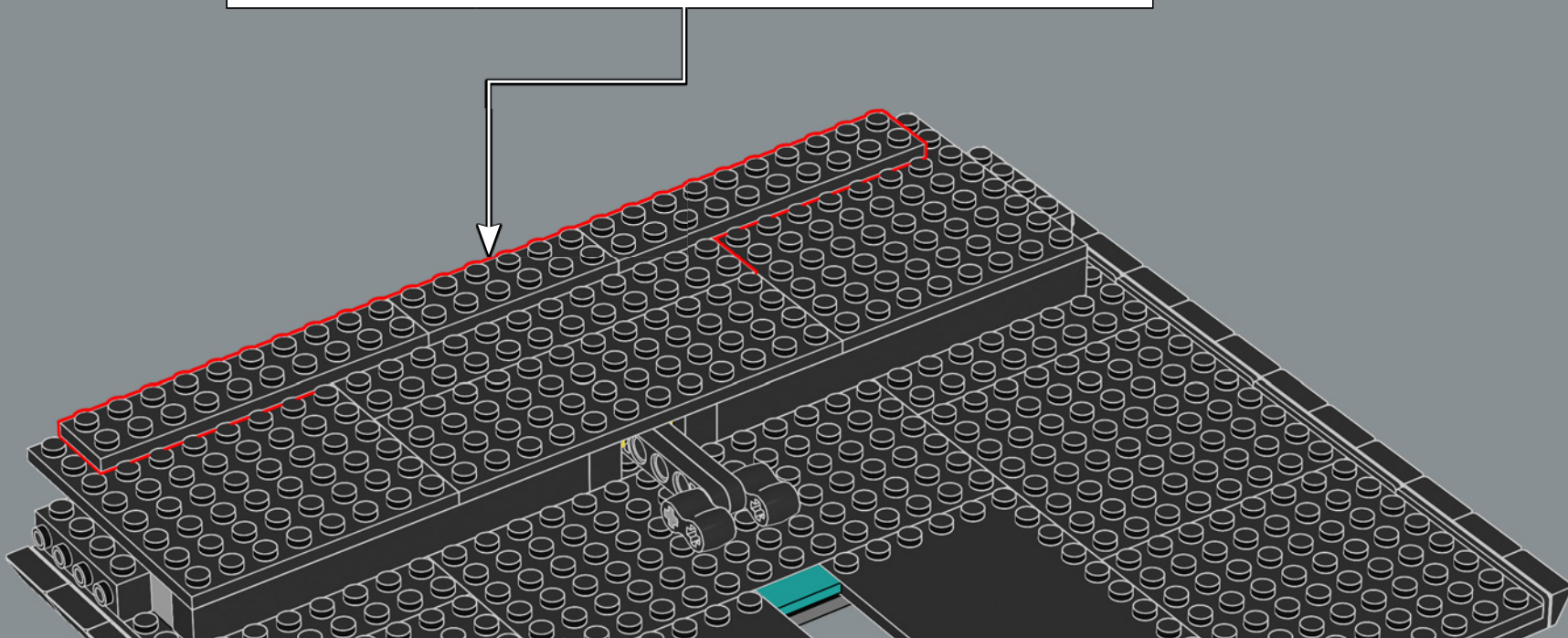
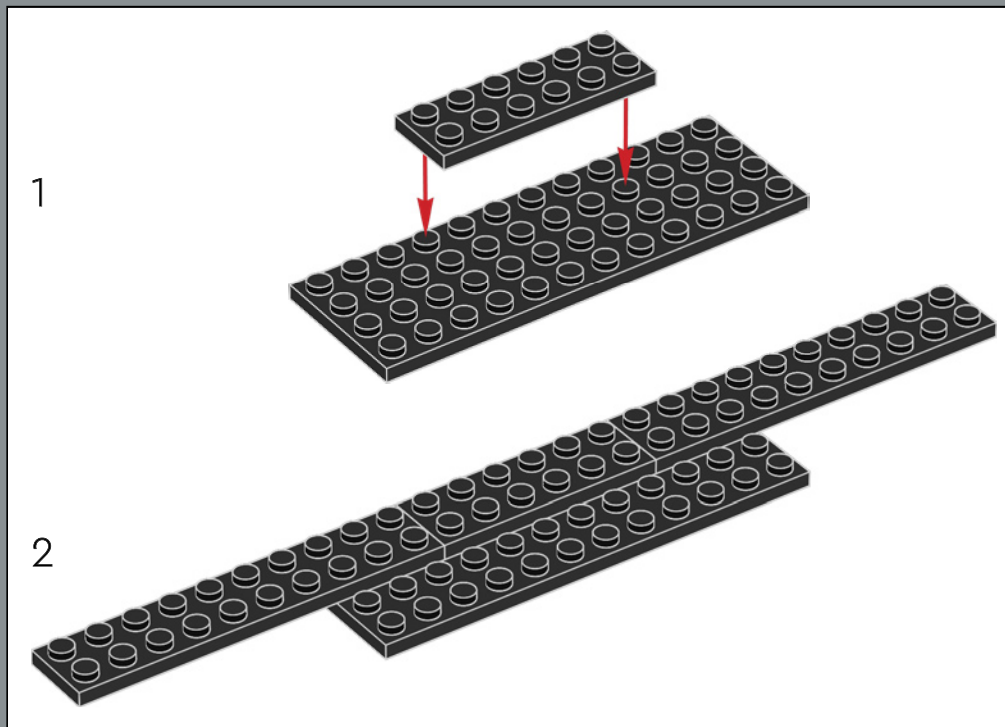

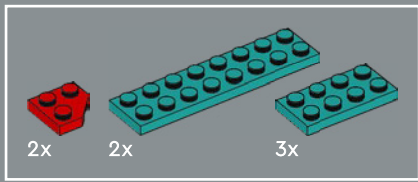

14

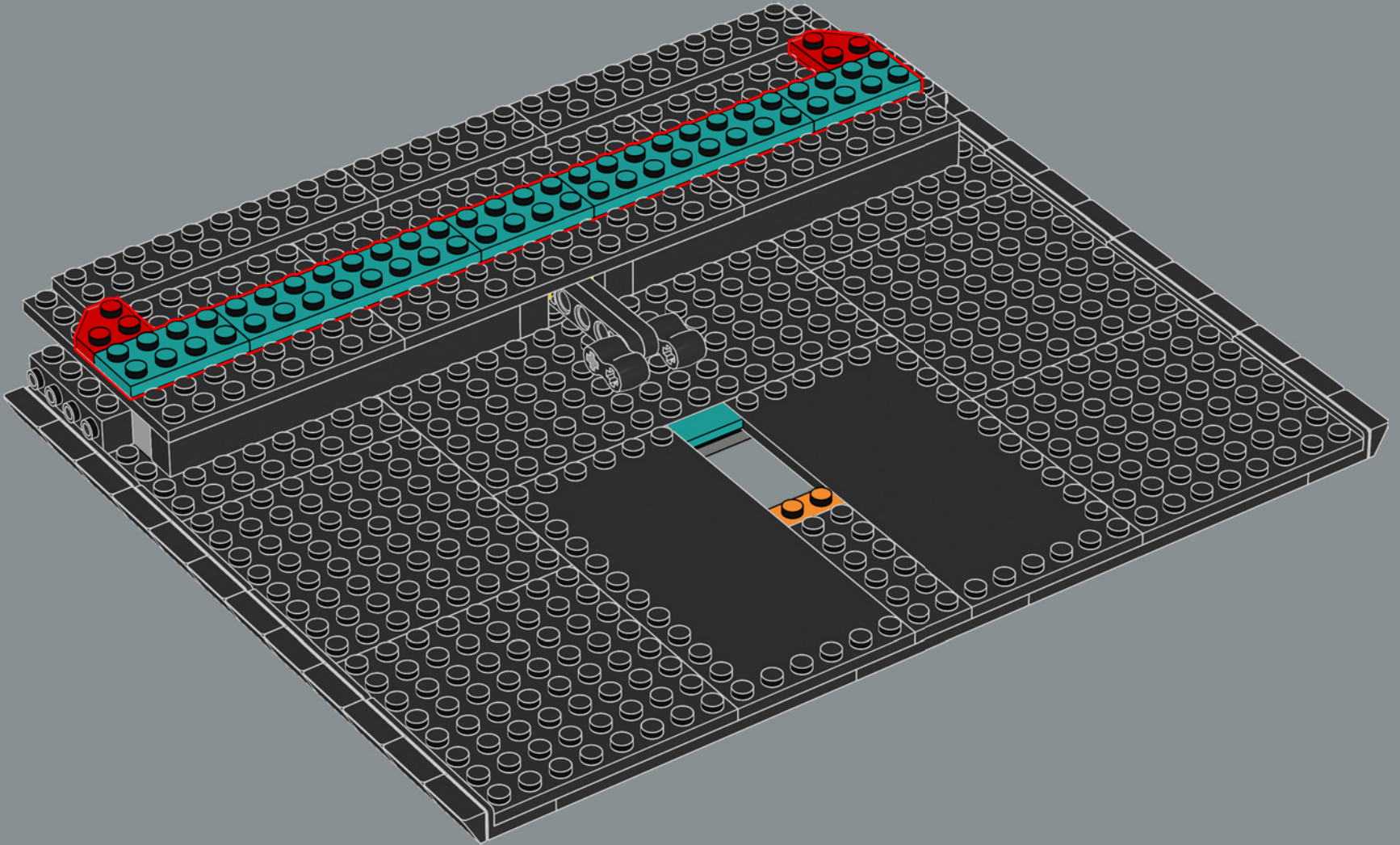

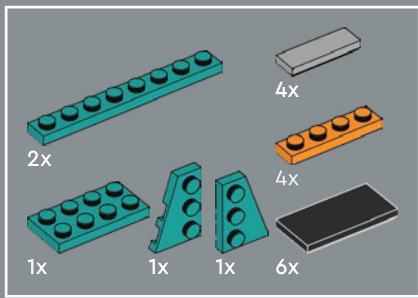

15

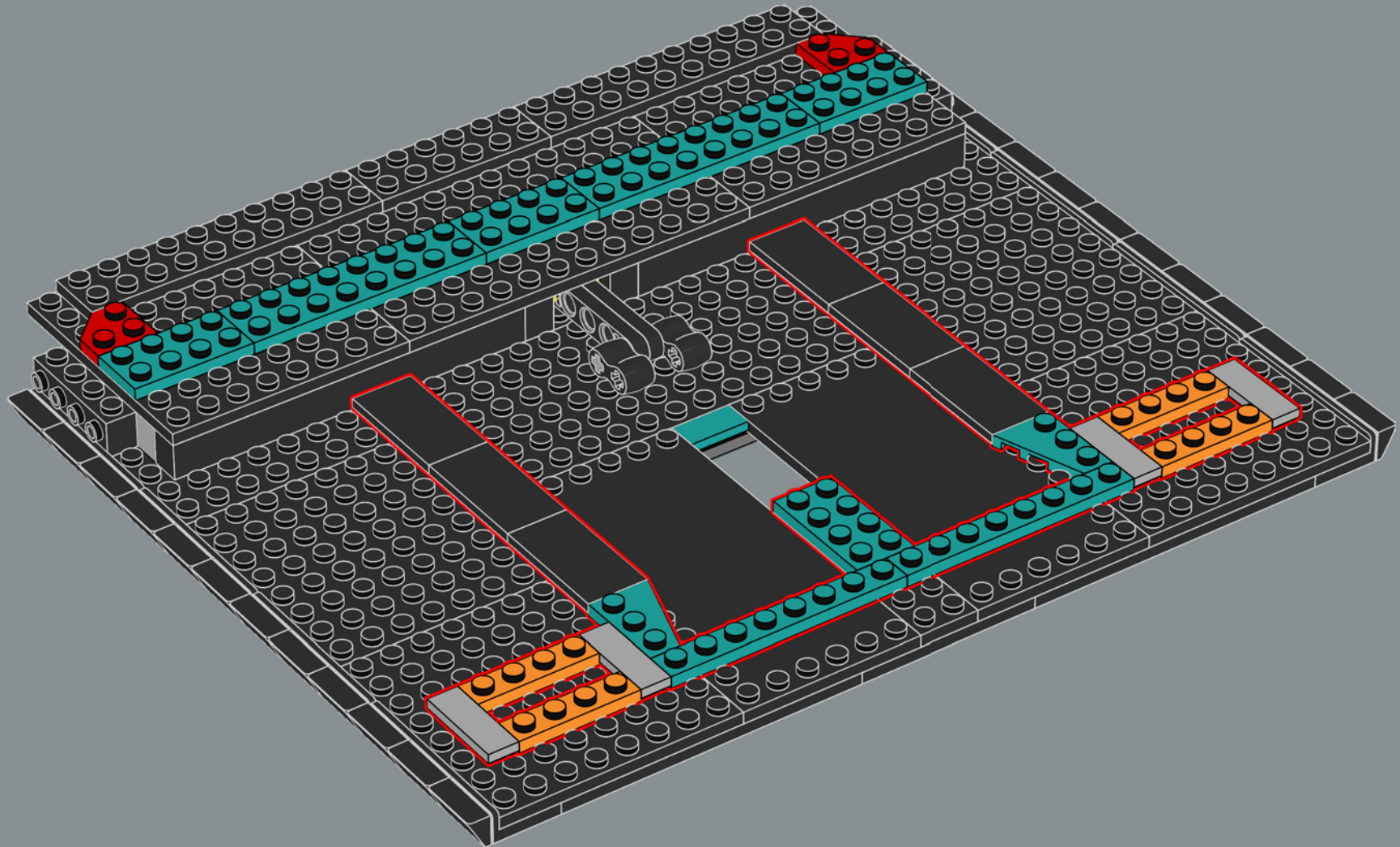

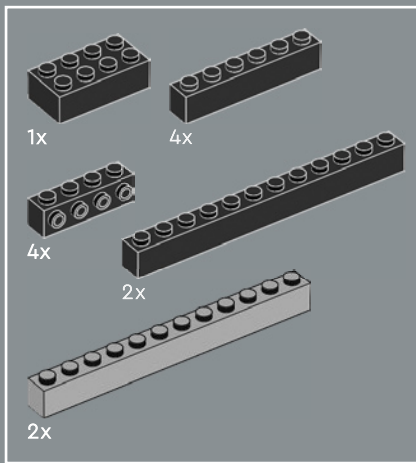

16

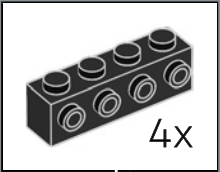
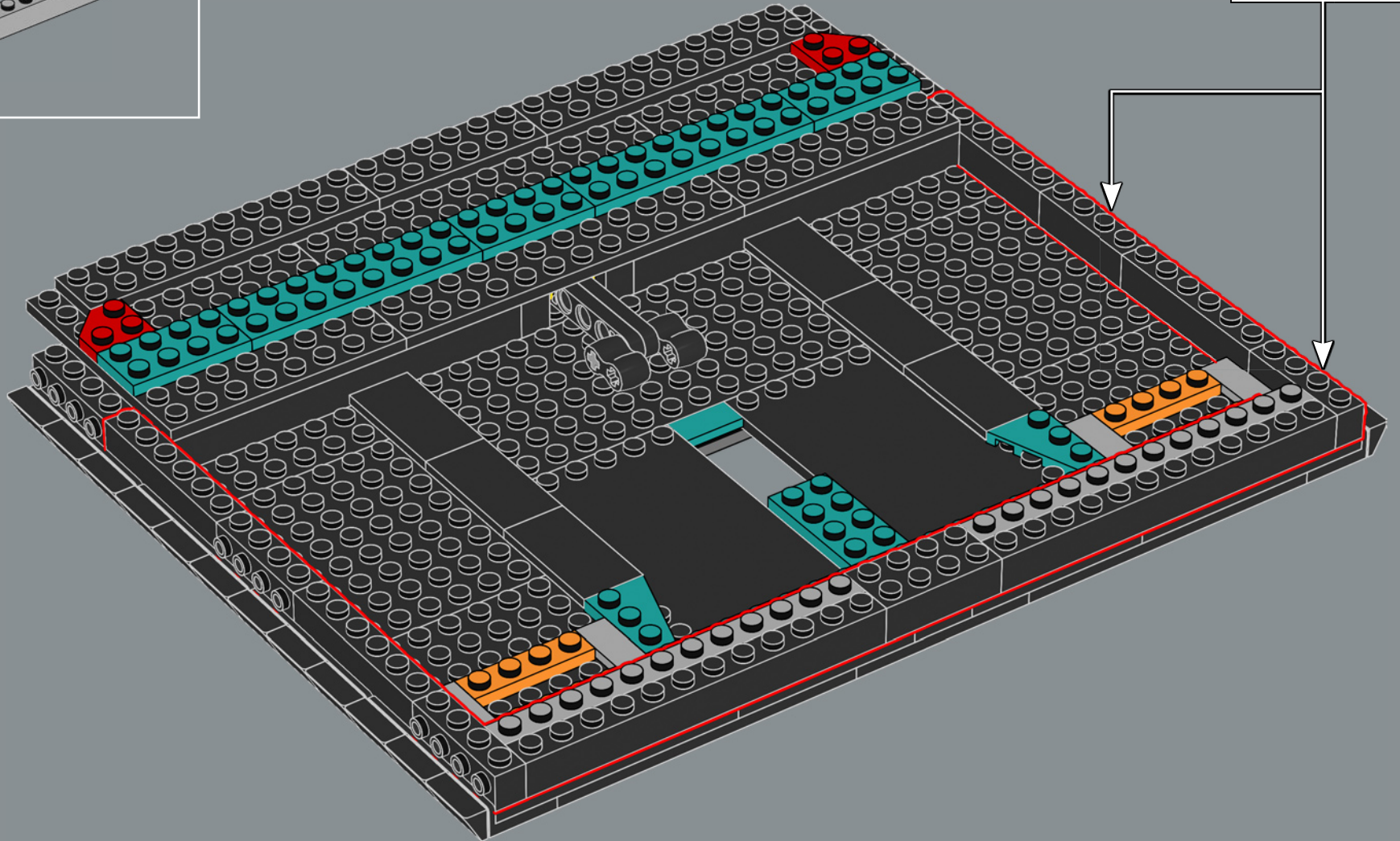

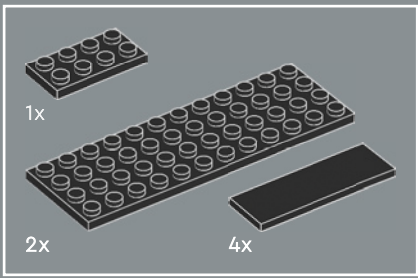

17

1

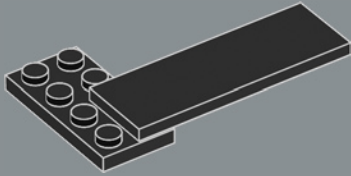

2

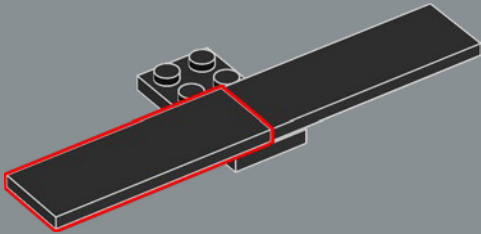

3

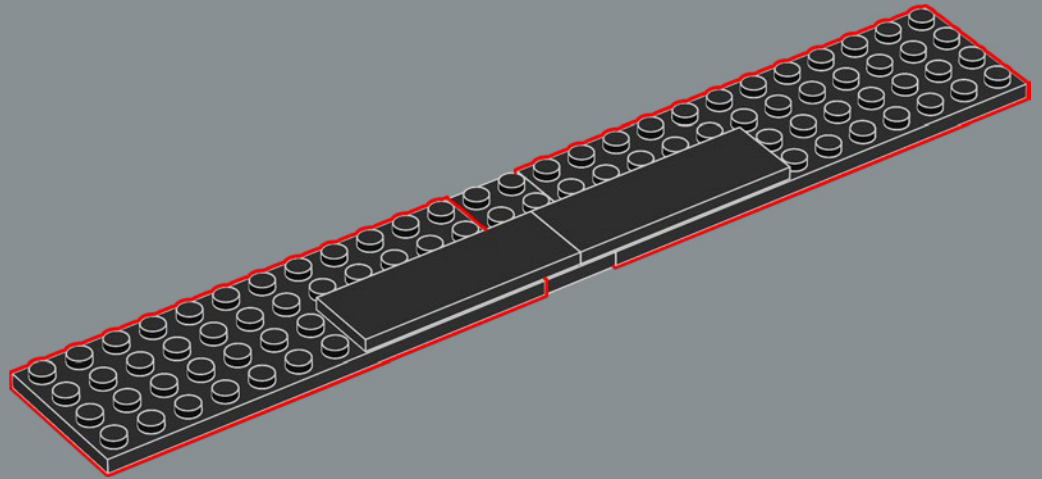

4

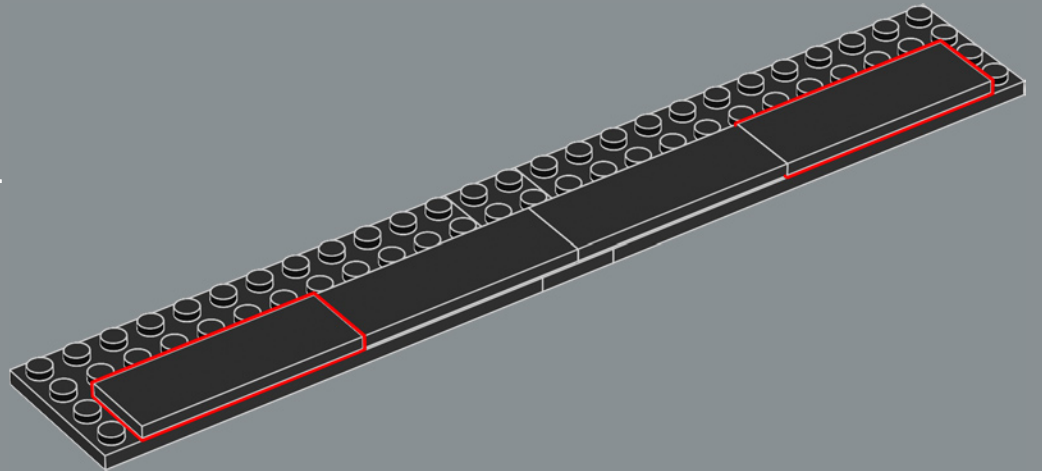

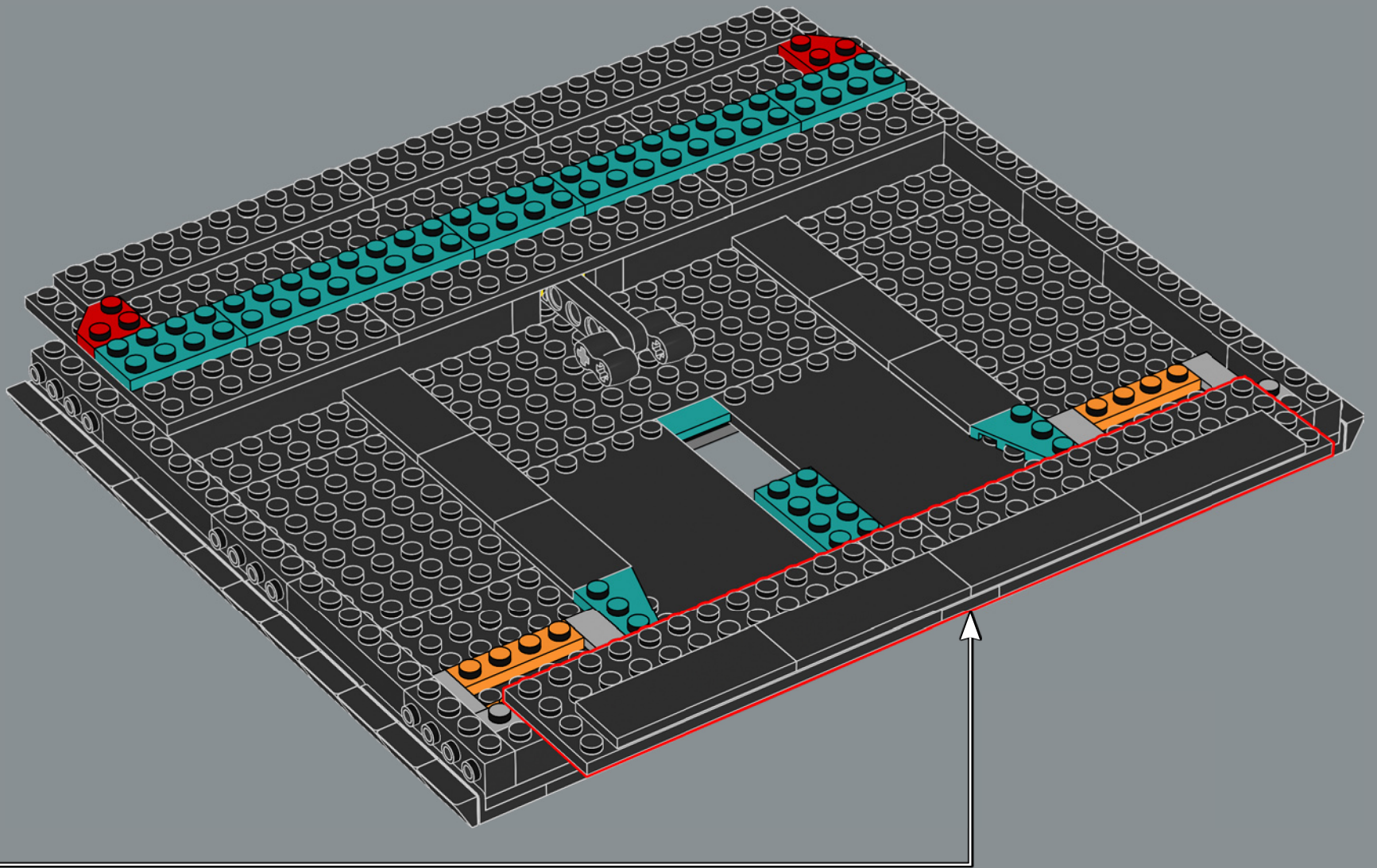

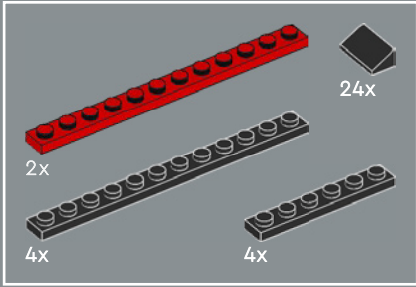
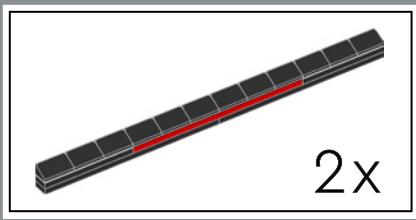

18

1

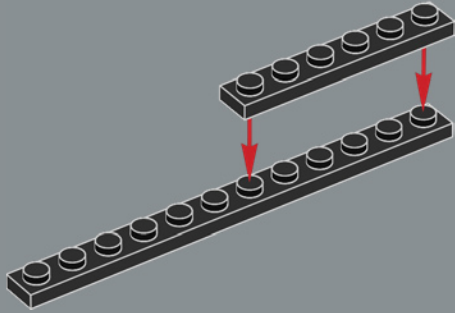

2

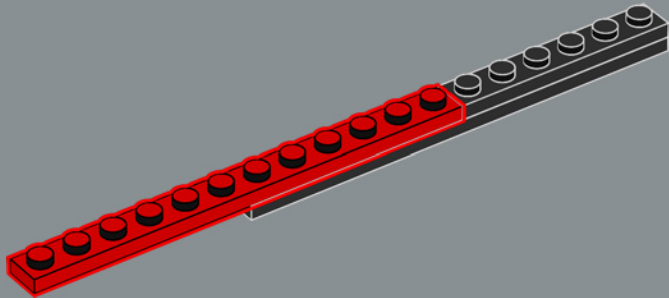

3

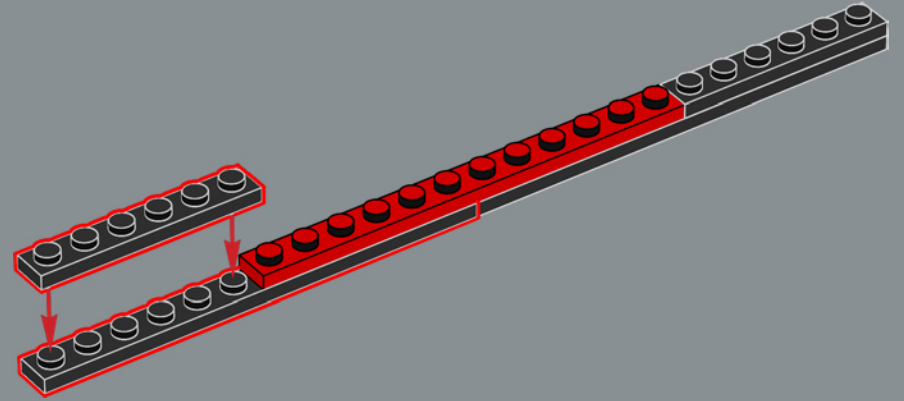

4

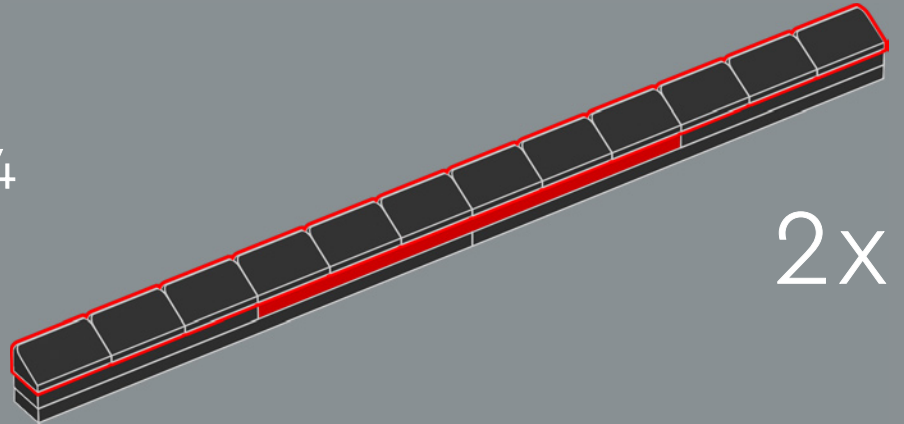

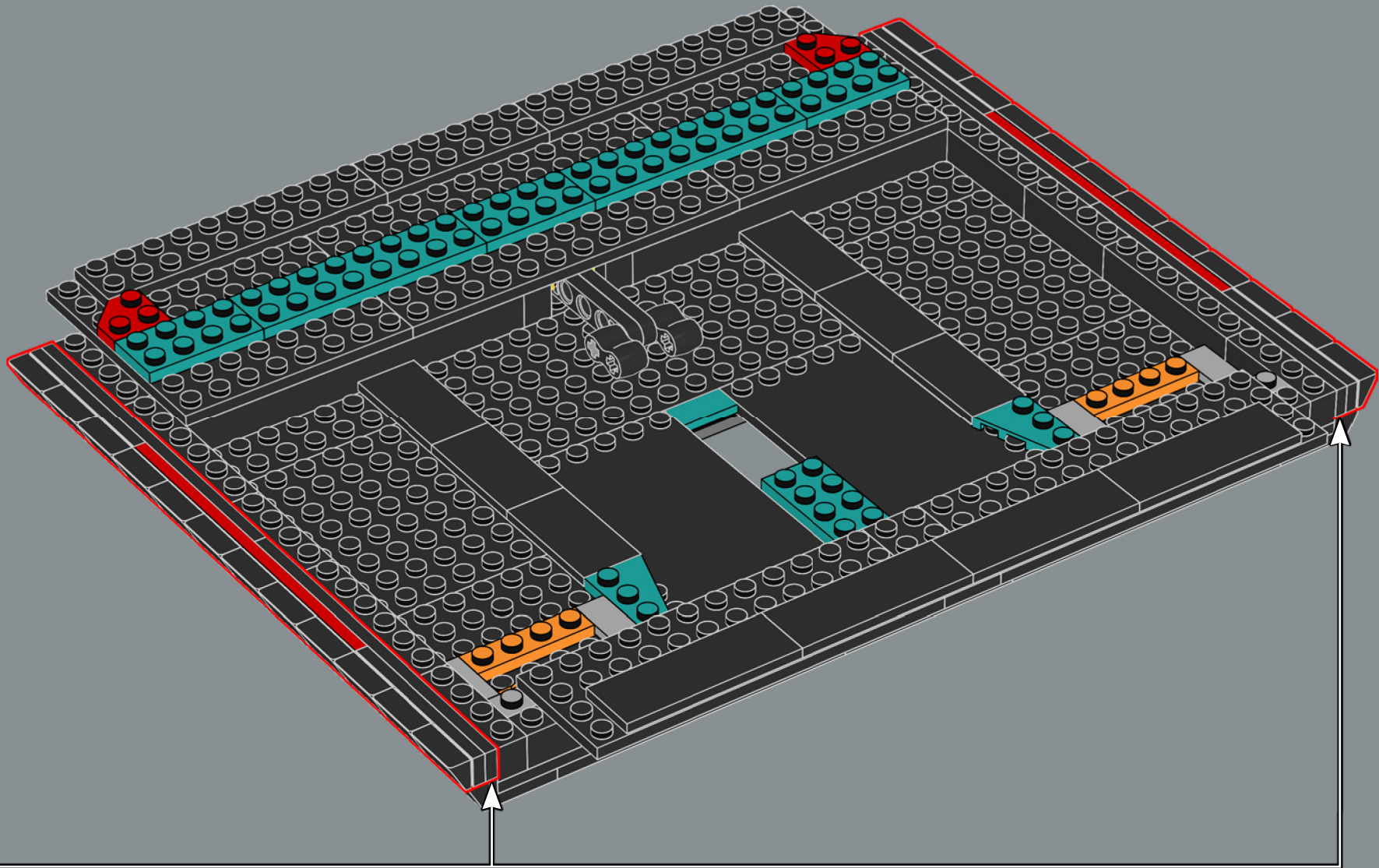

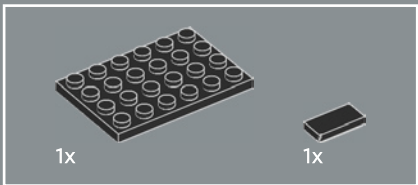
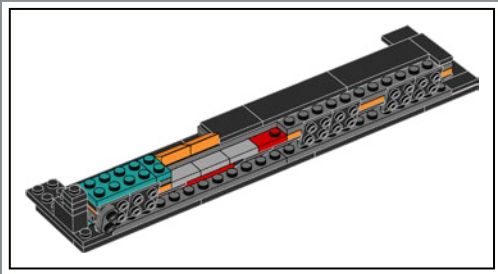

19

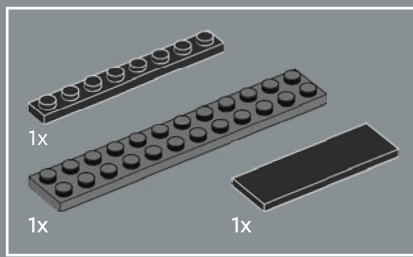
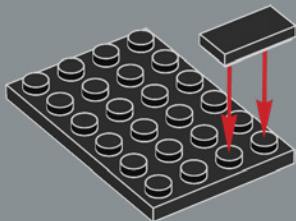

20

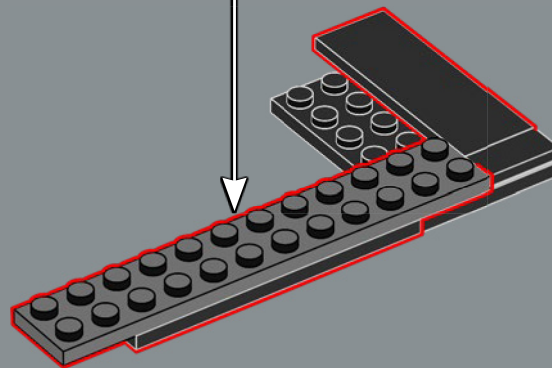
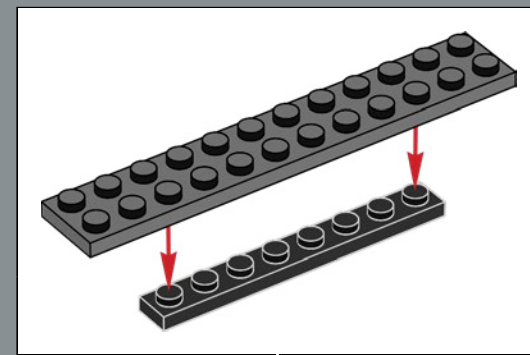

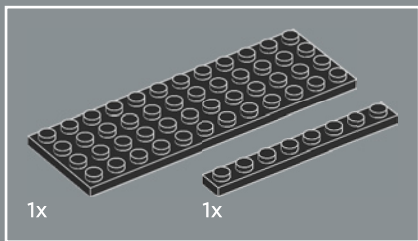

21

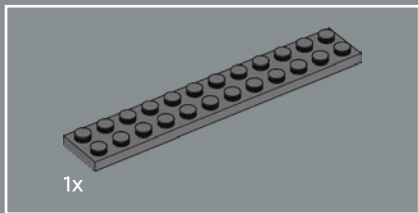
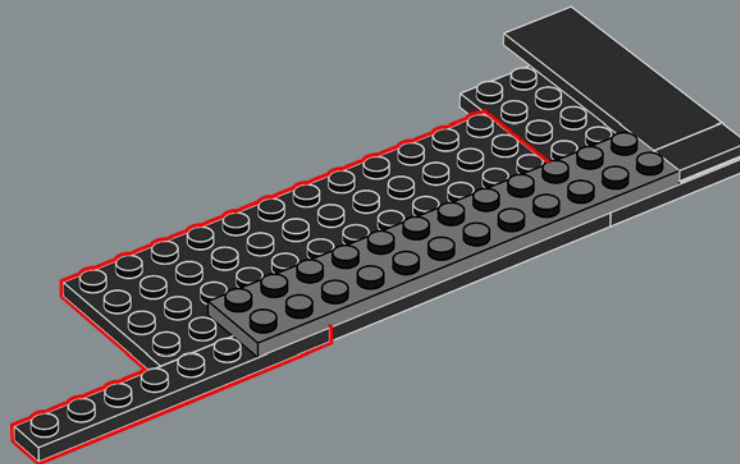

22

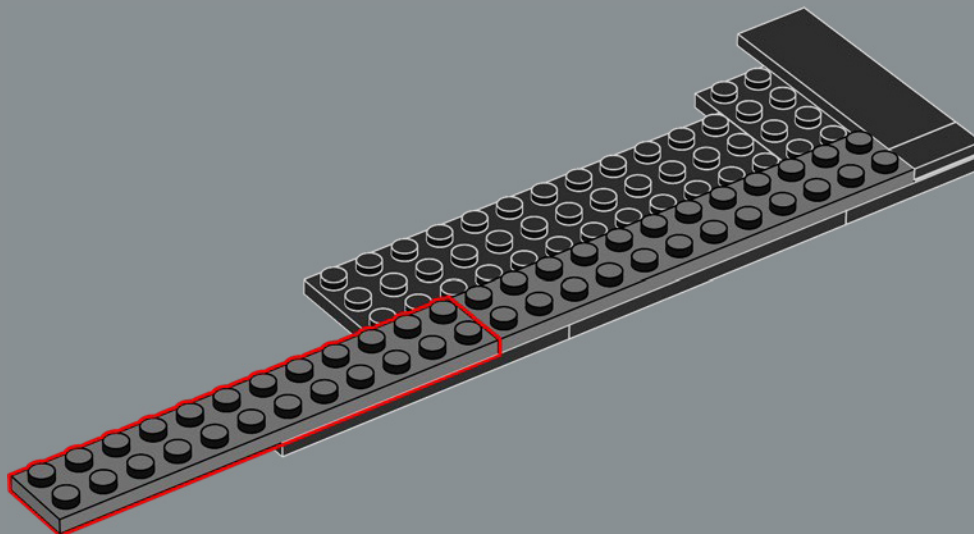

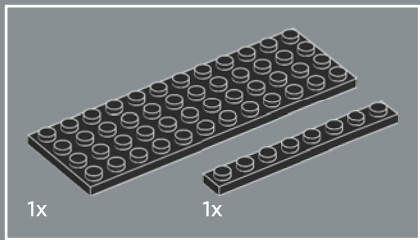

23

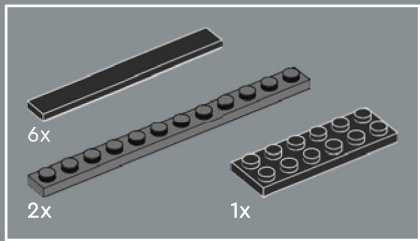
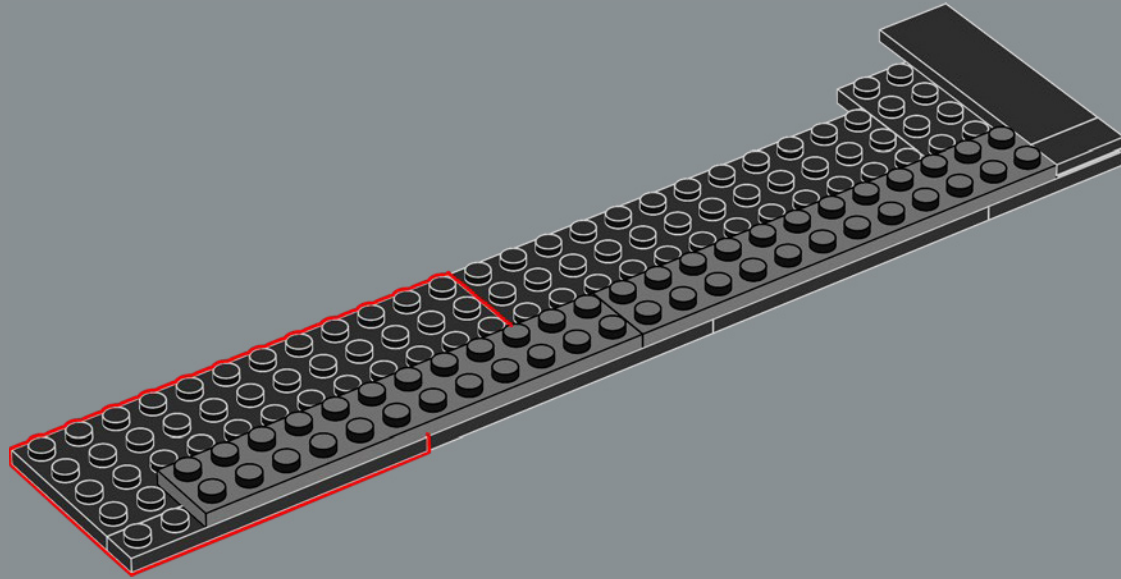

24

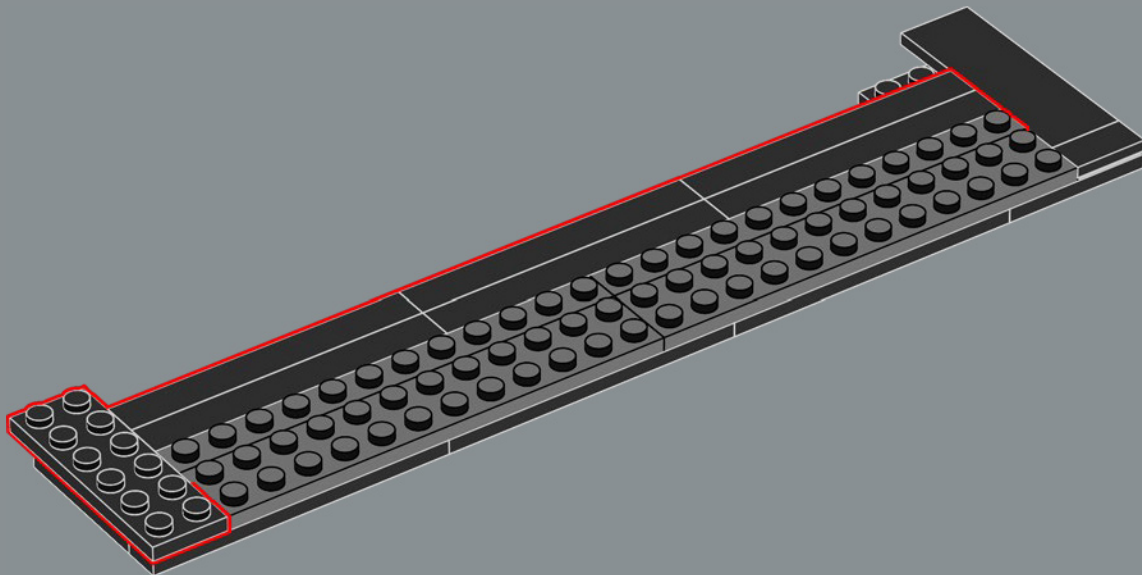

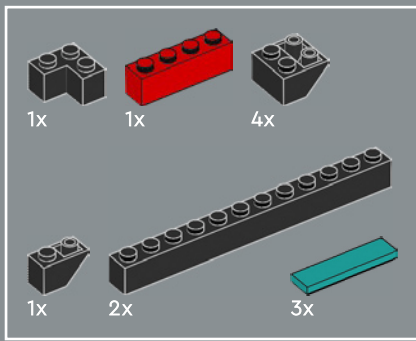

25

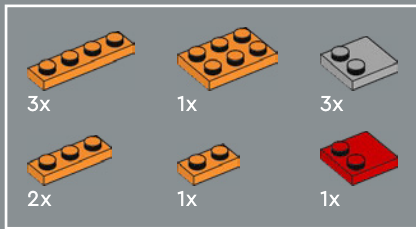
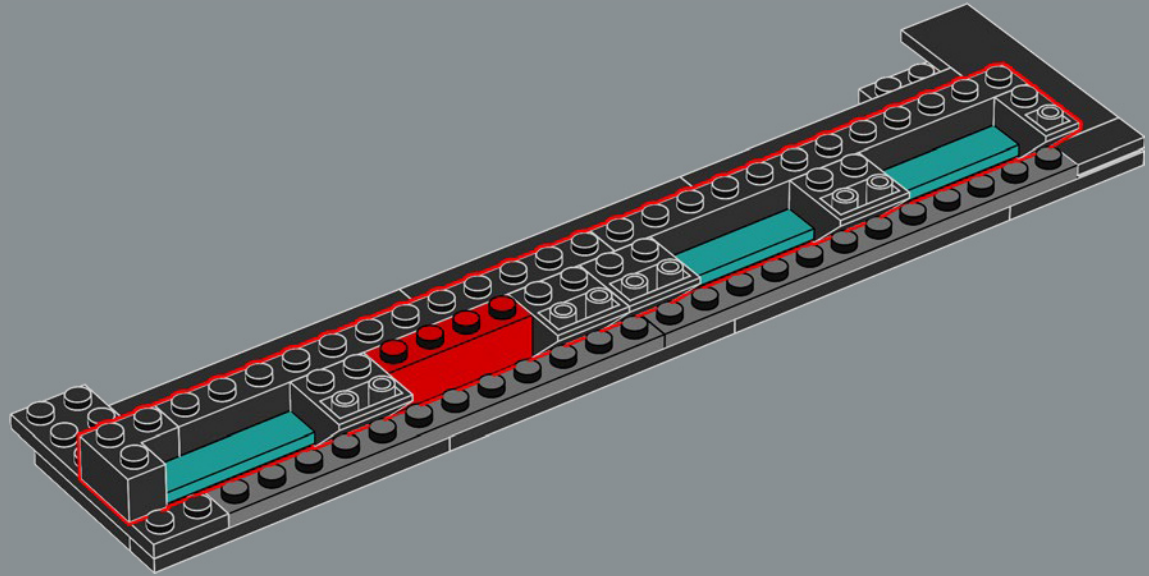

26

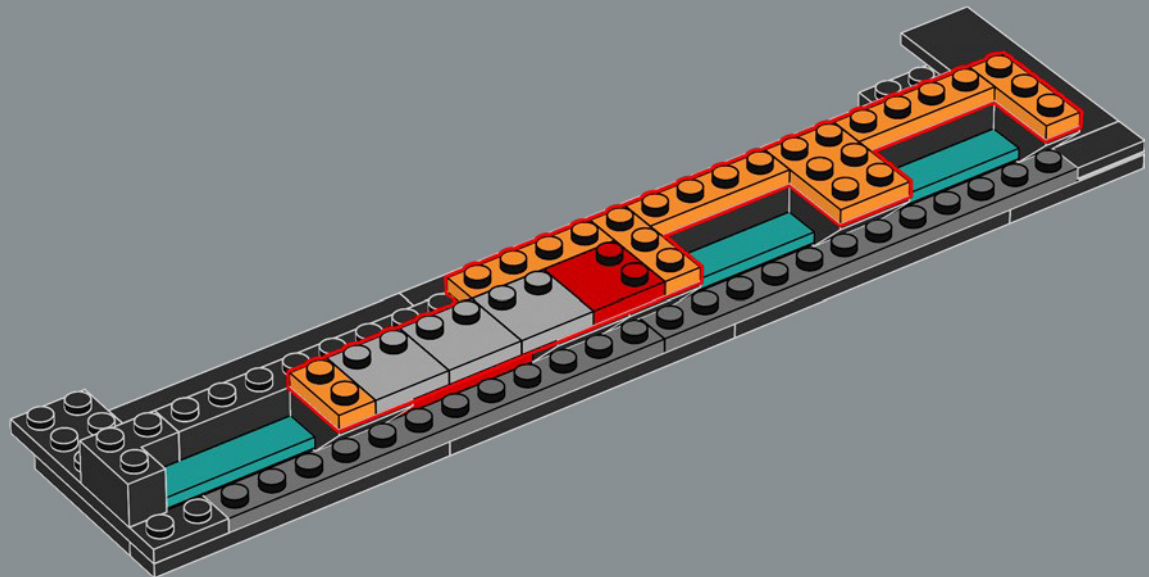

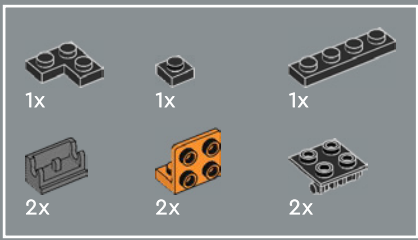

27

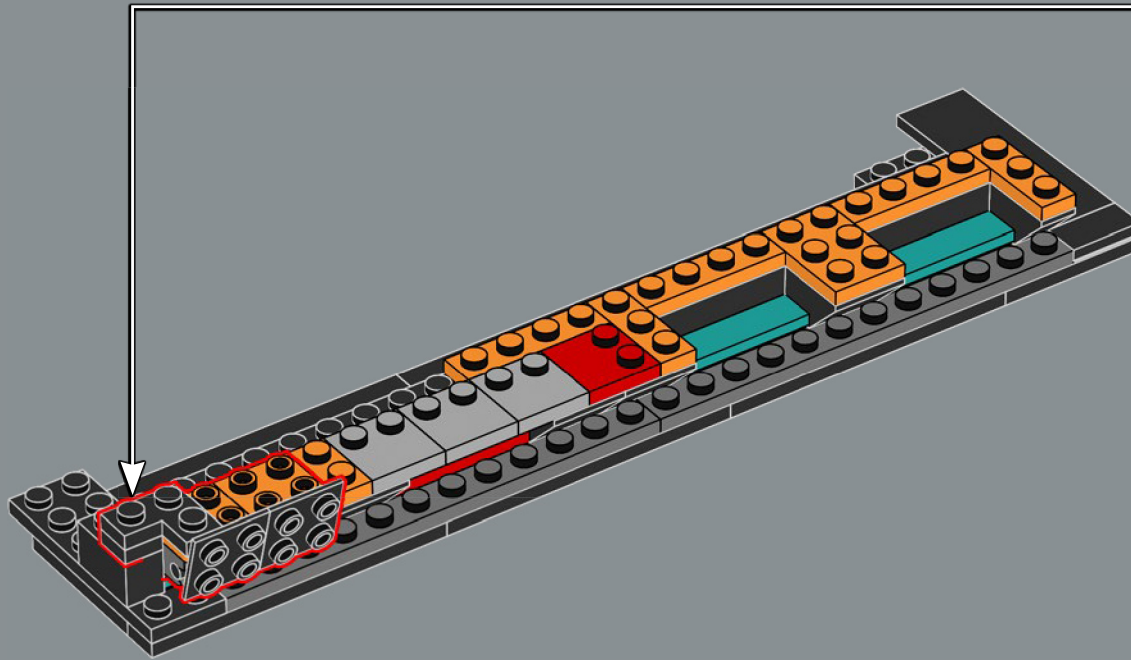
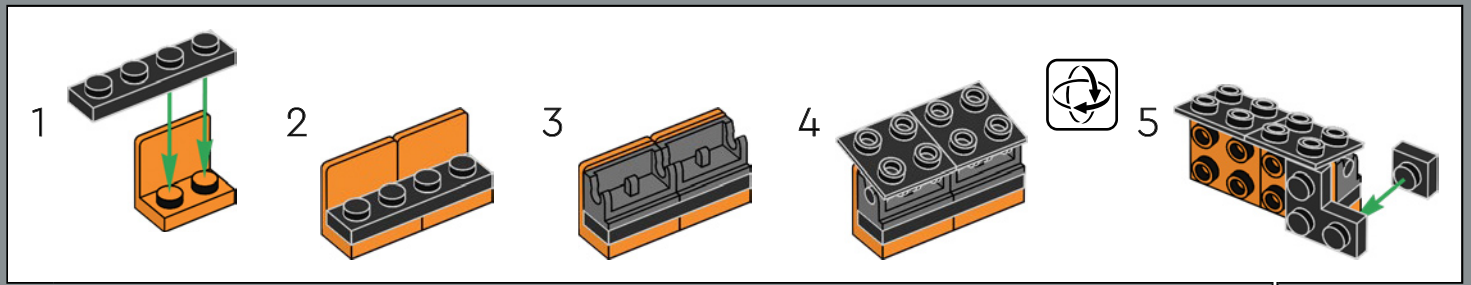

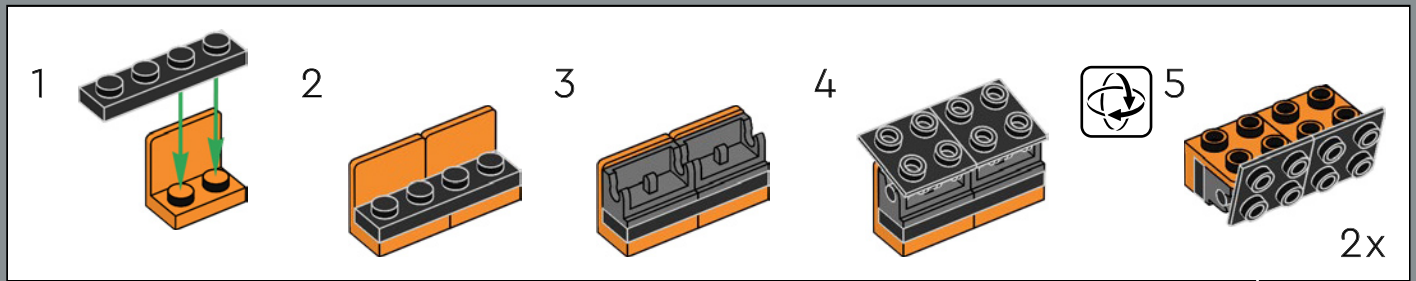
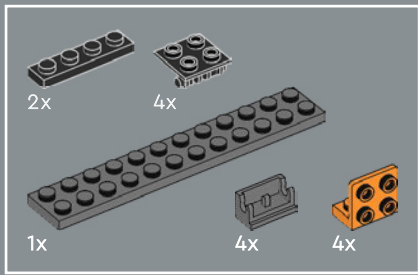

28

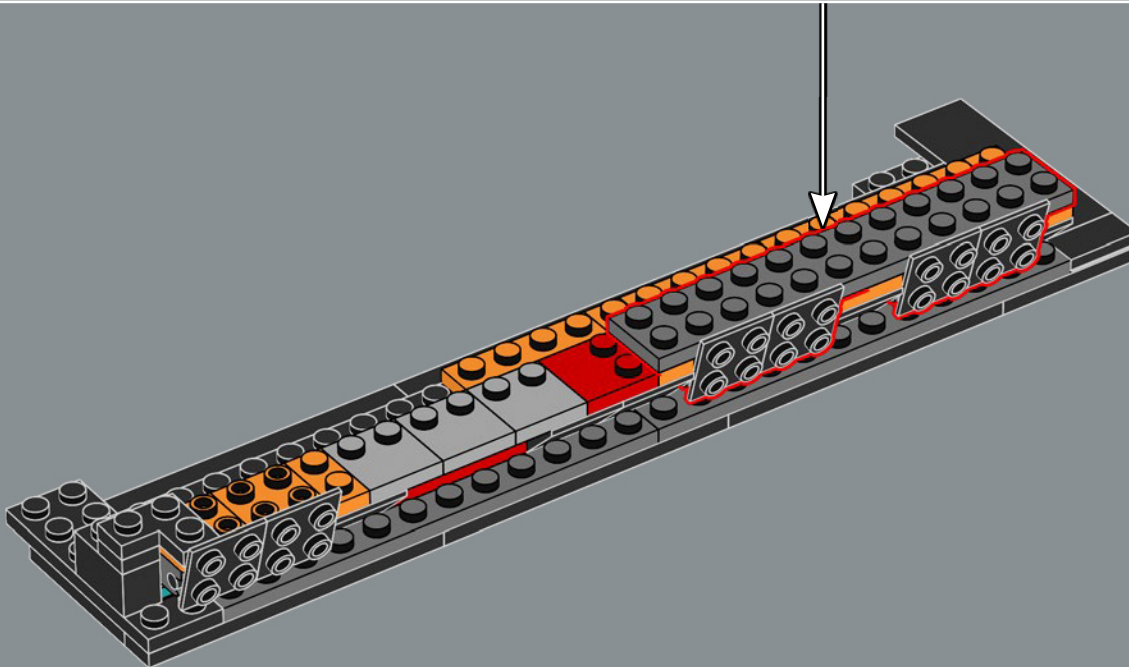
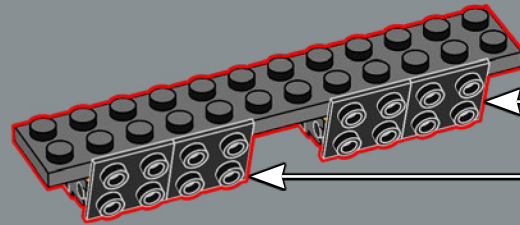

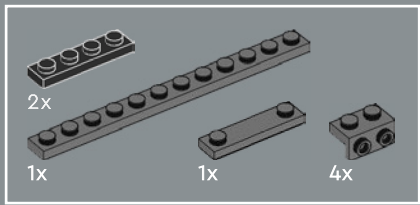

29

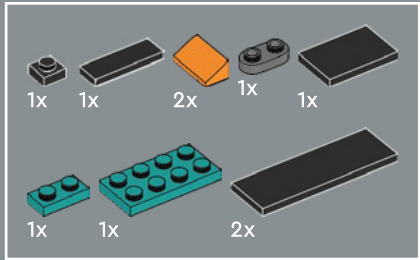
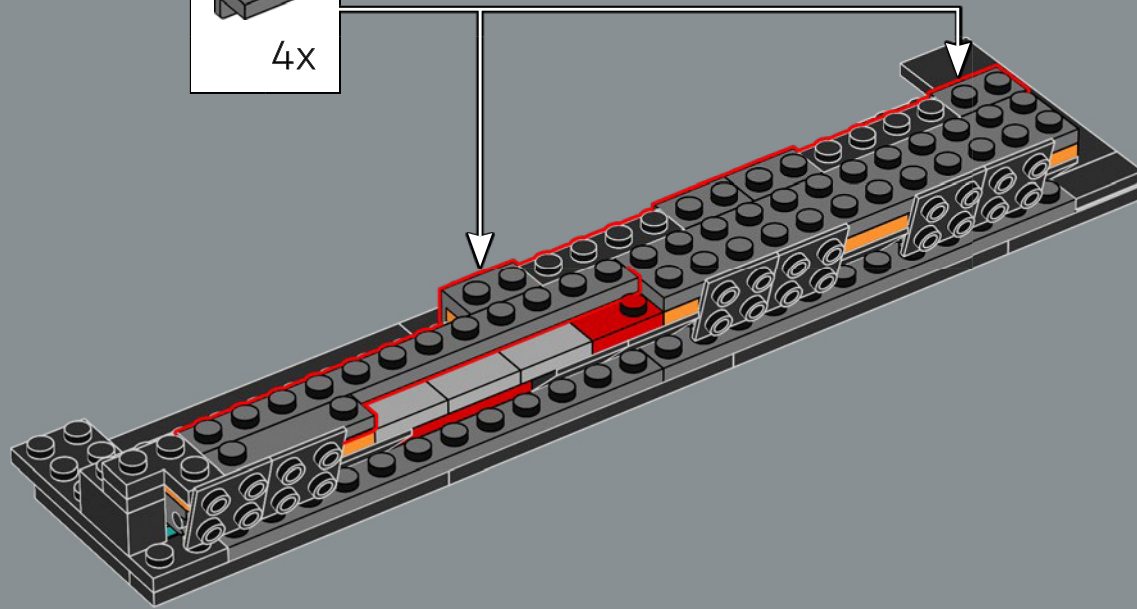
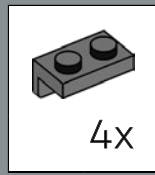

30

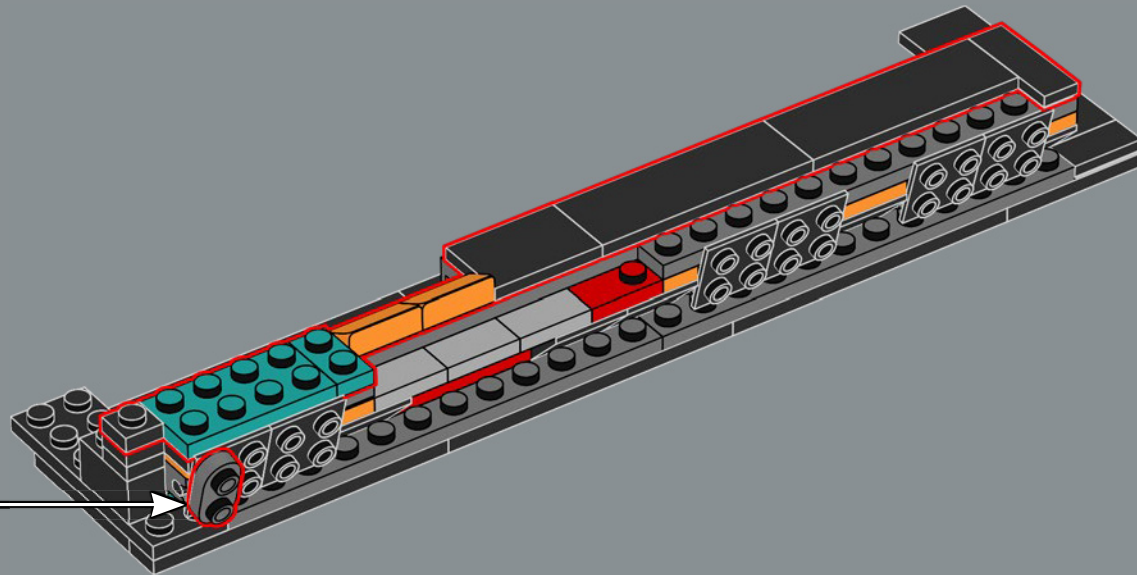

31

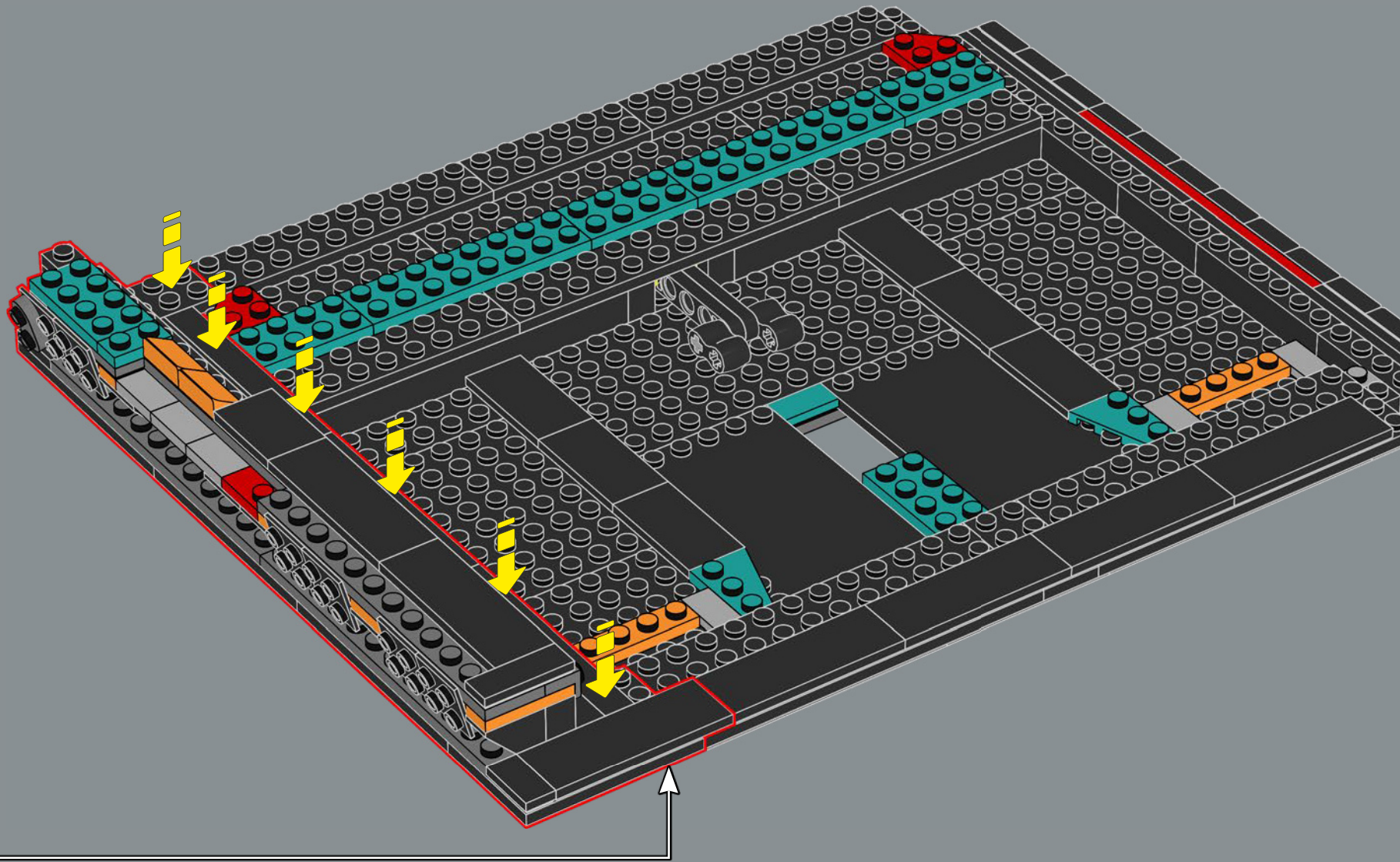

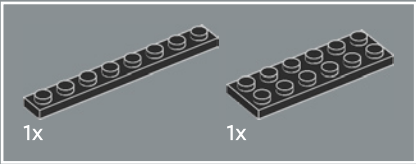
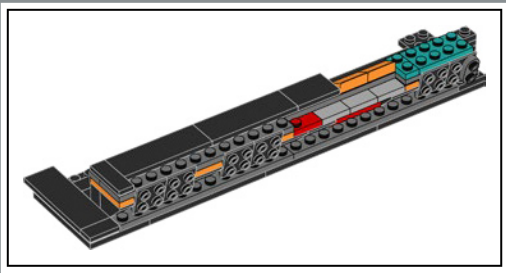

32

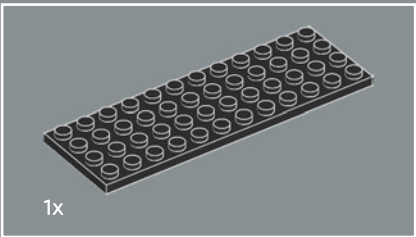
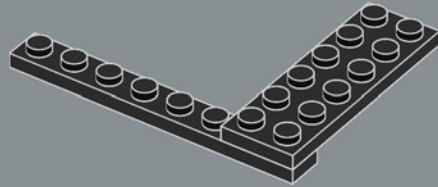

33

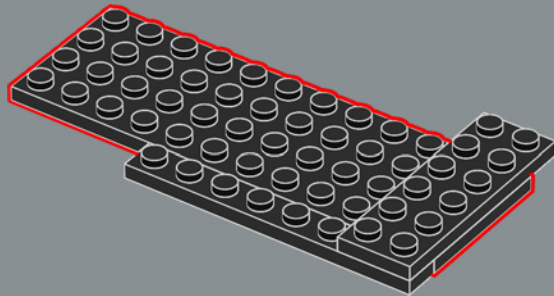

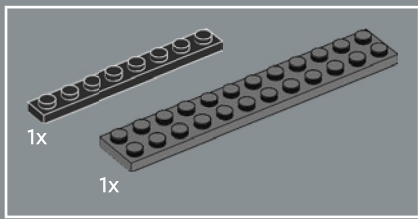

34

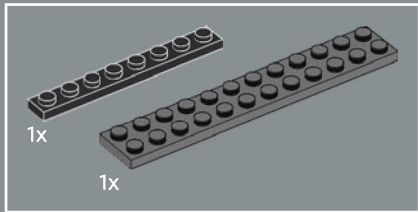
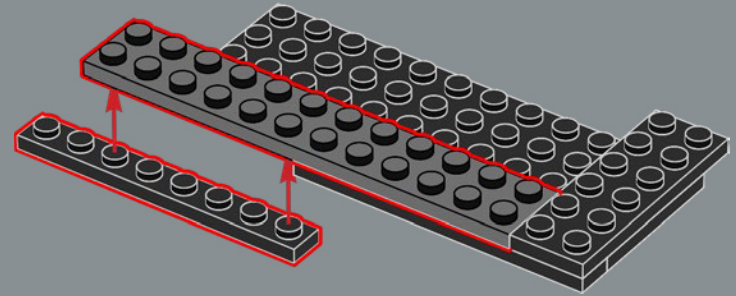

35

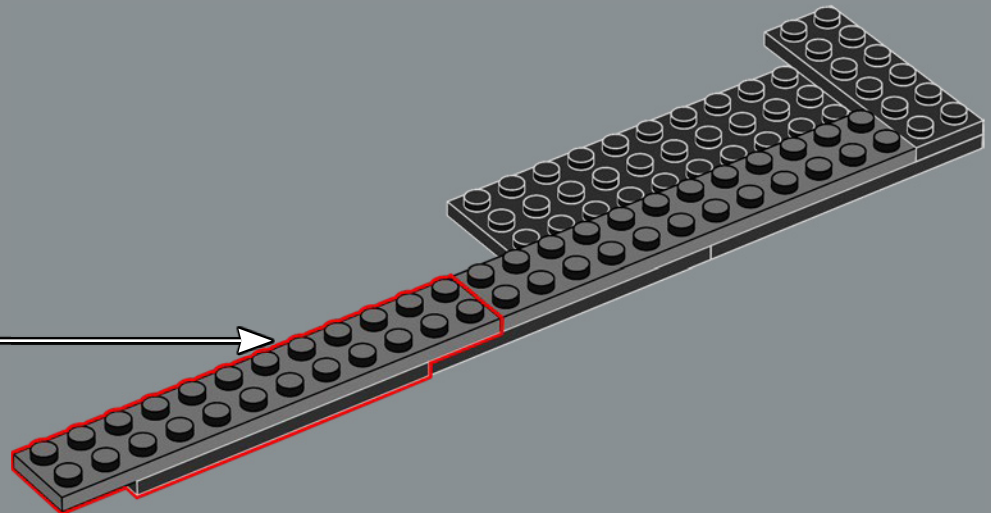
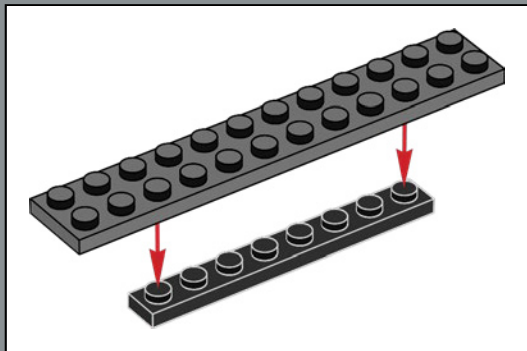

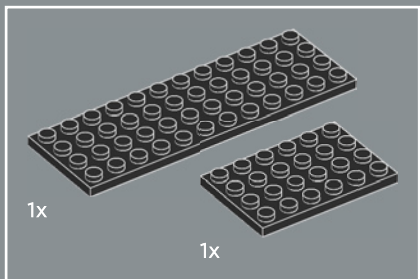

36

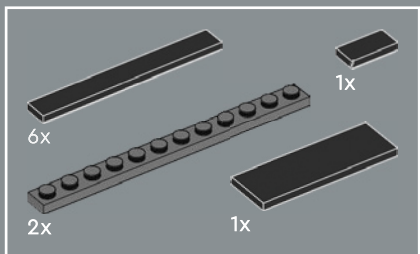
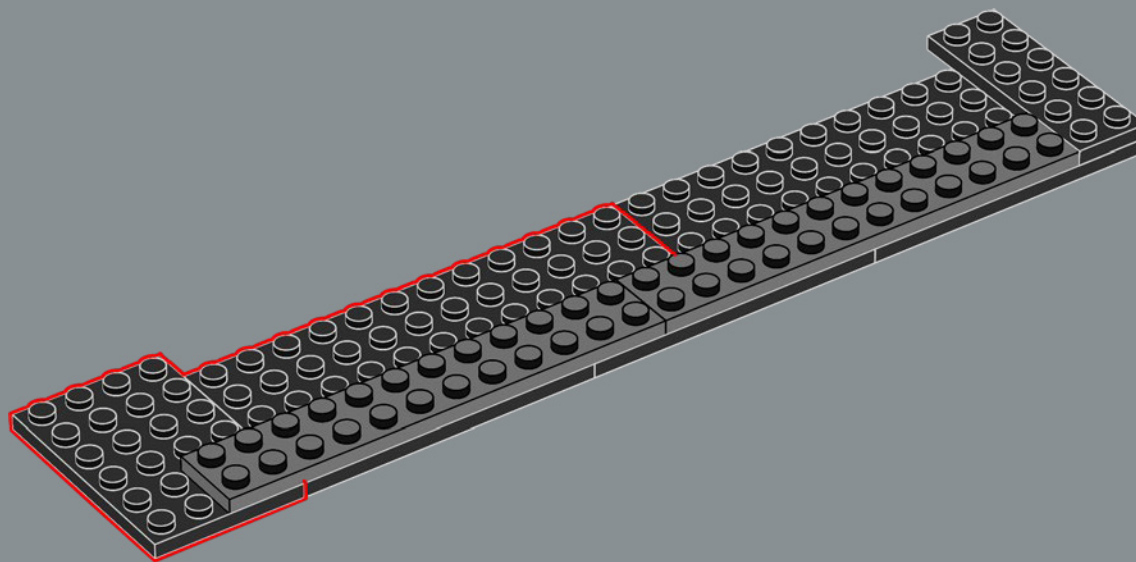

37

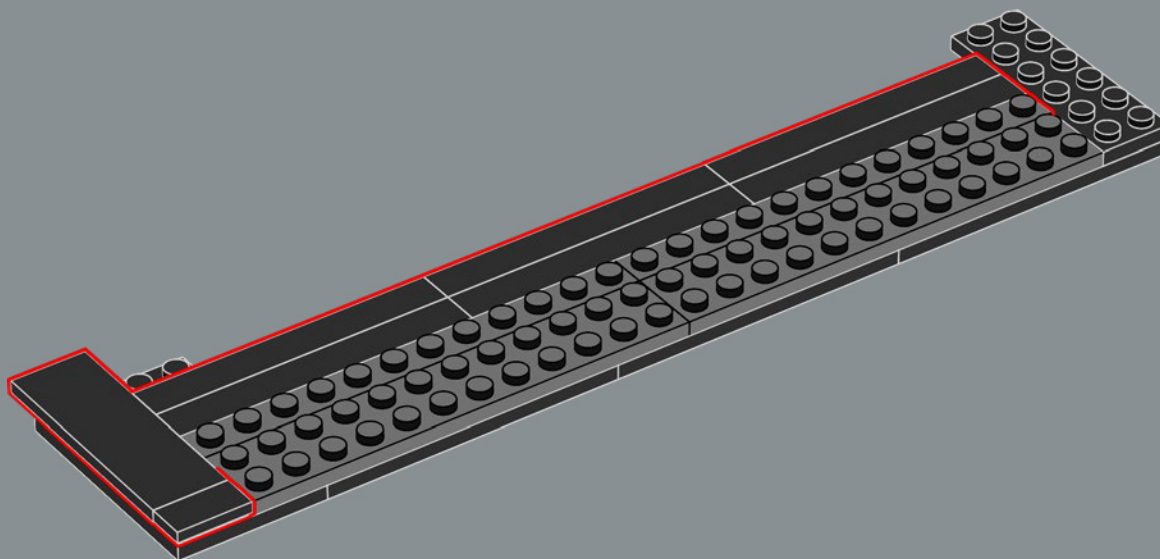

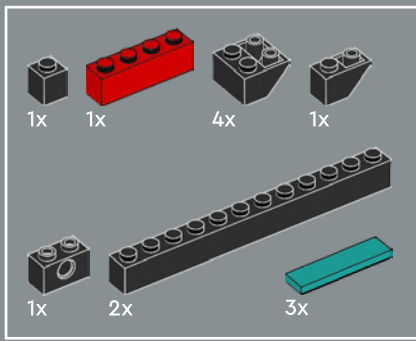

38

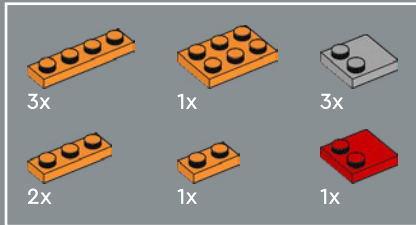
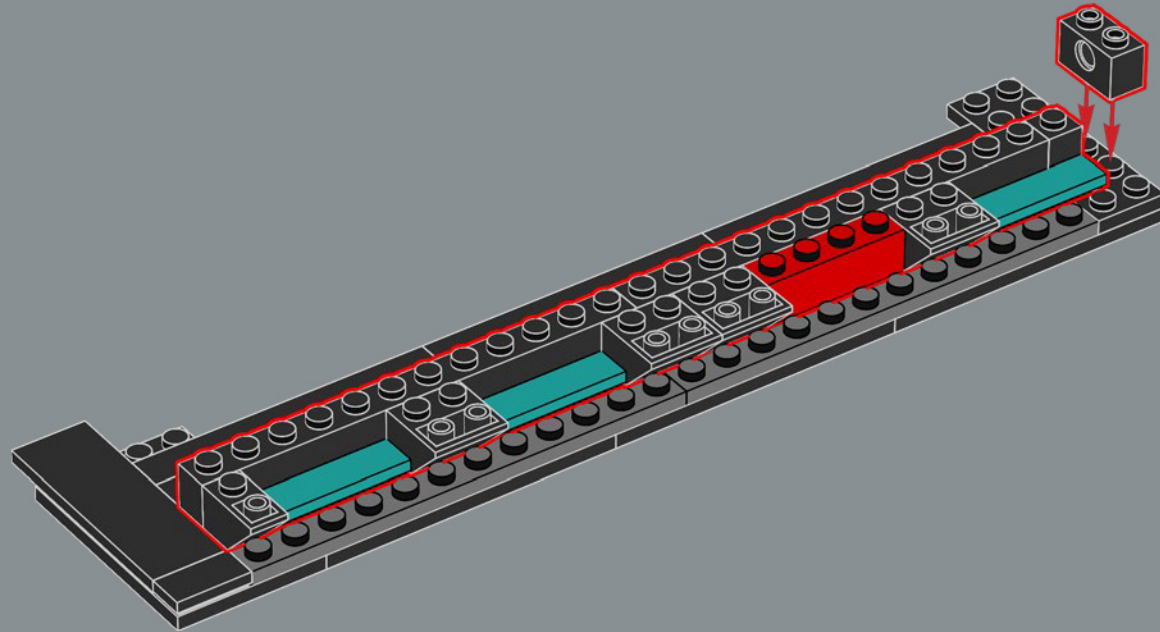

39

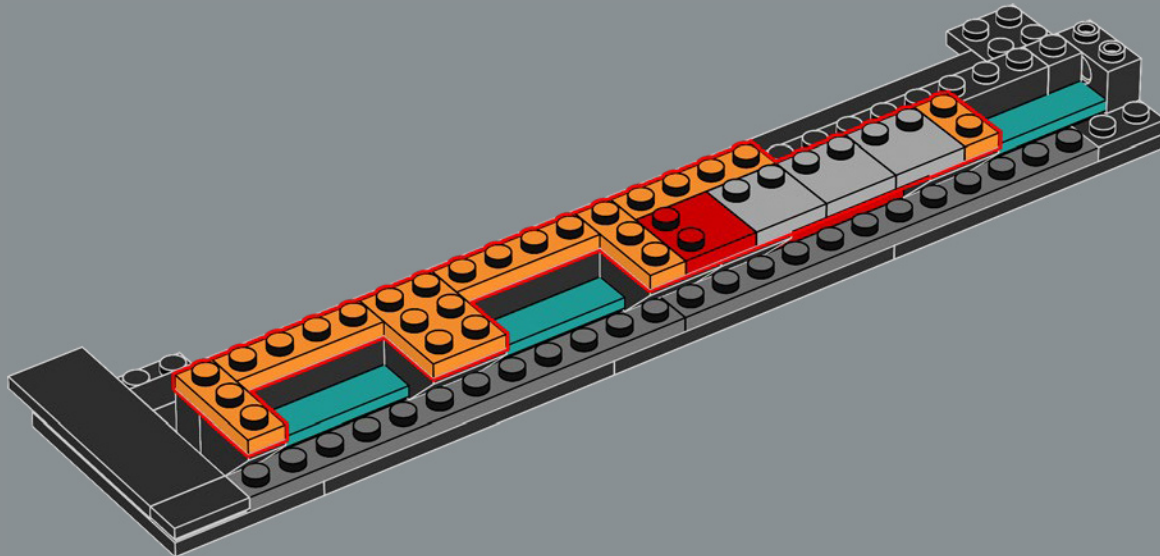

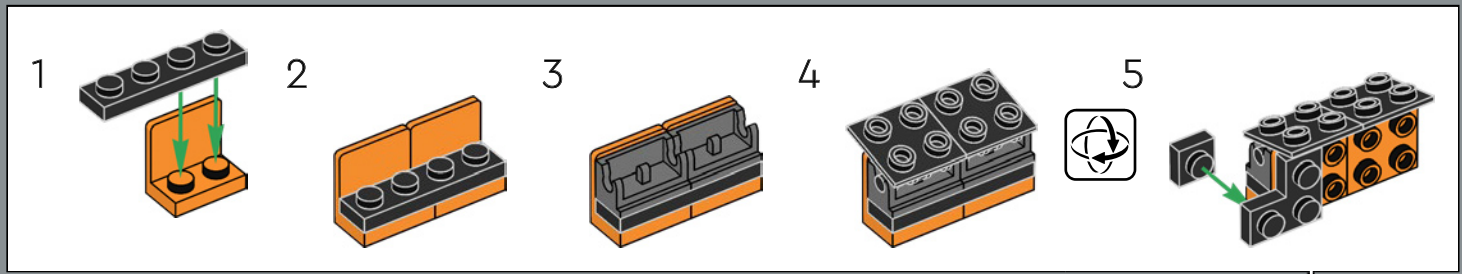
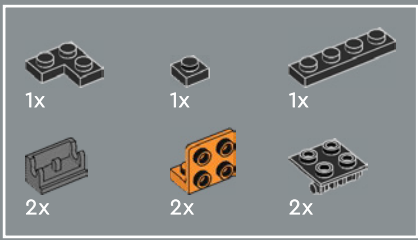

40

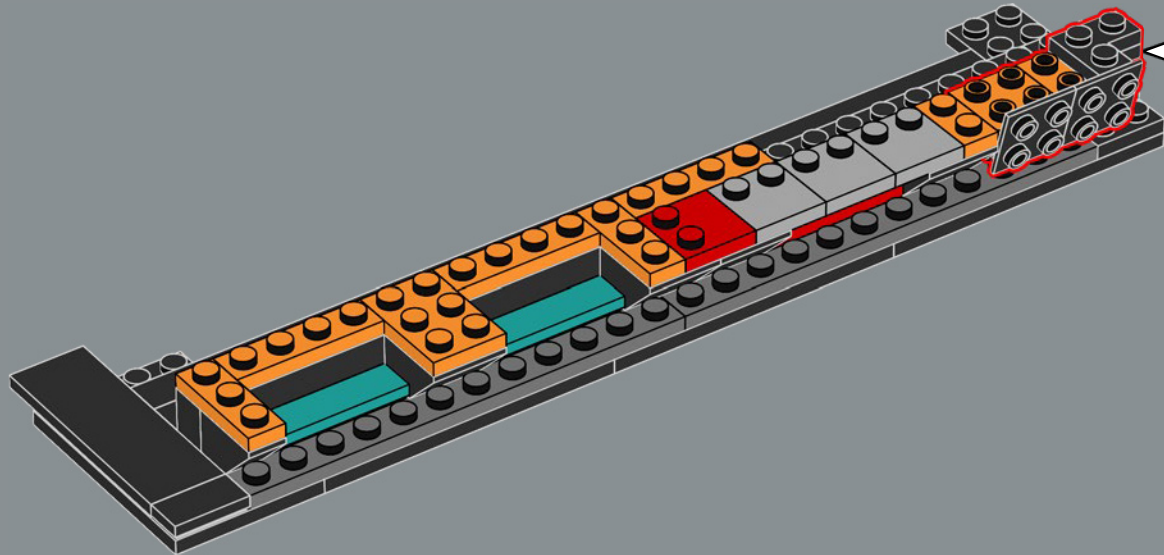

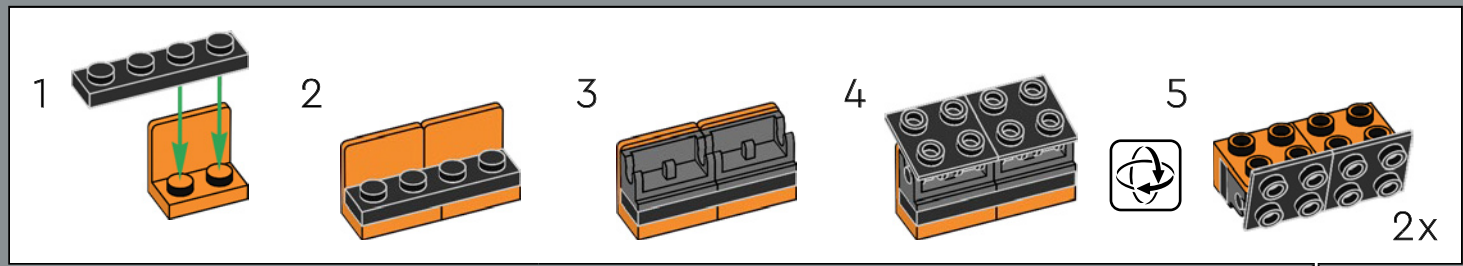
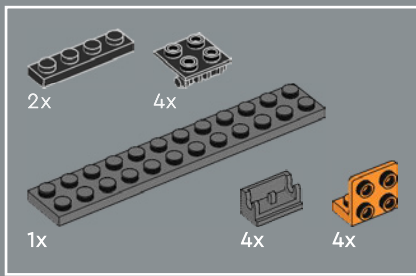

41

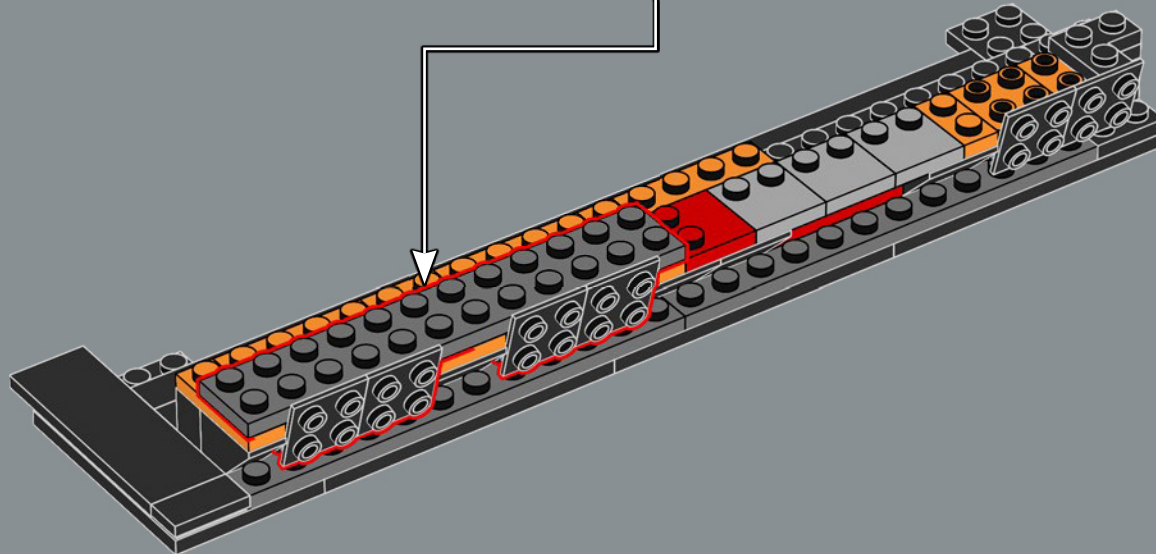
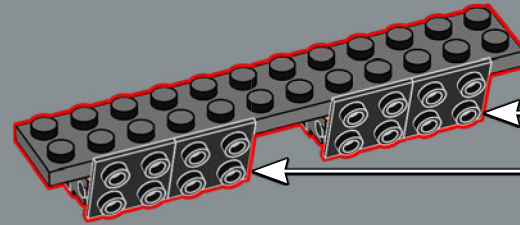

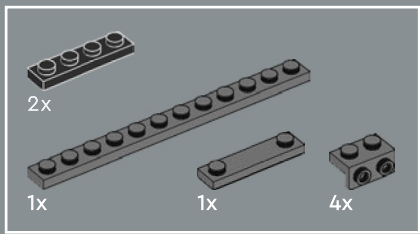

42

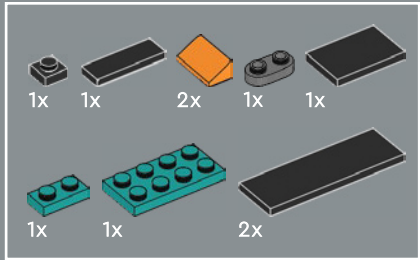
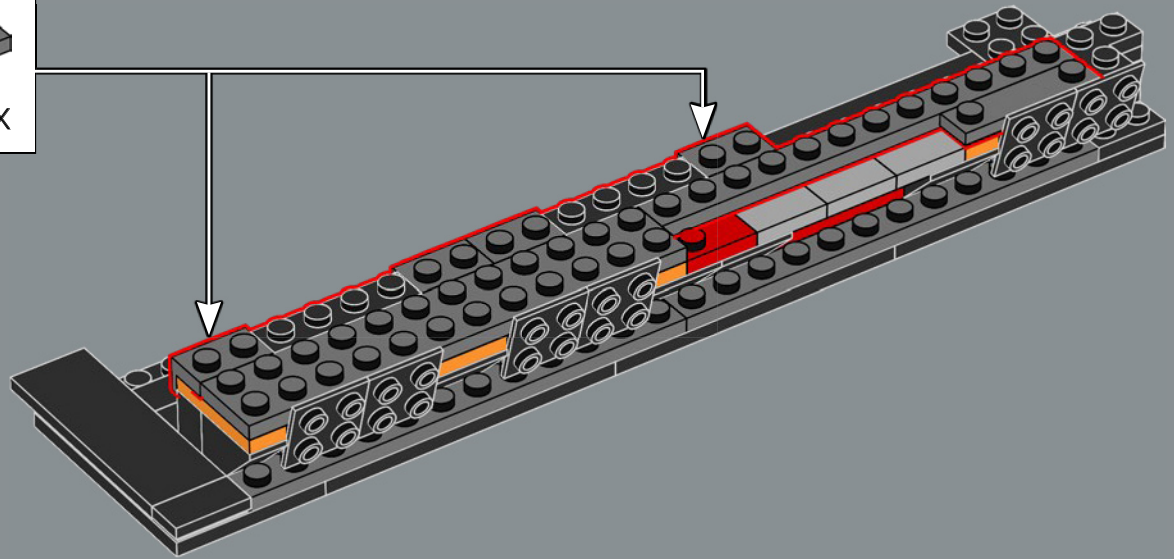
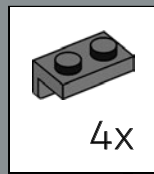

43

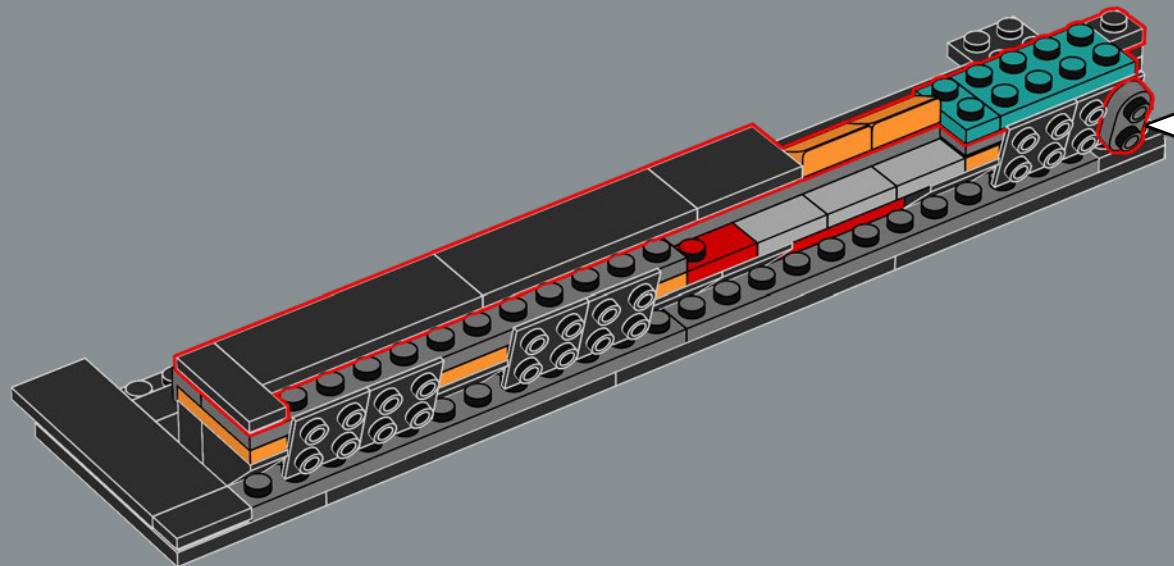

44

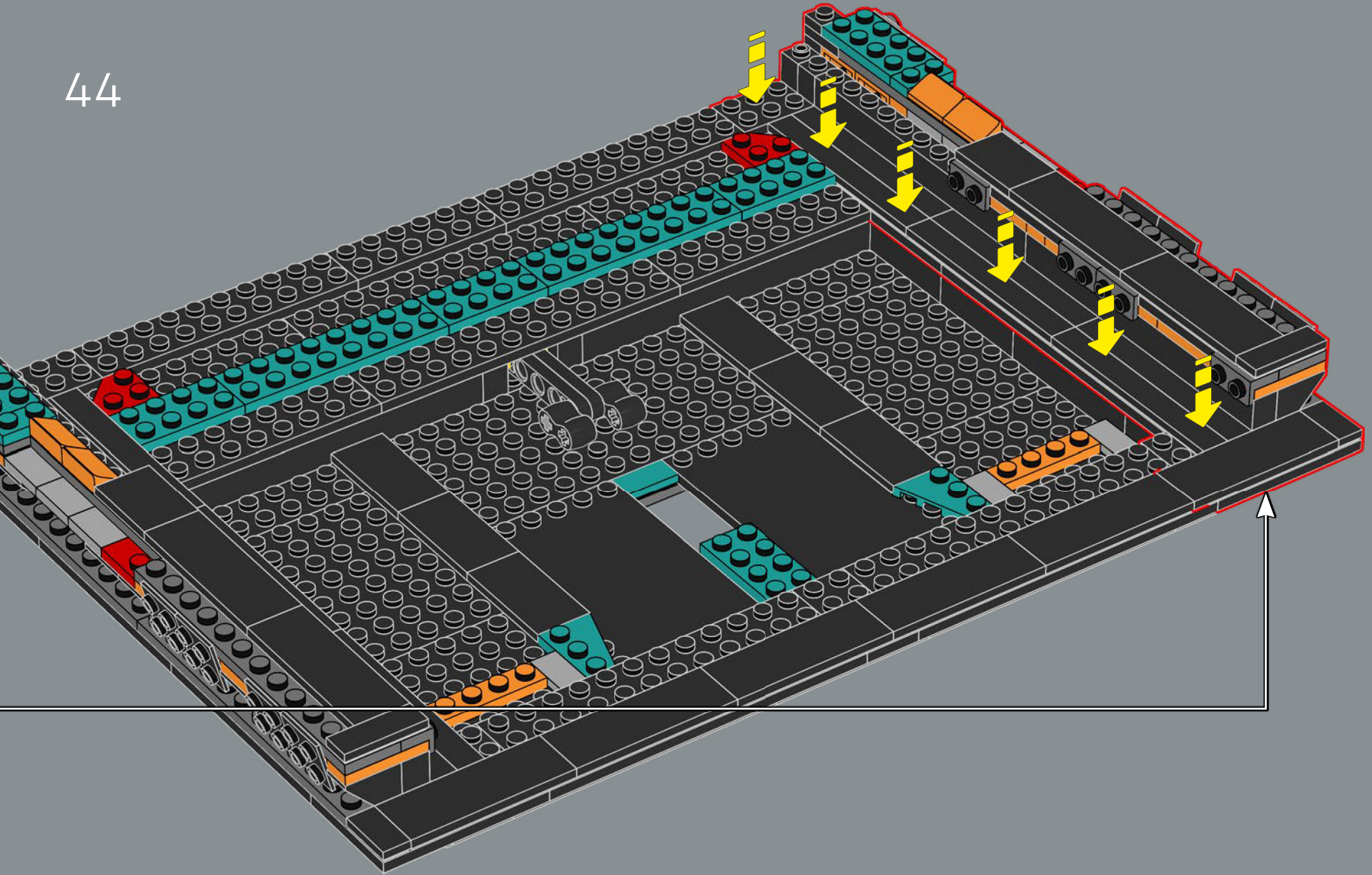



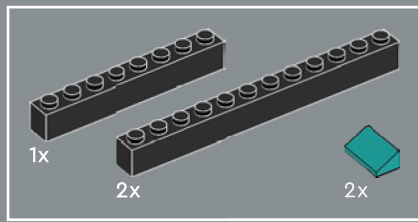

45

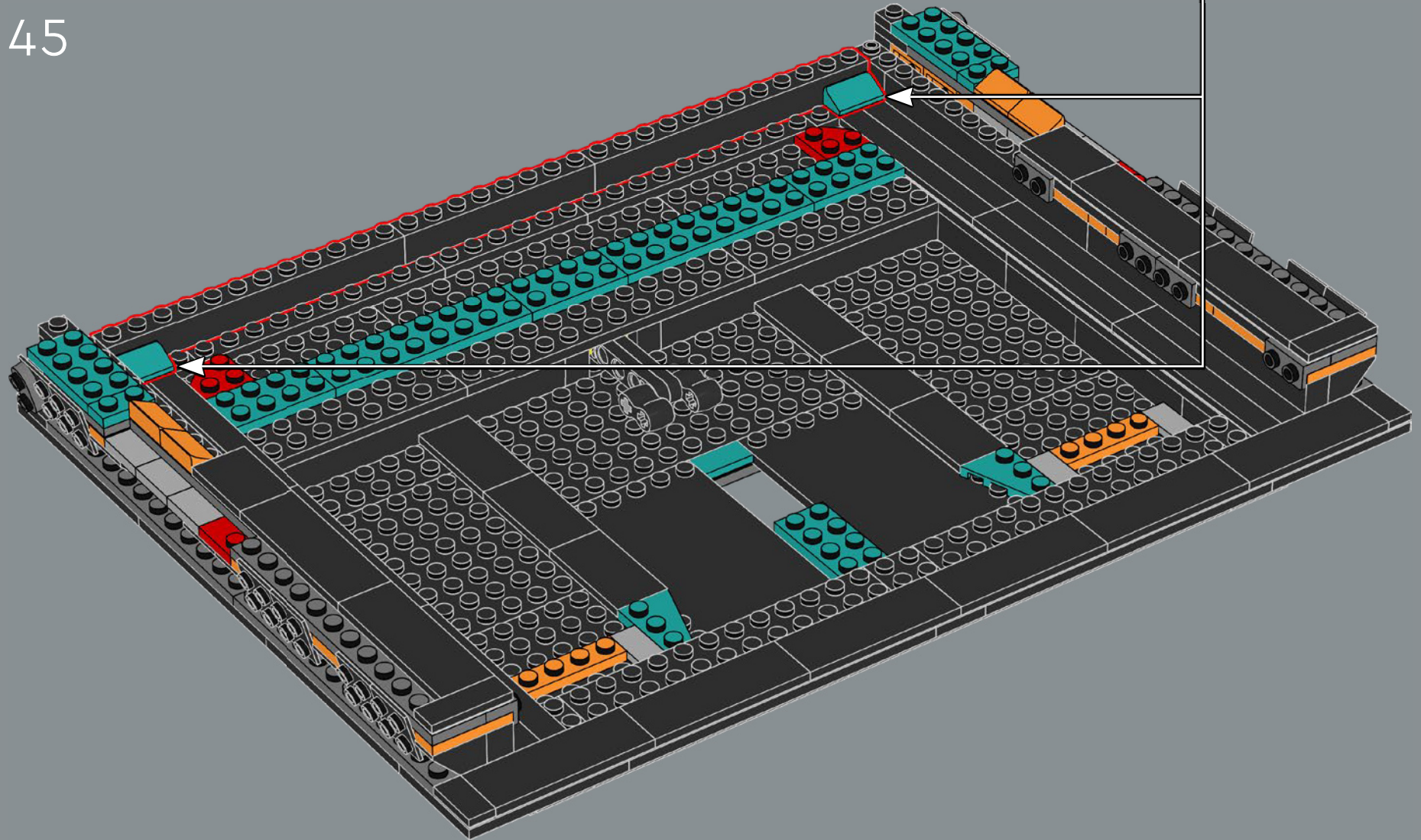
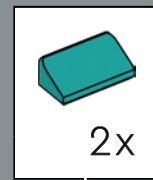

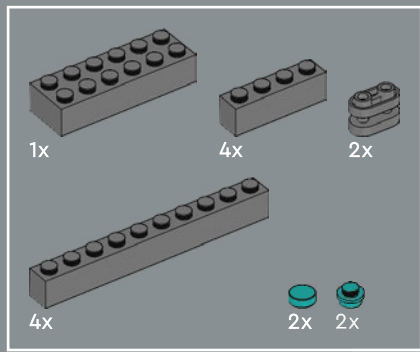

46

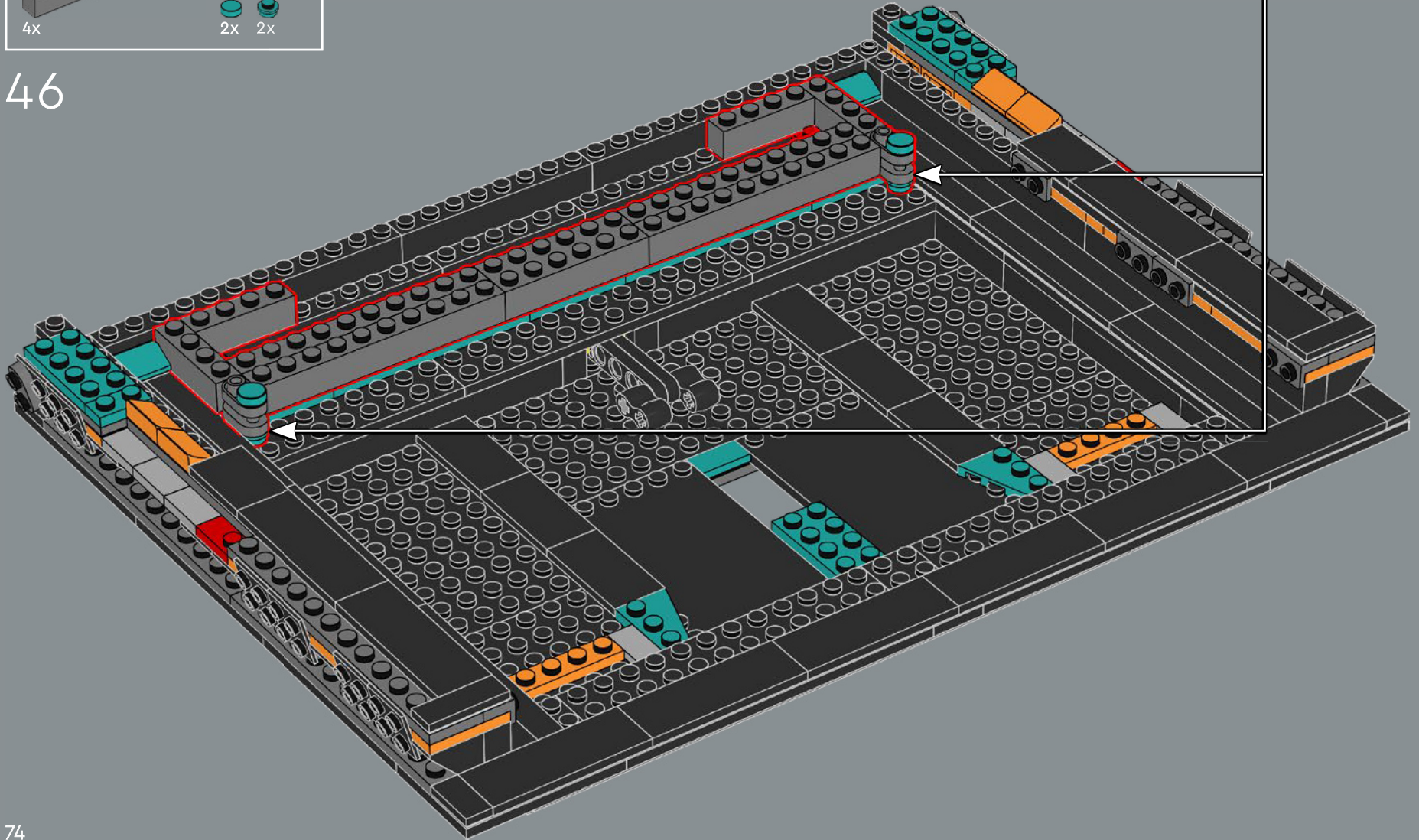
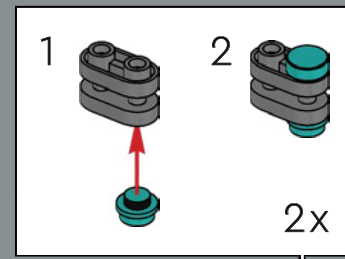

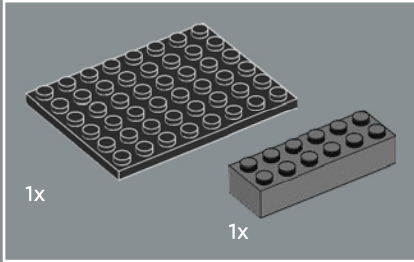
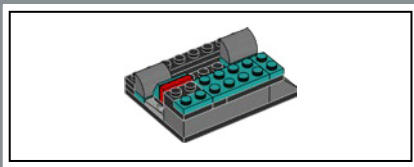

47

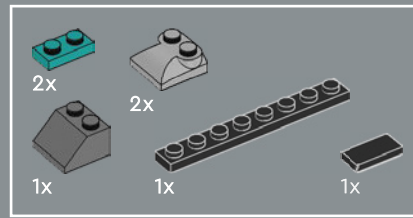
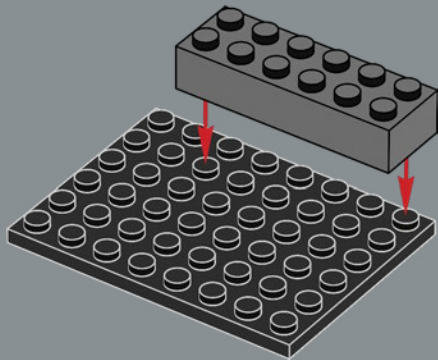

48

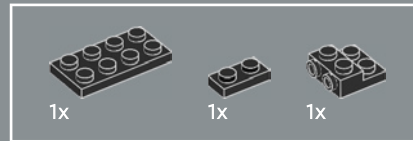
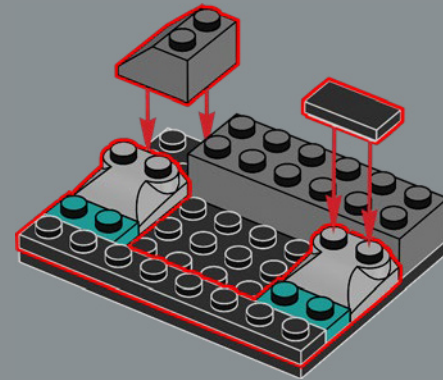

49

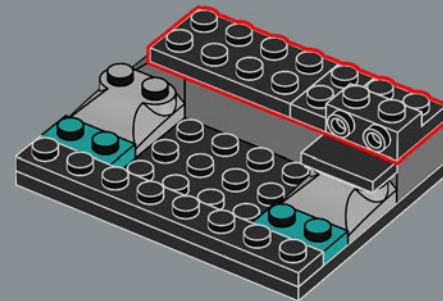

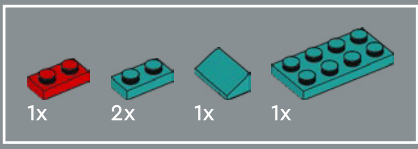

50

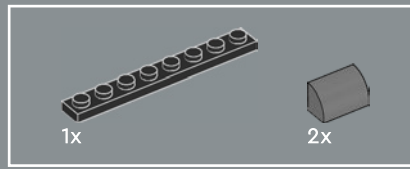
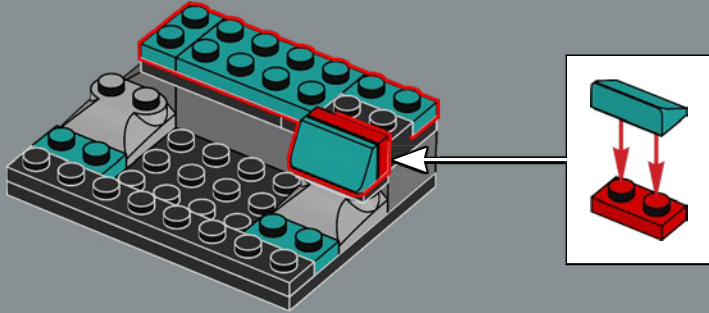

51

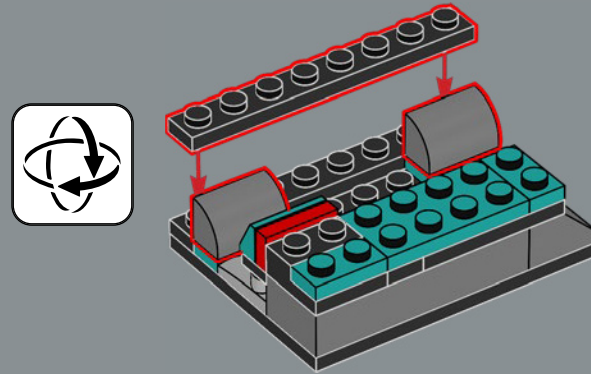

52

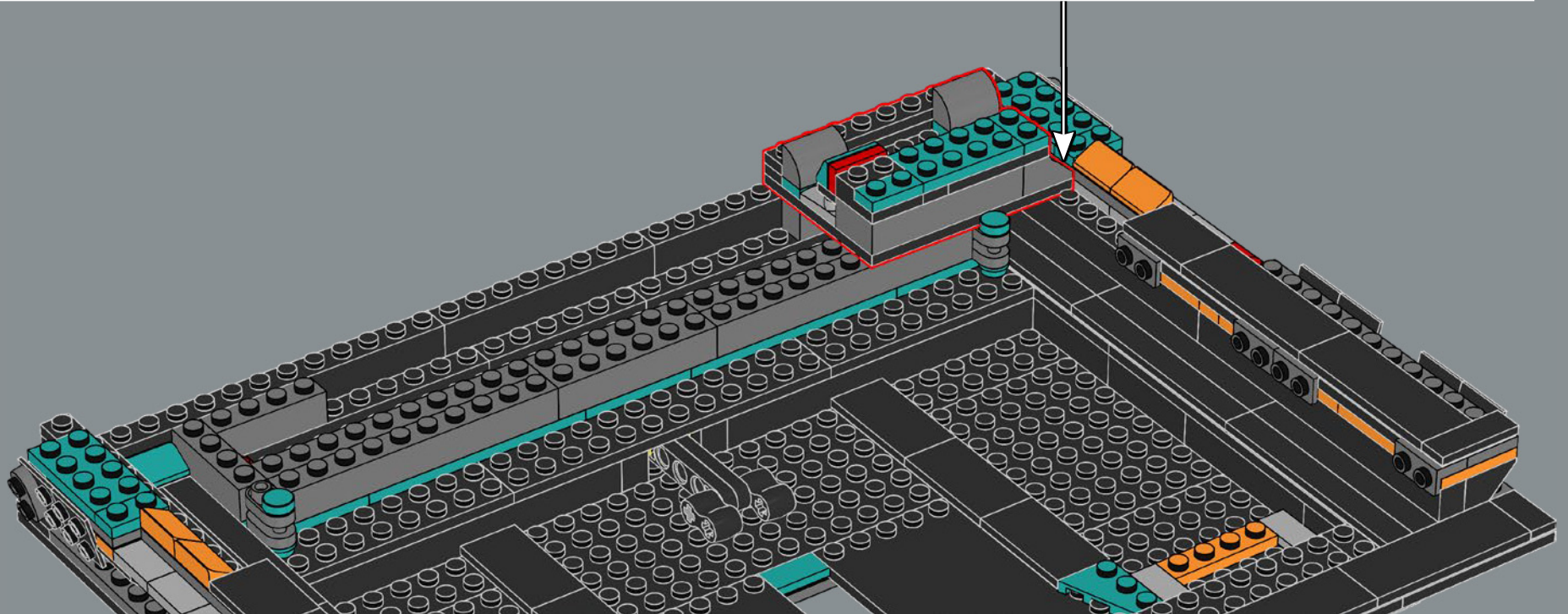

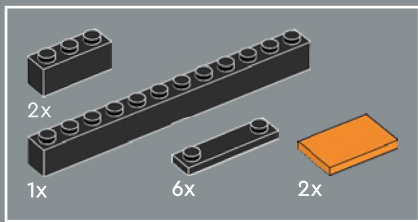

53

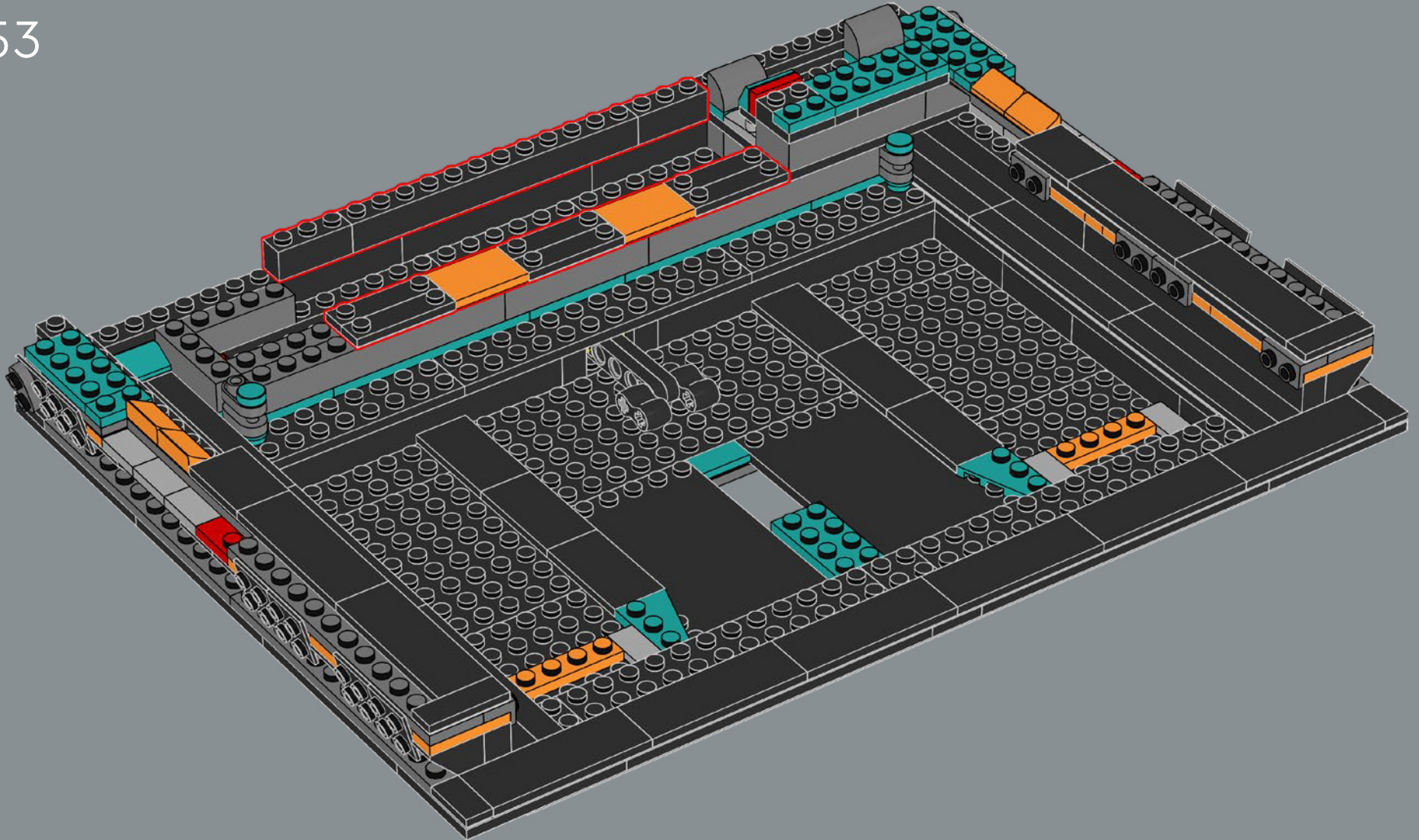

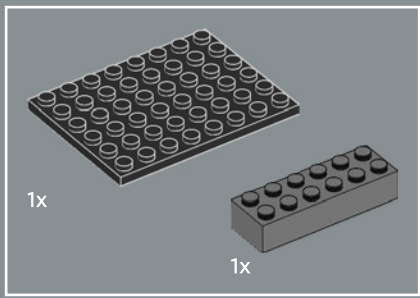

54

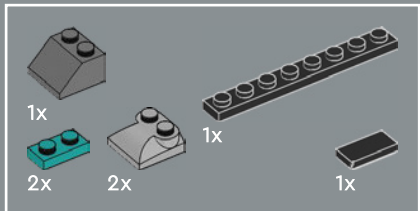
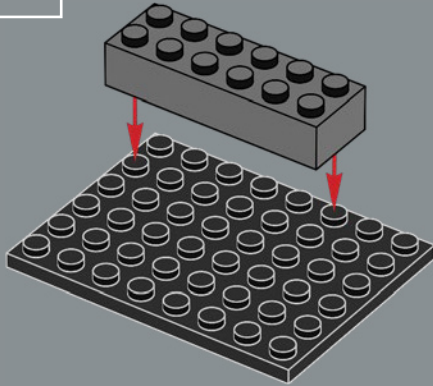

55

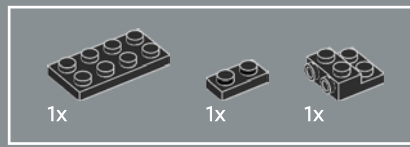
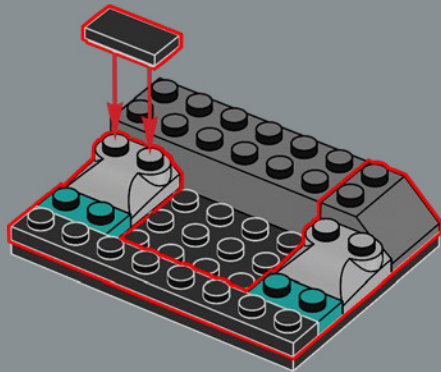

56

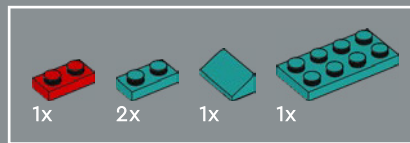
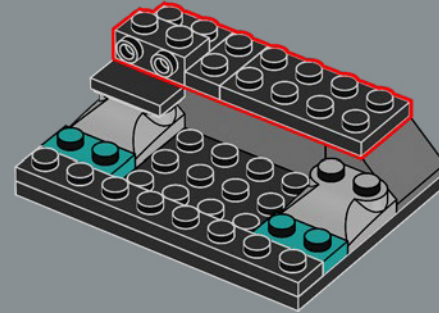

57

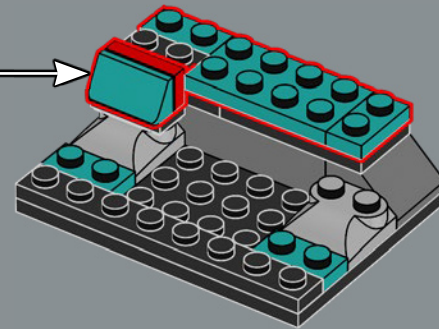
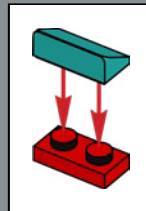

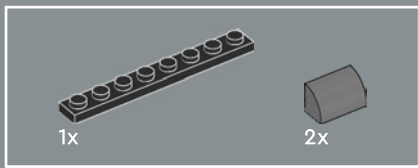

58

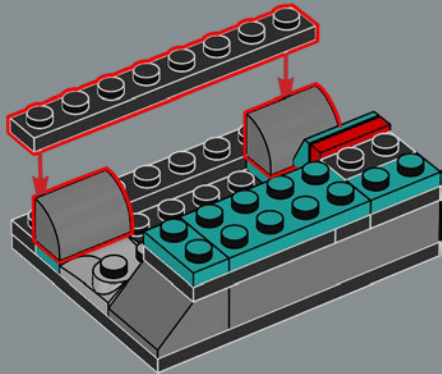

59

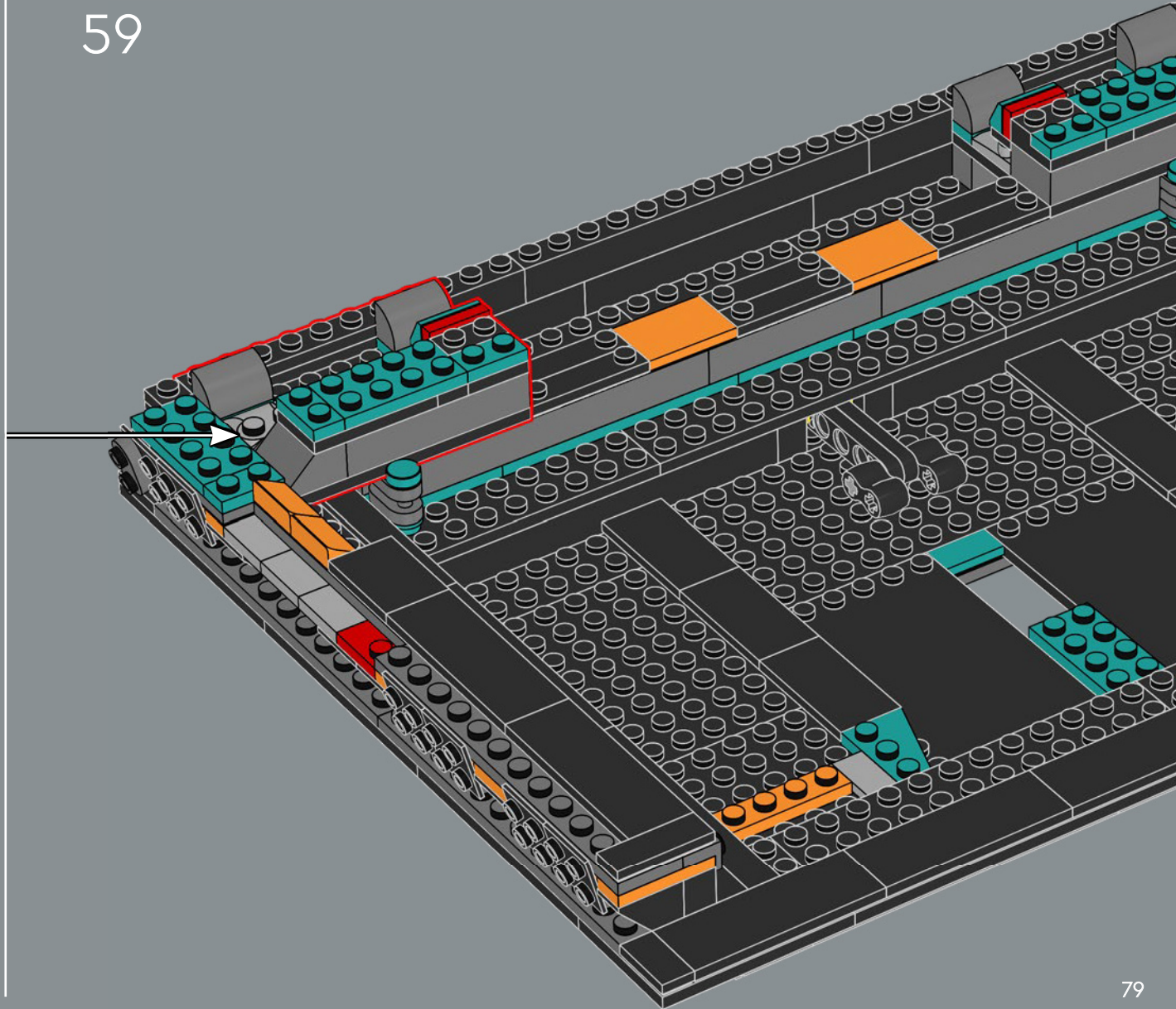

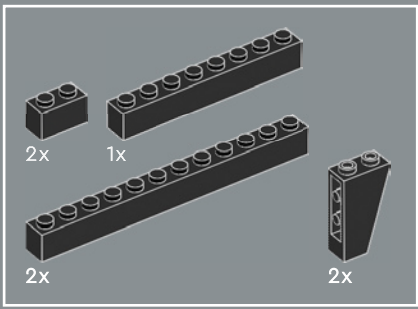

60

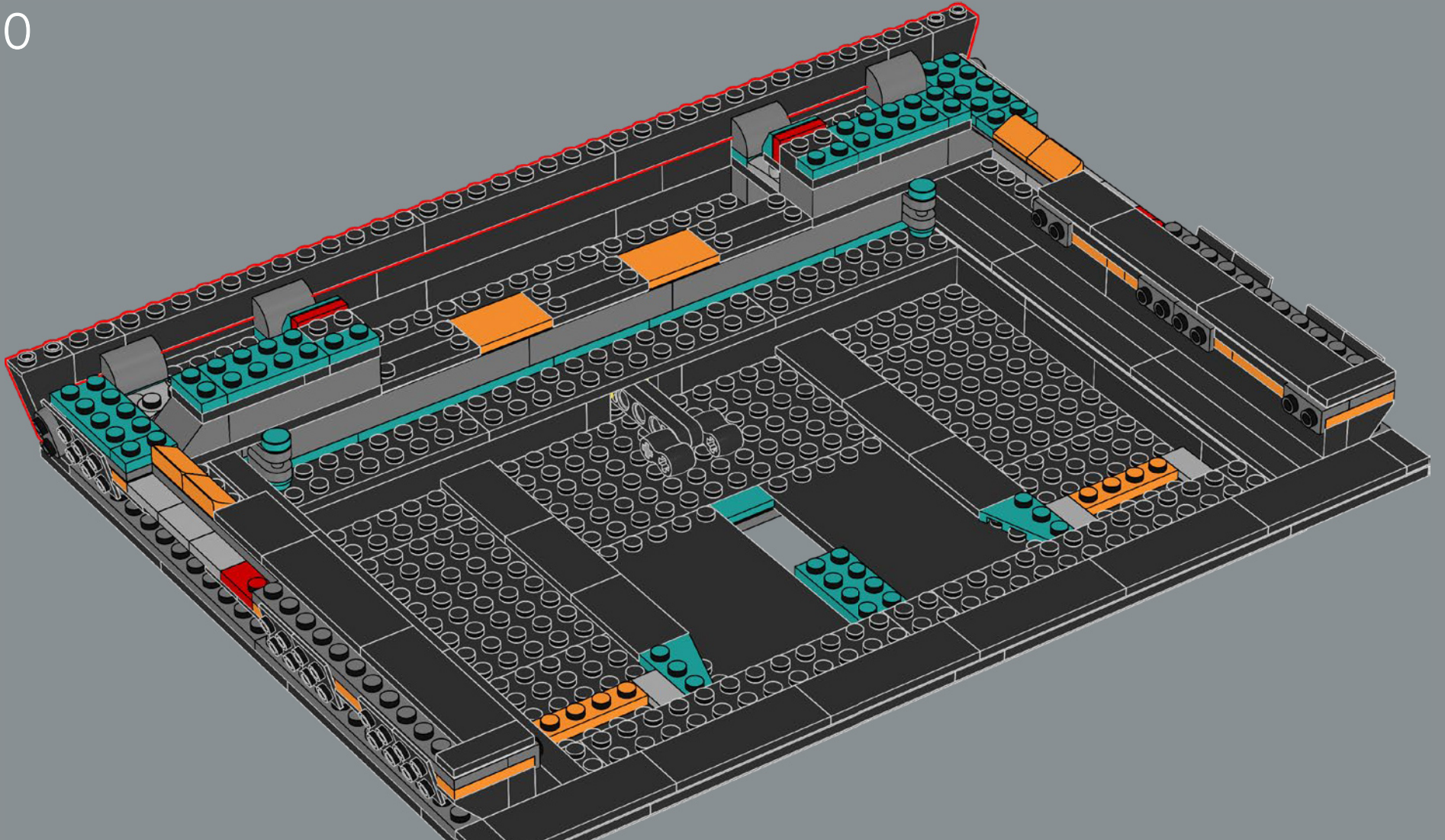

80

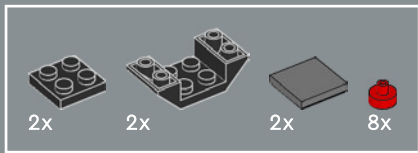

61

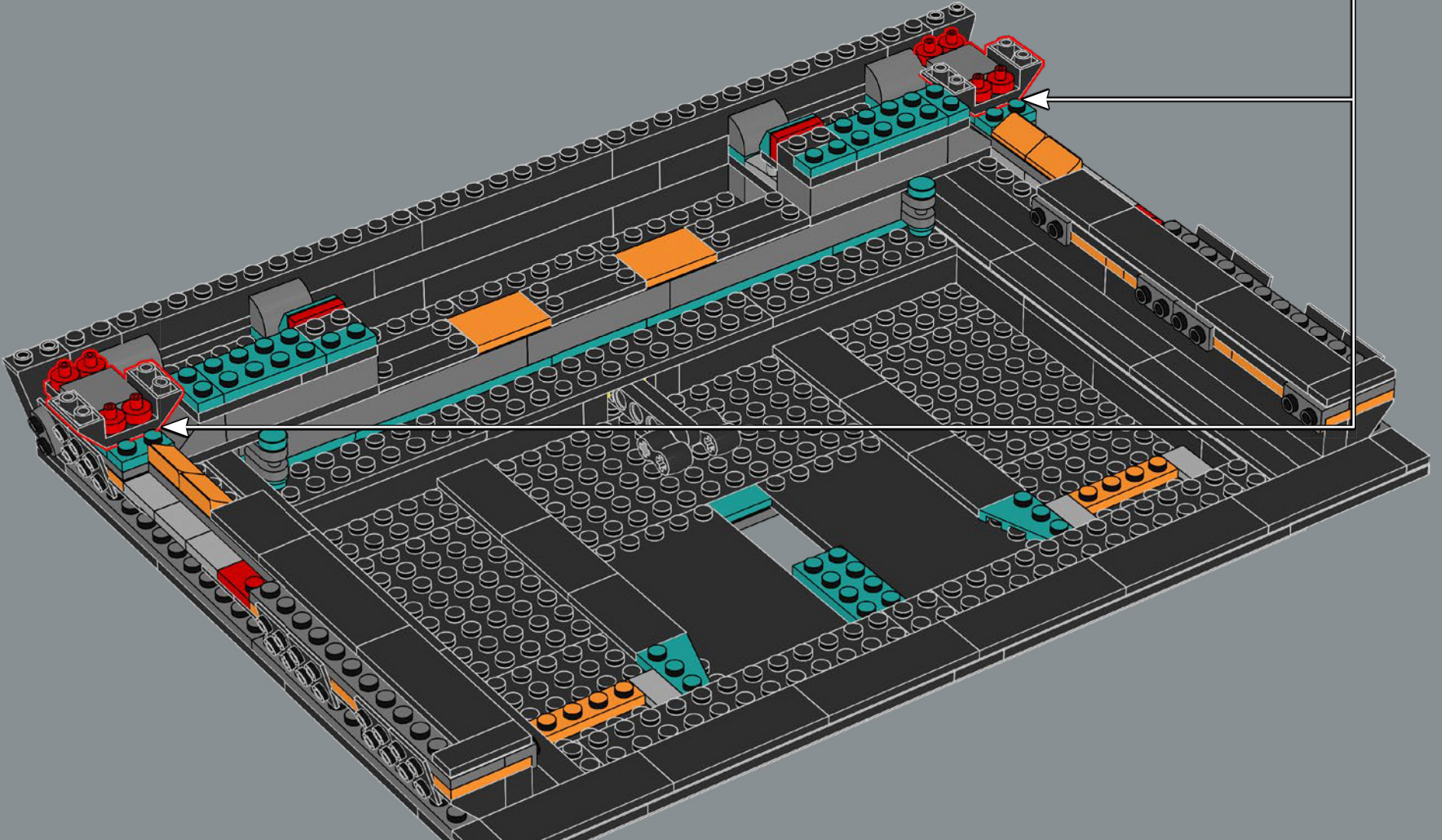
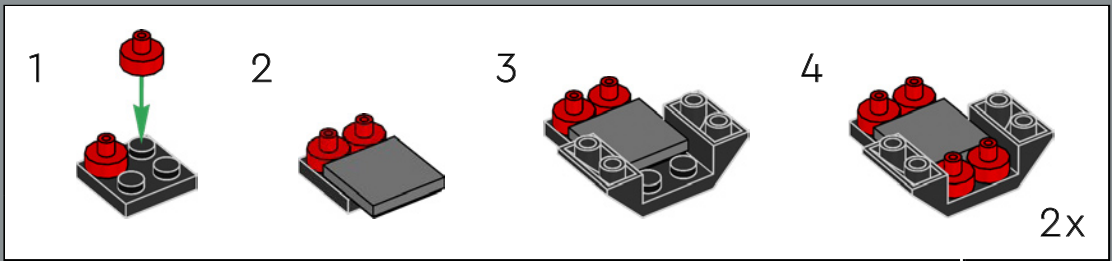

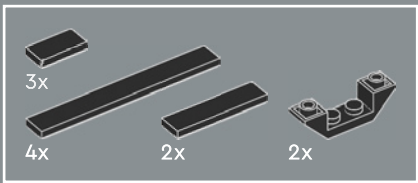

62

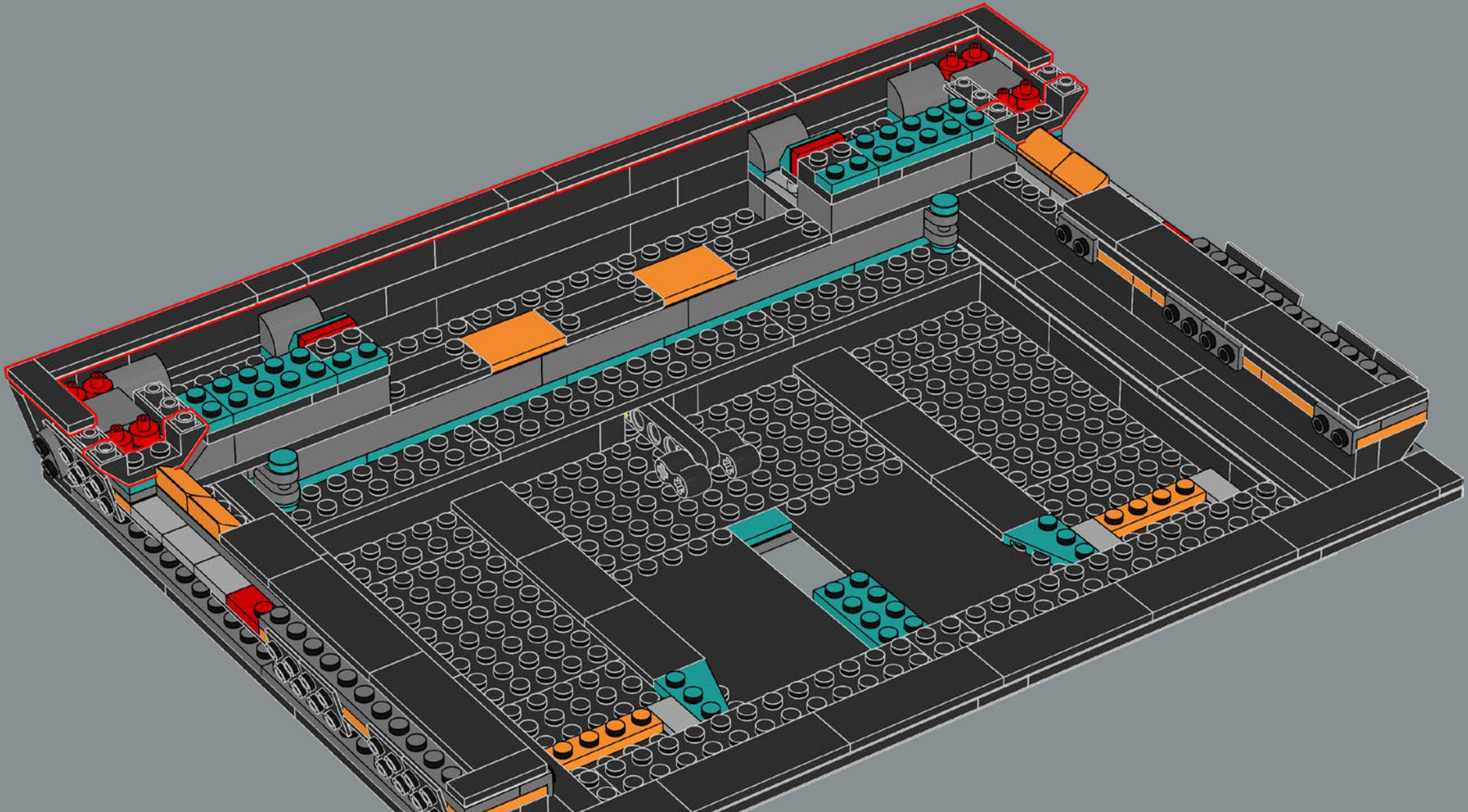

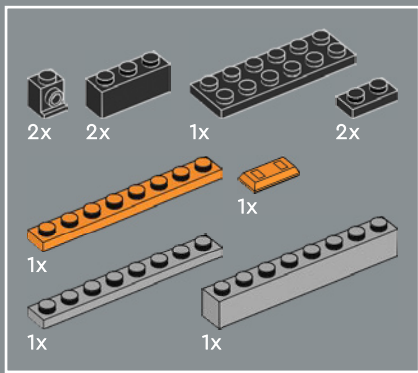

63

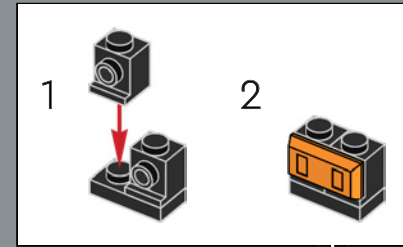
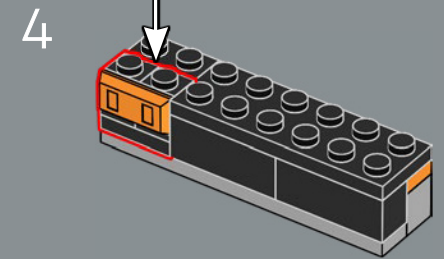
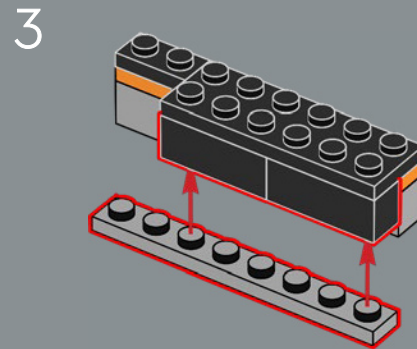
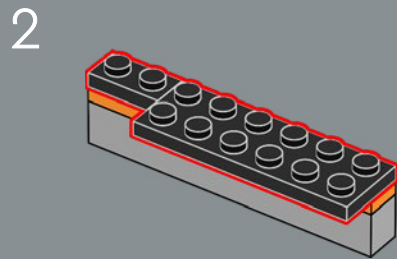
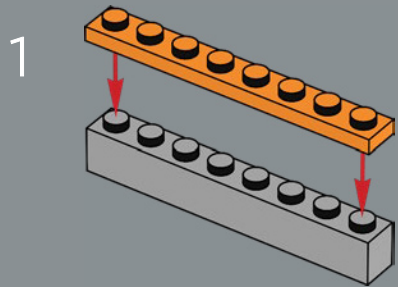

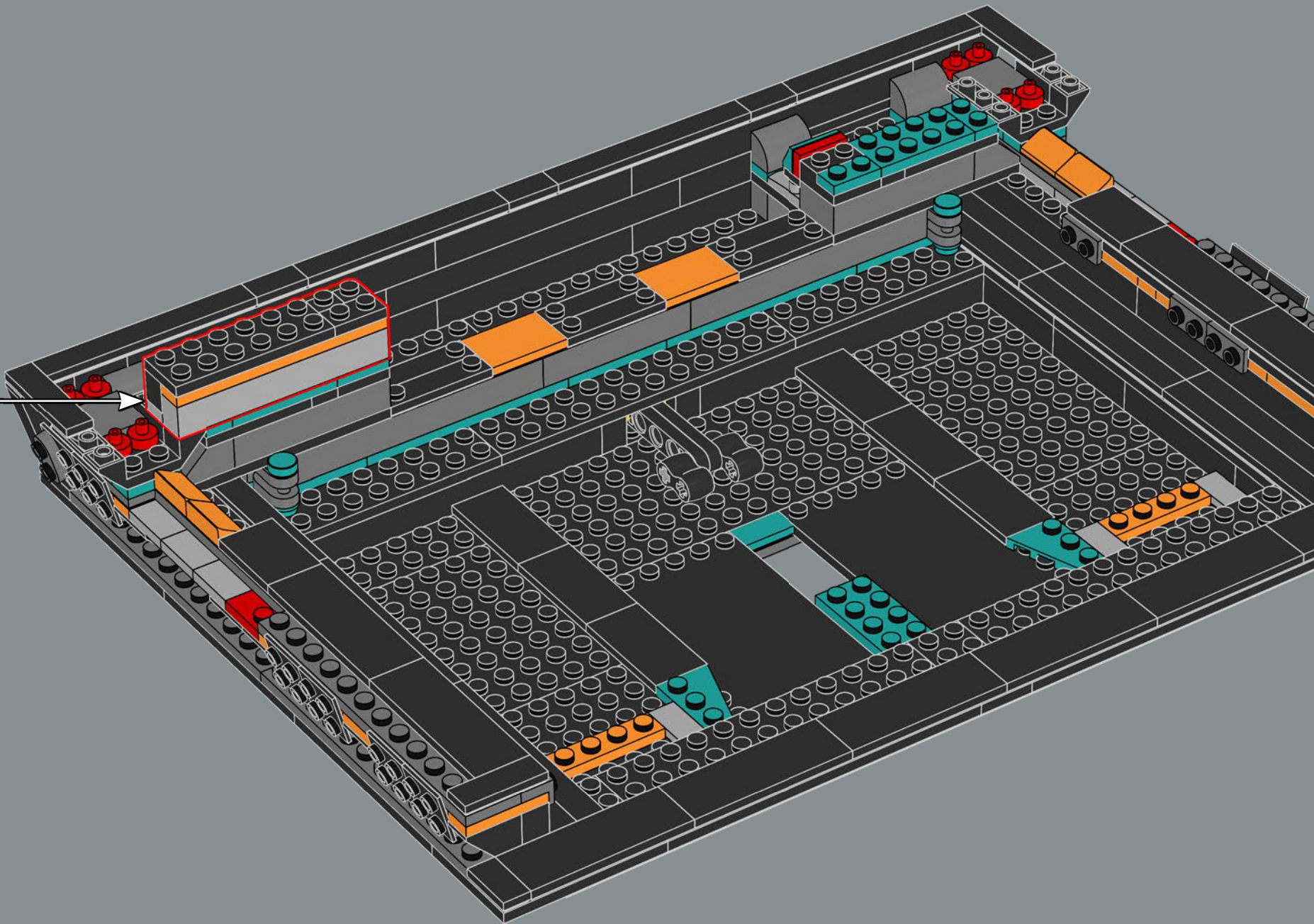

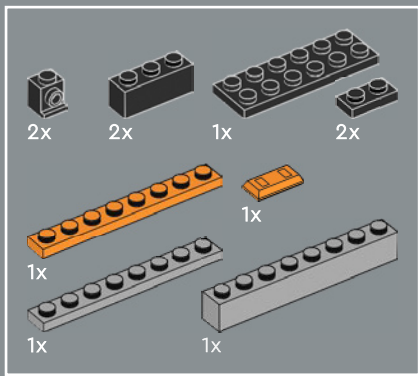

64

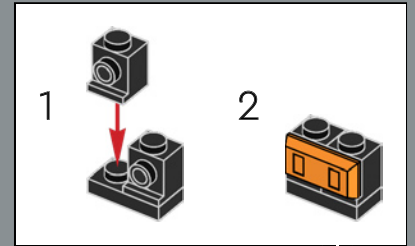
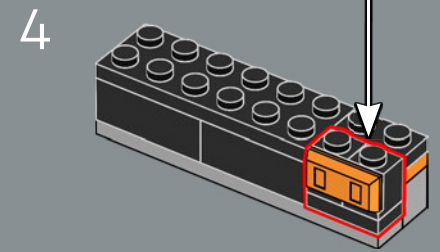
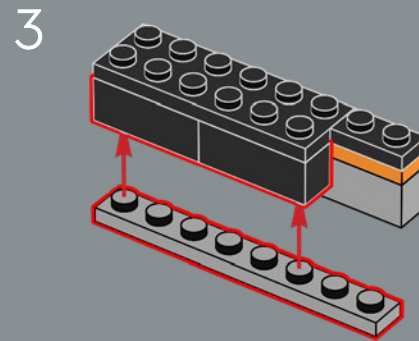
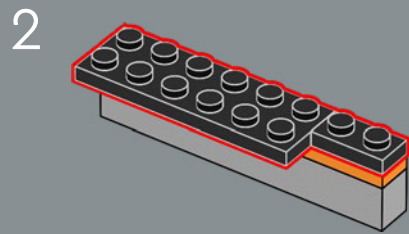
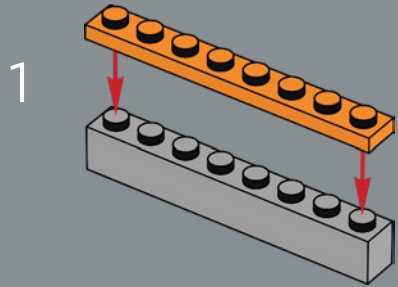

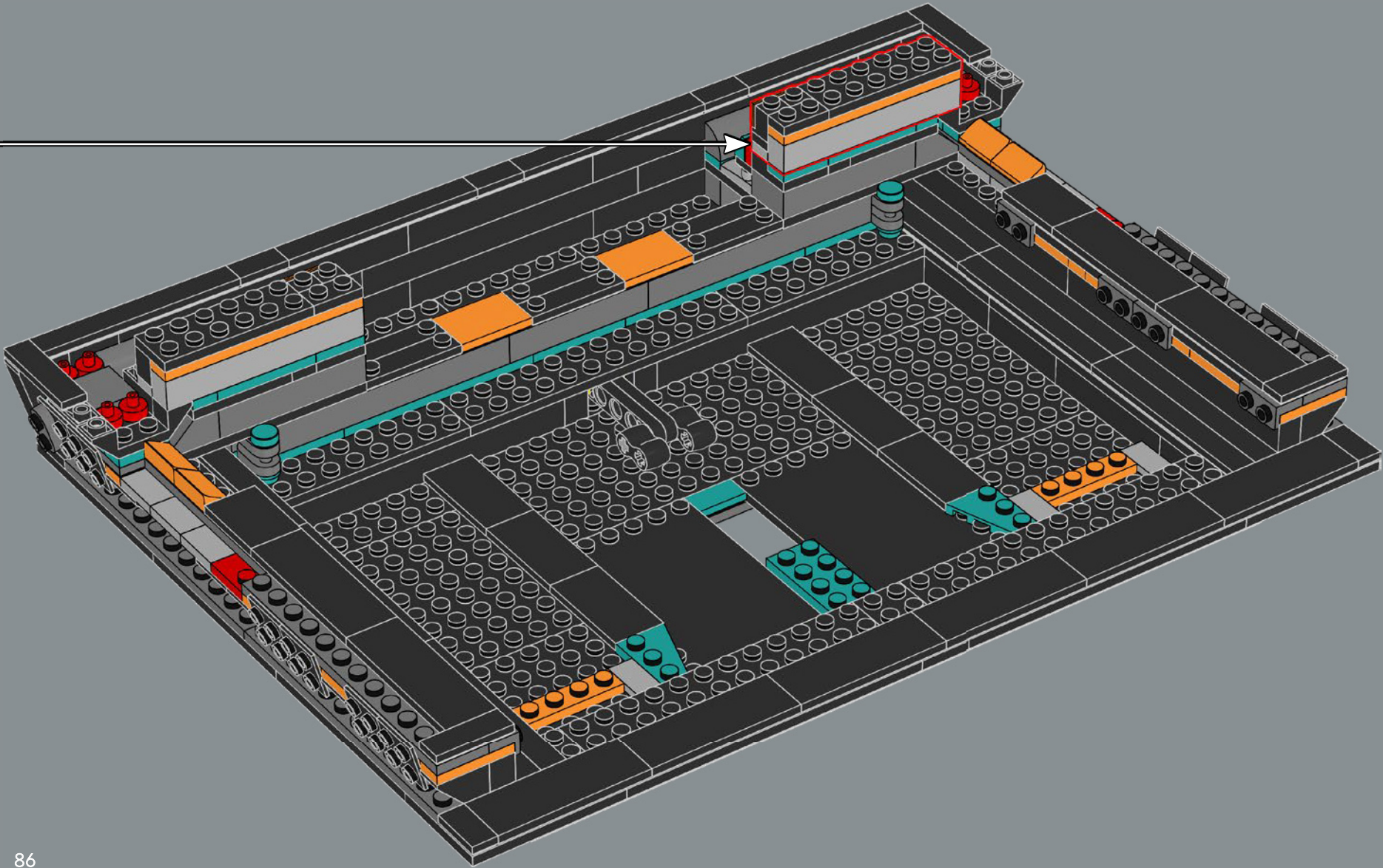

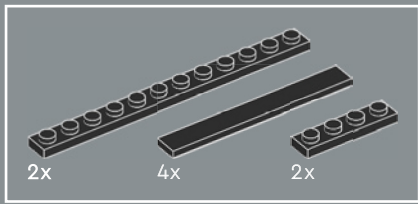

65

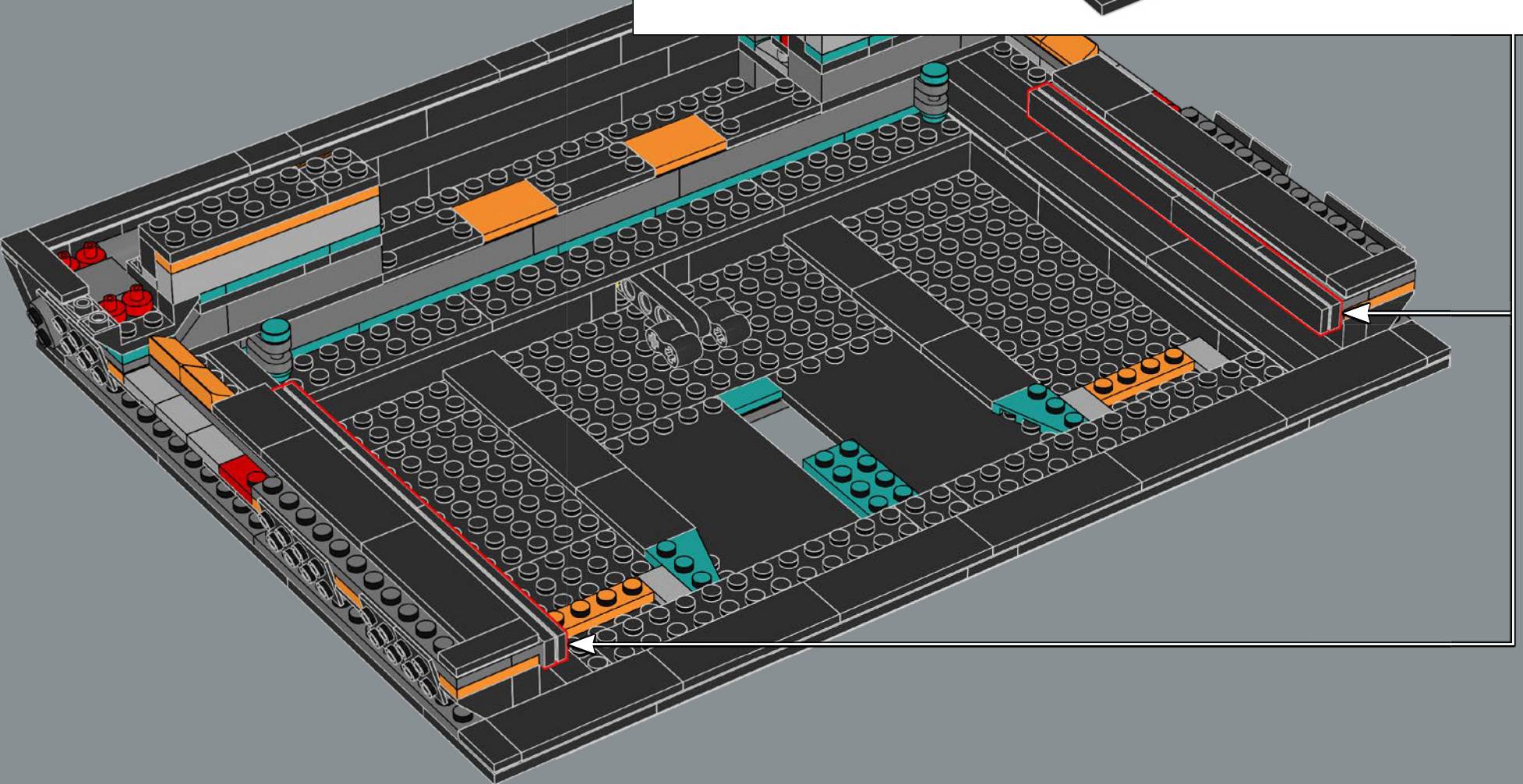
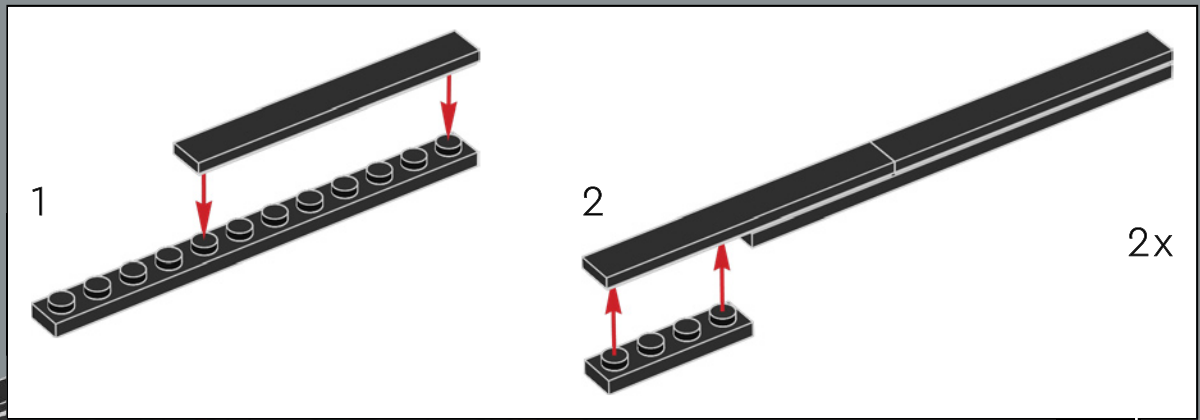

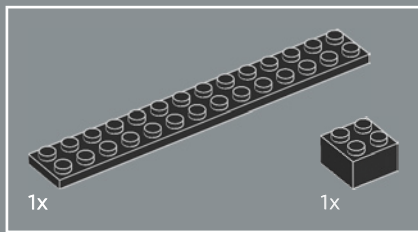

66

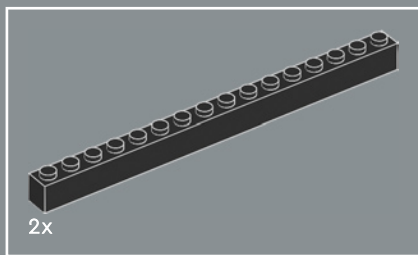
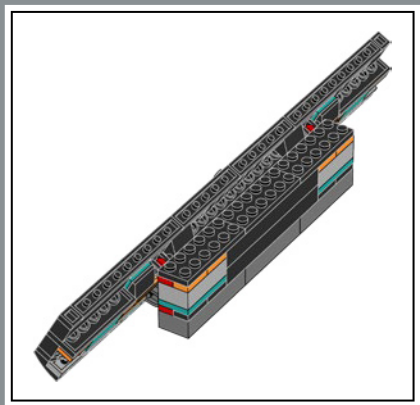
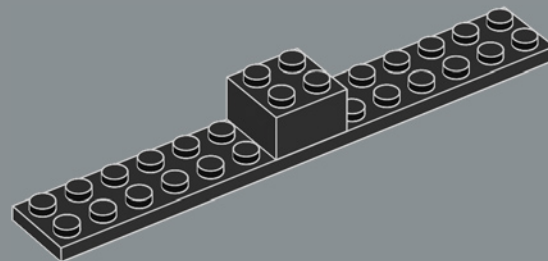

67

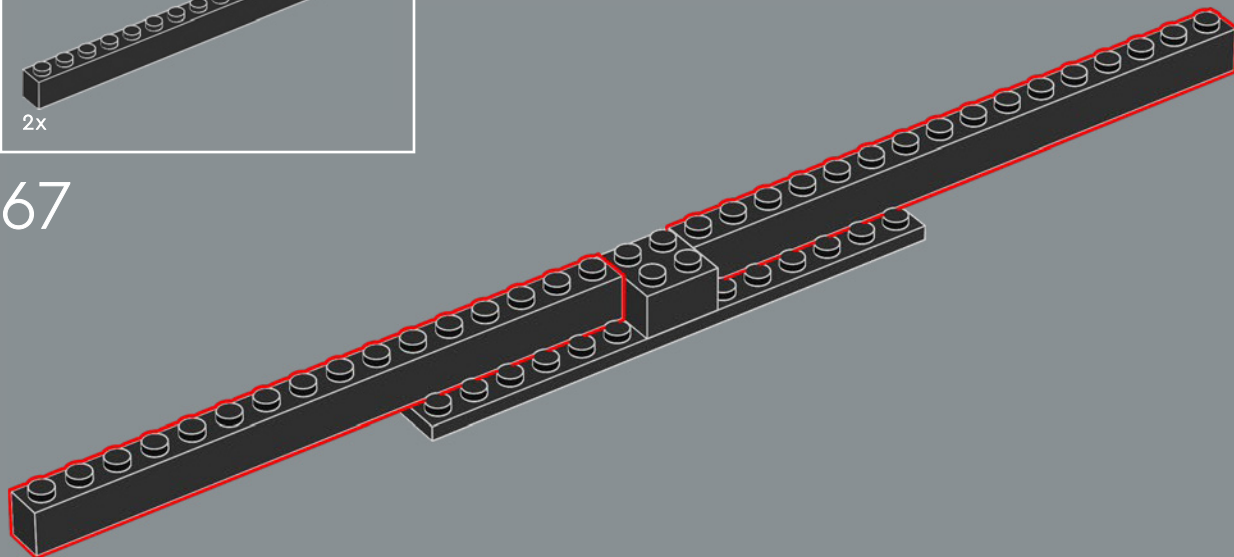

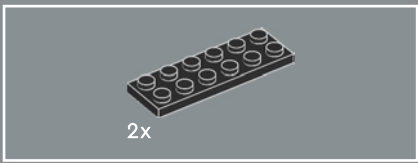

68

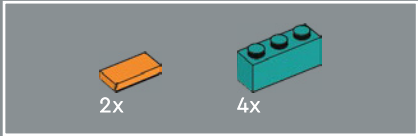
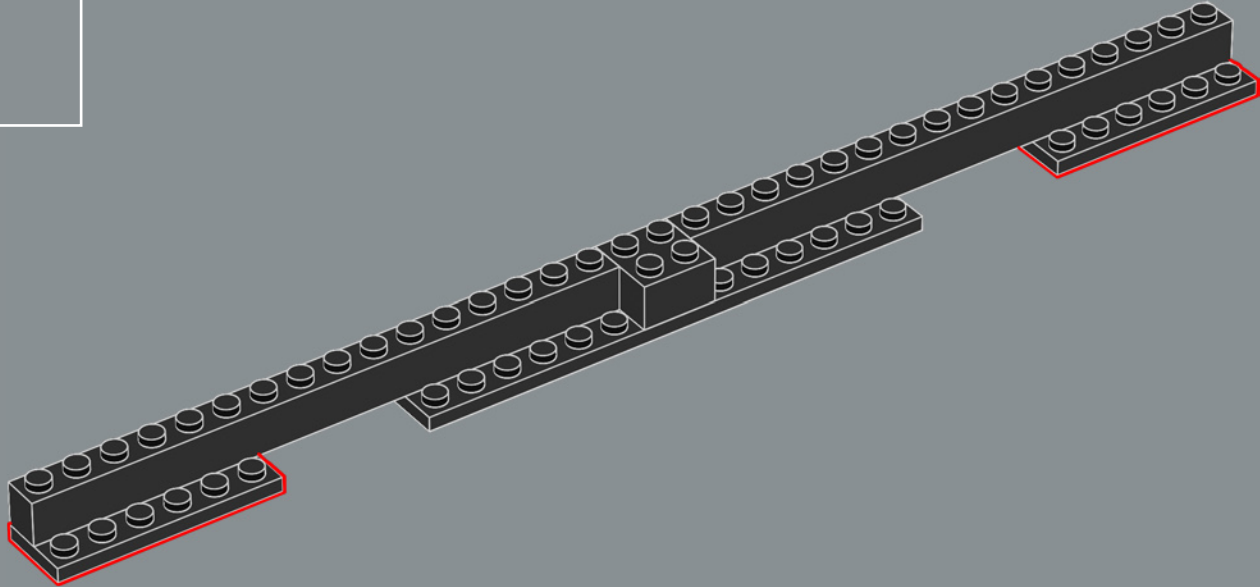

69

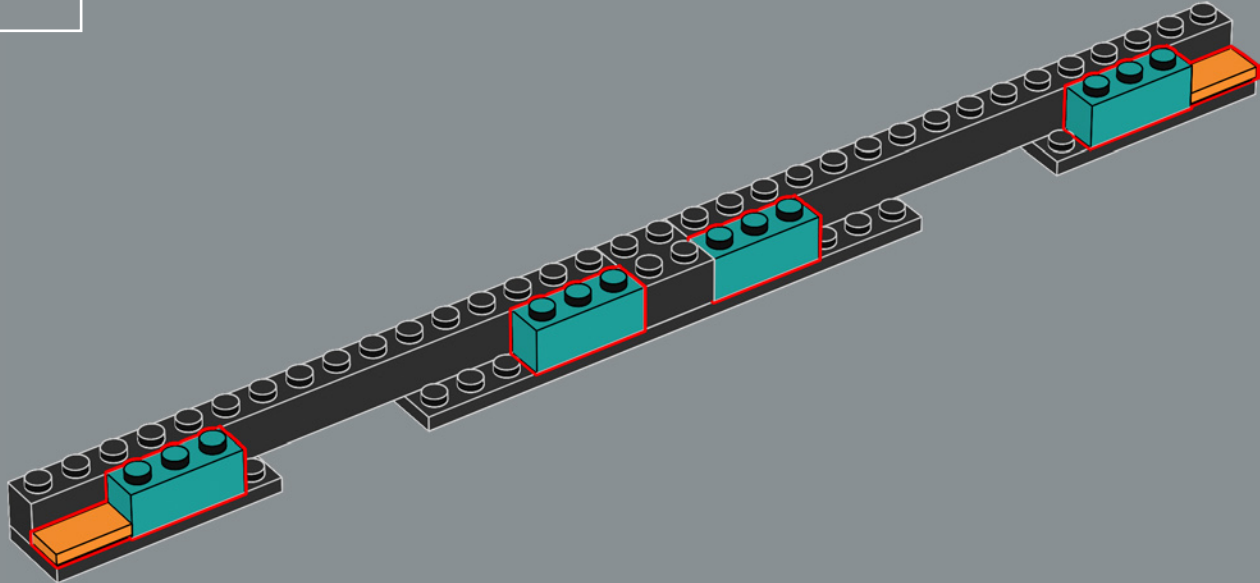

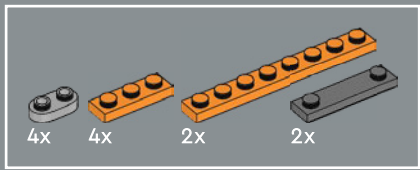

70

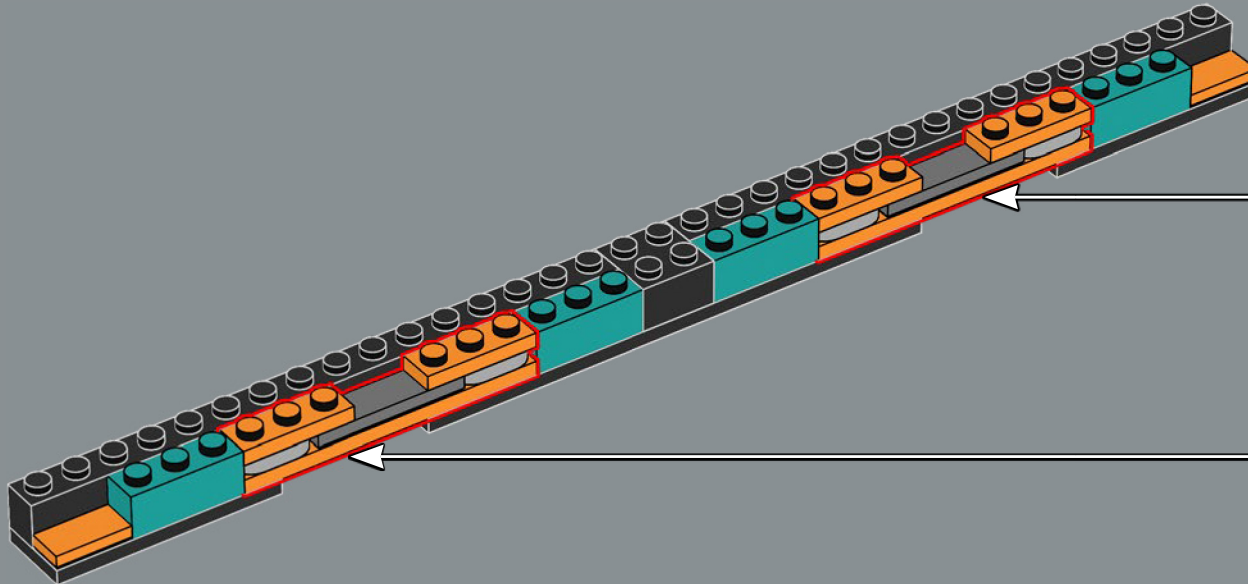
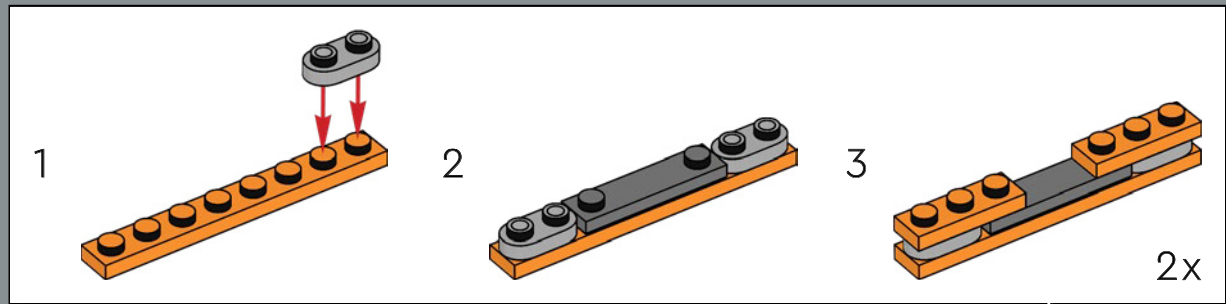

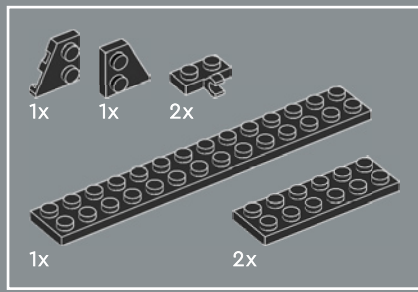

71

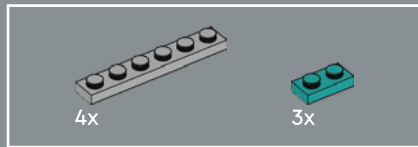
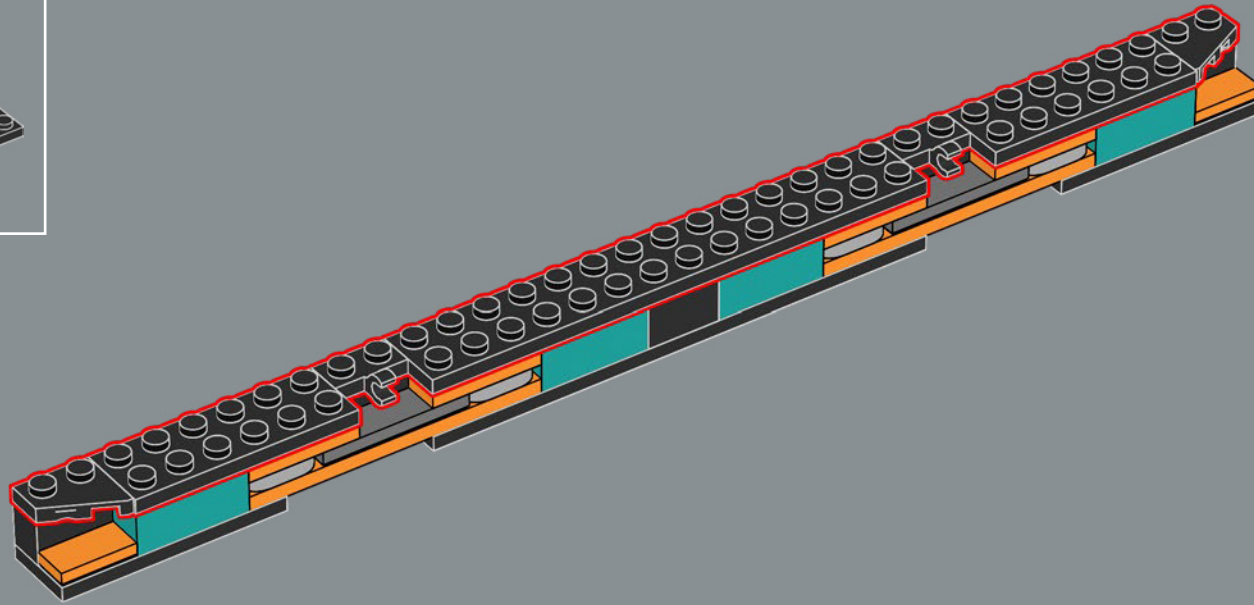

72

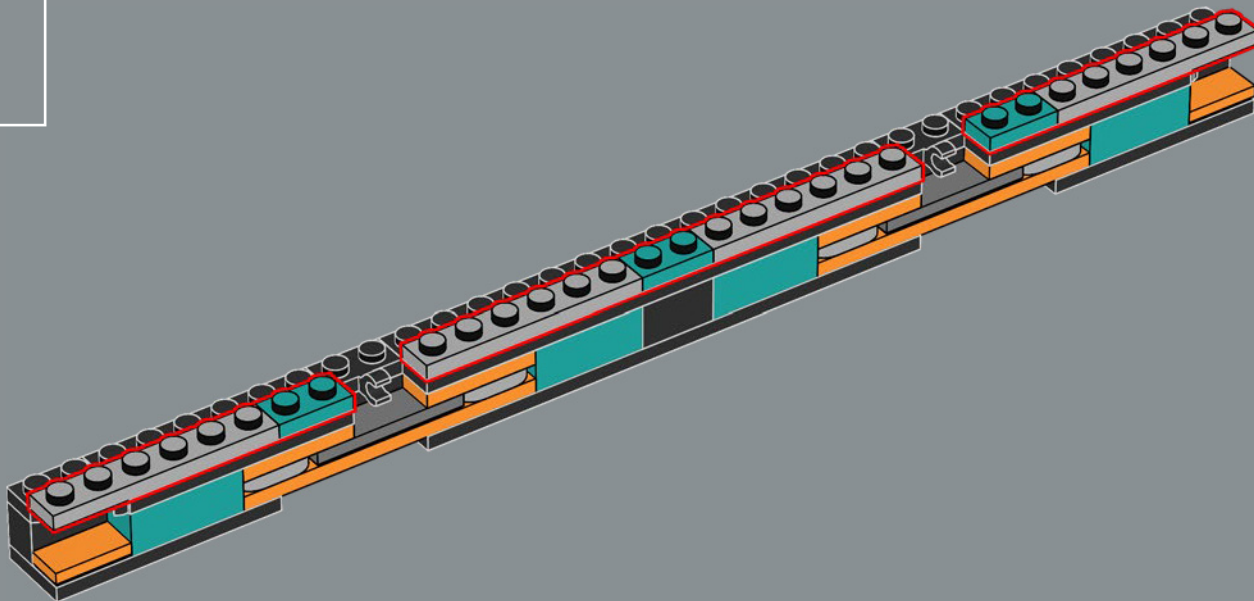

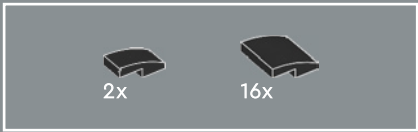

73

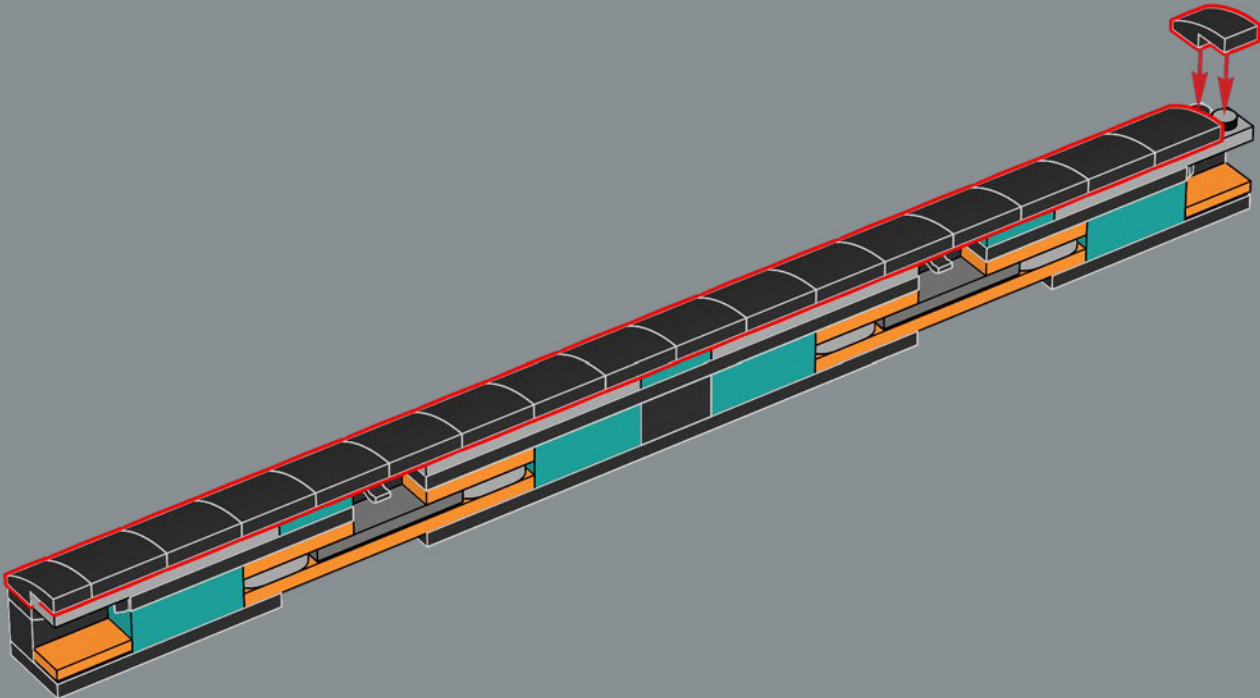

74

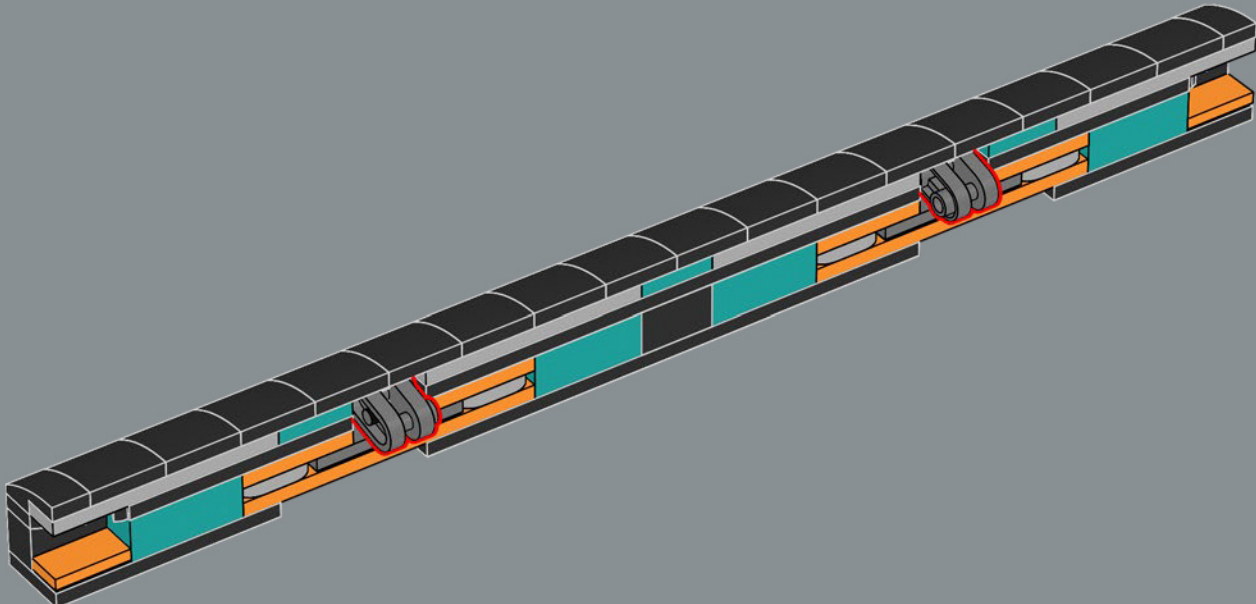

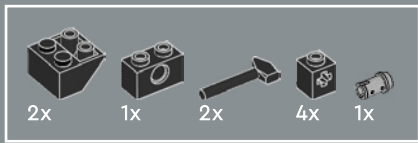

75

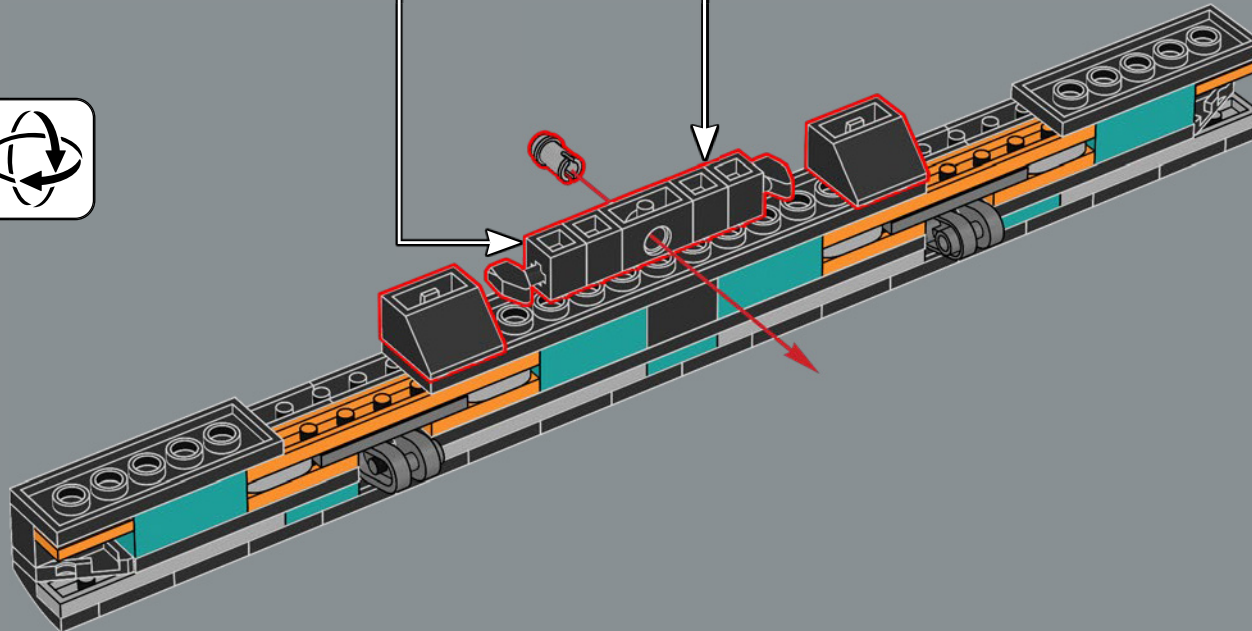
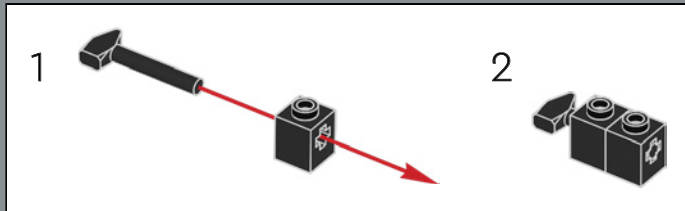
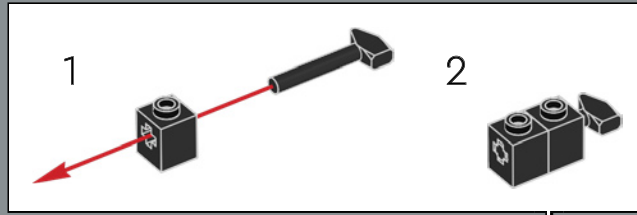

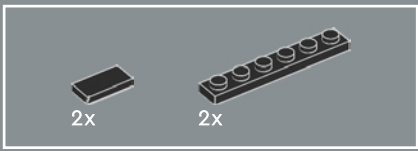

76

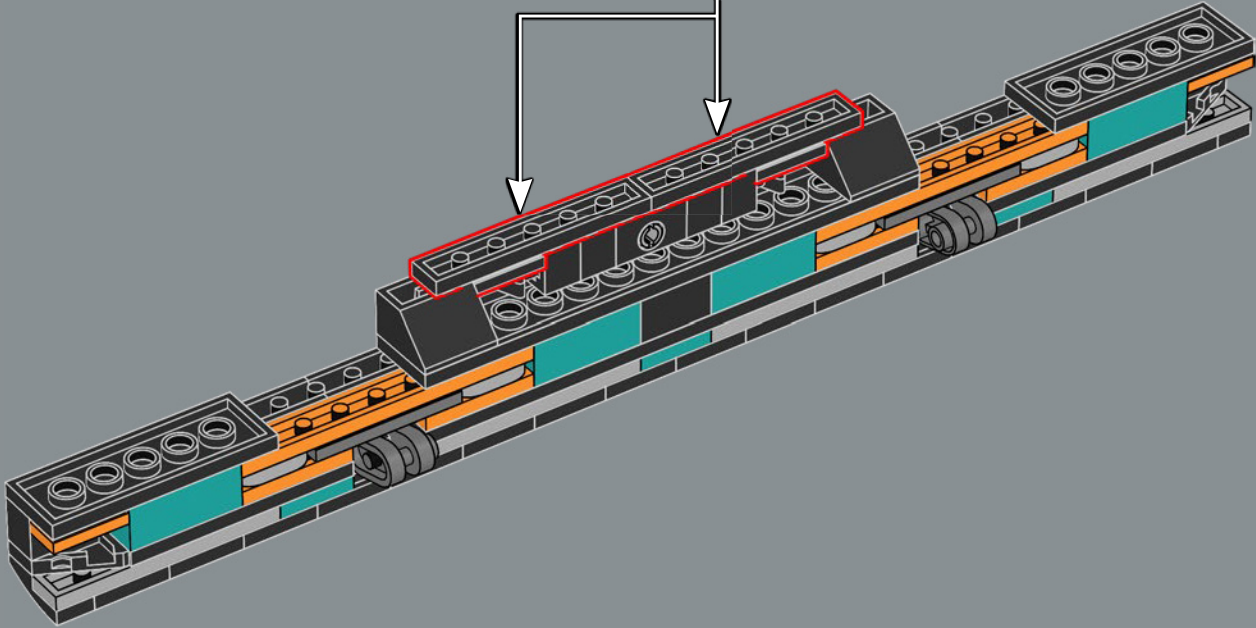
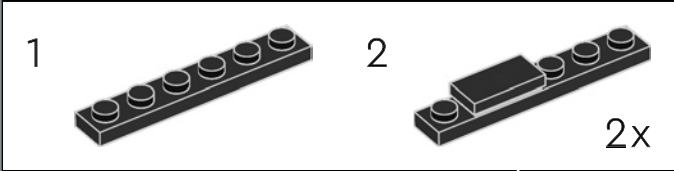

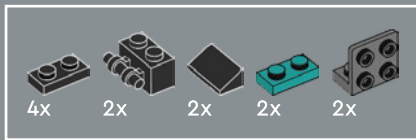

77

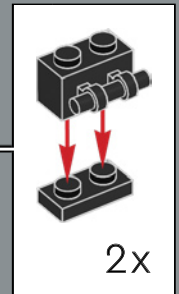
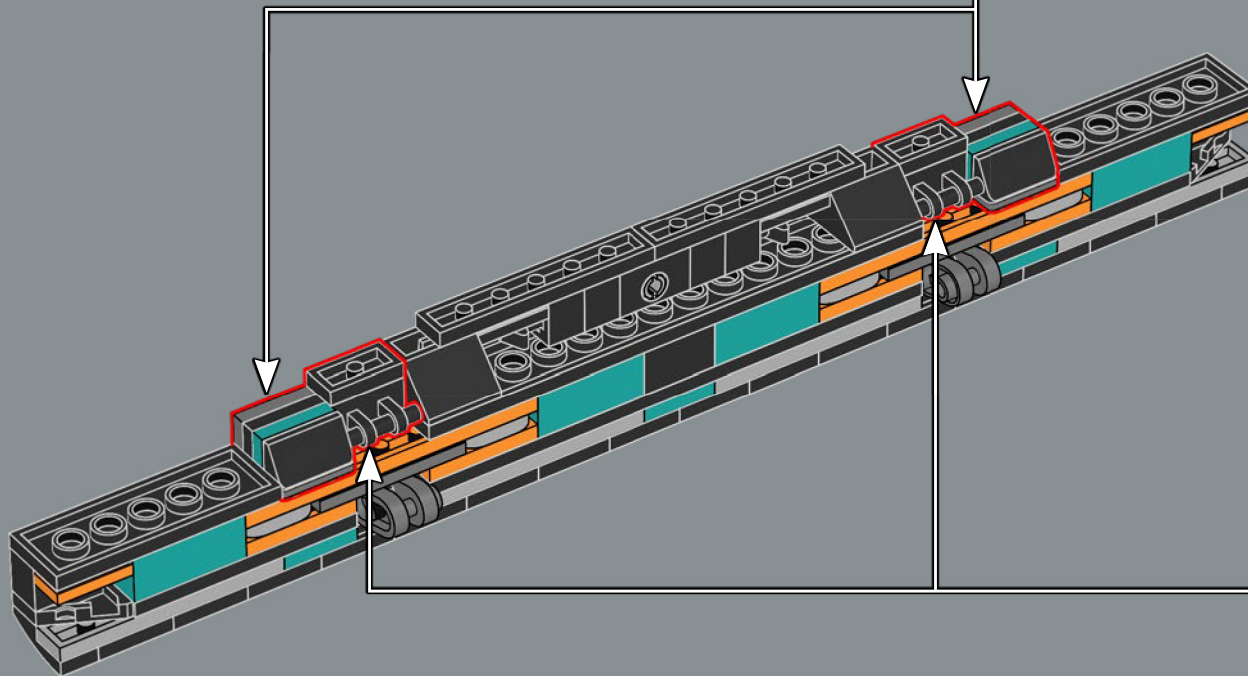
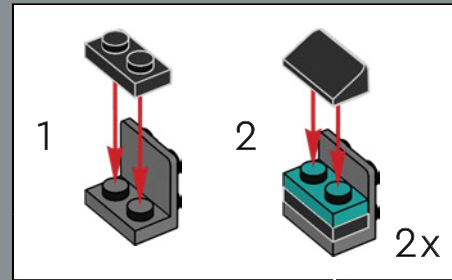

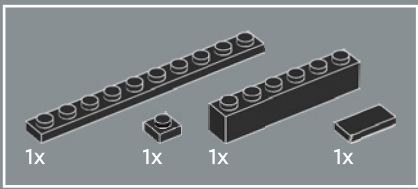

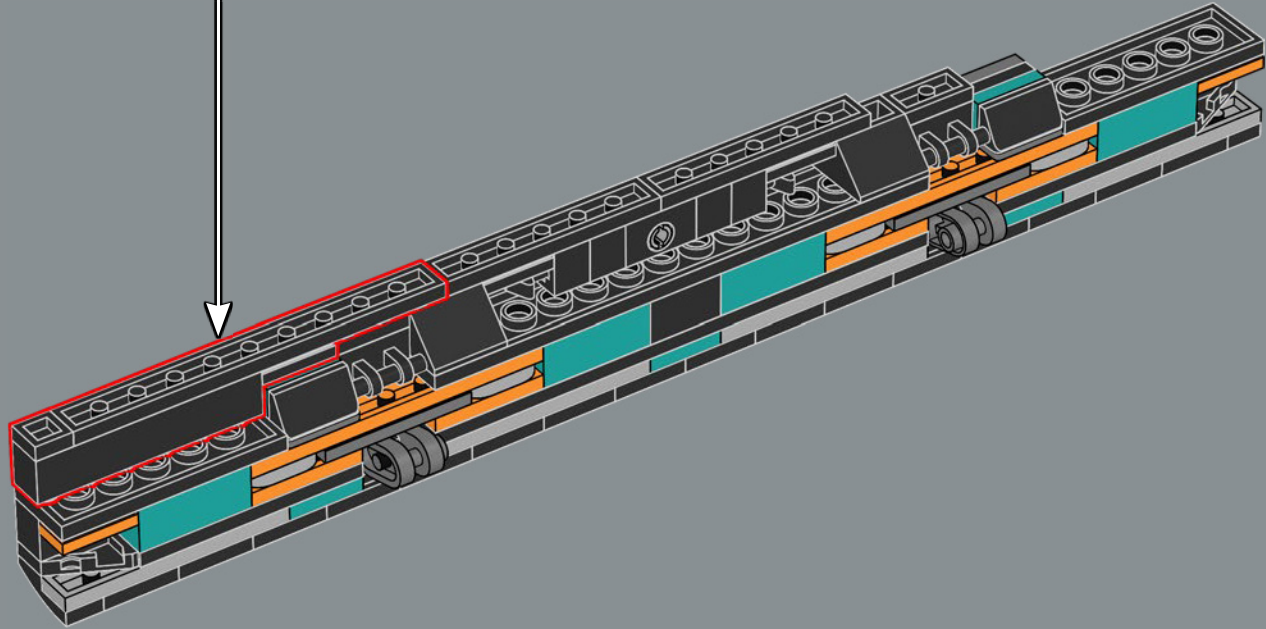
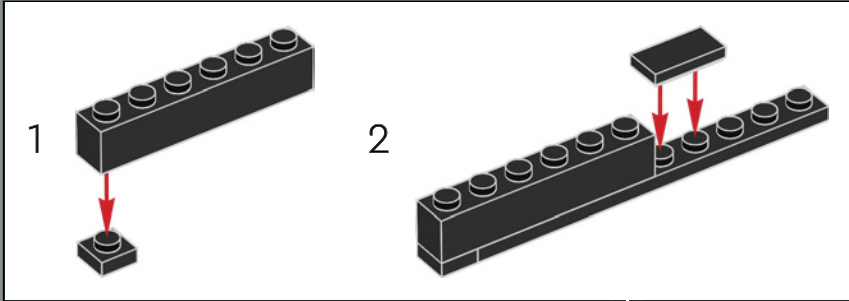

78

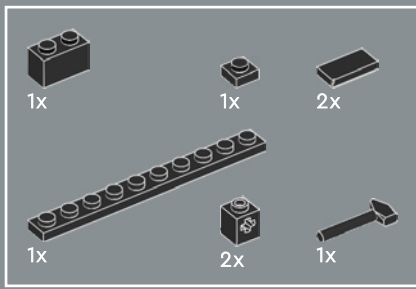

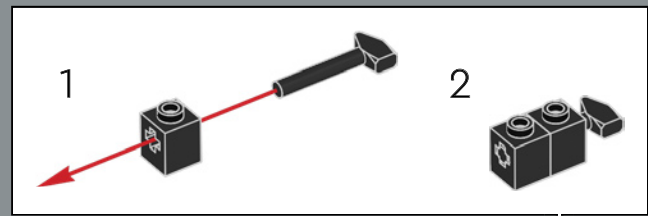
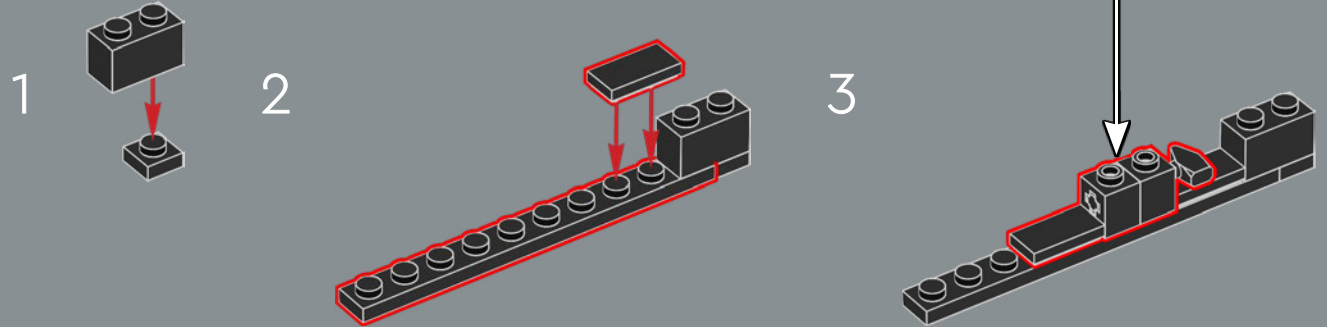

79



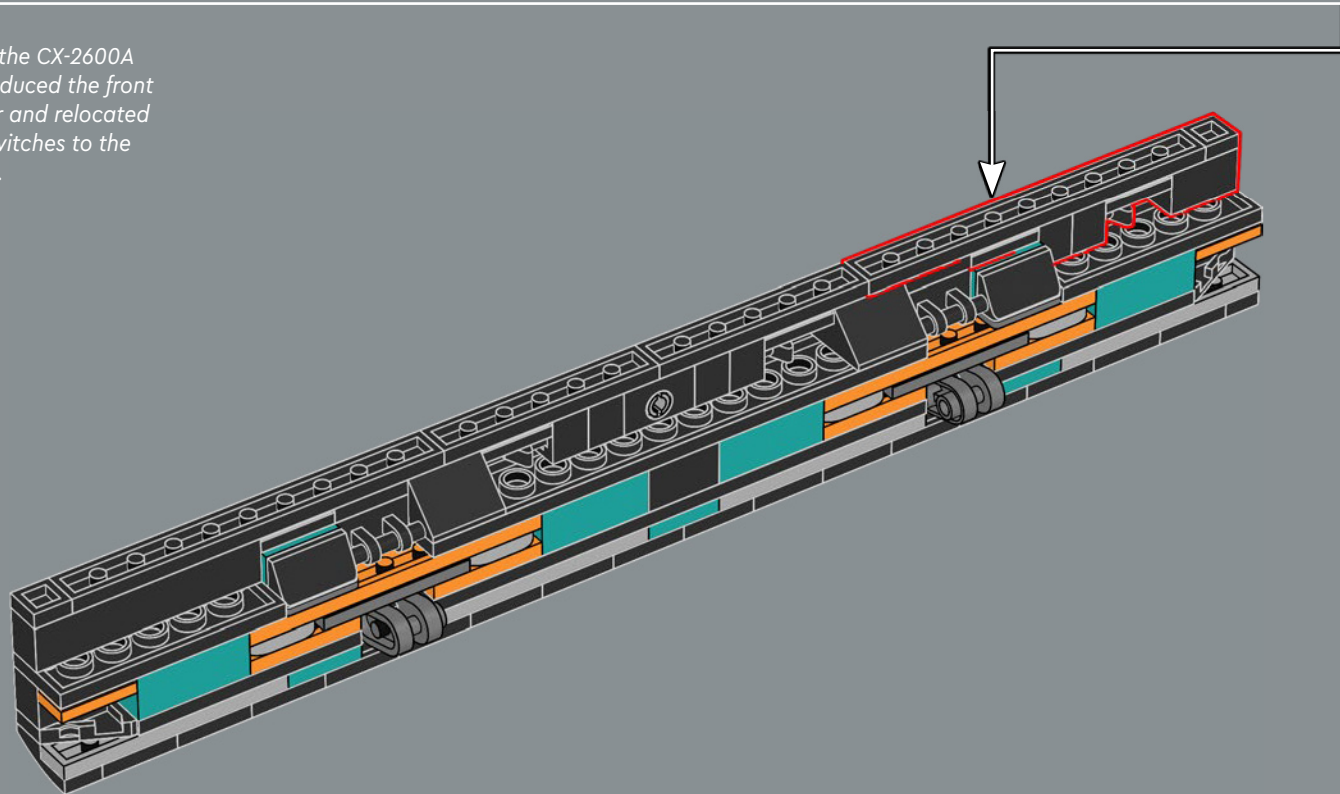

 Introduced in 1980, the CX-2600A model of the VCS reduced the front switch count to four and relocated the two difficulty switches to the back of the console.

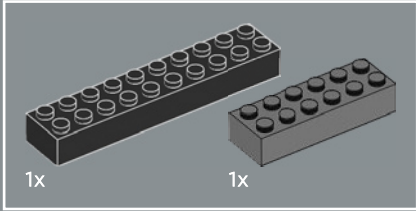
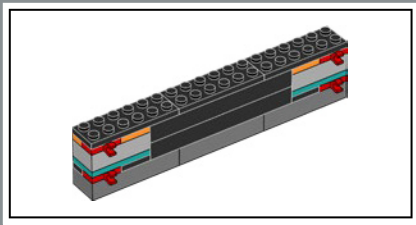

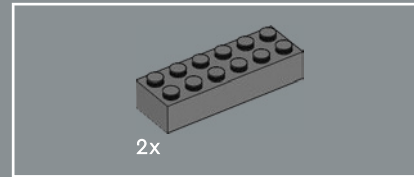
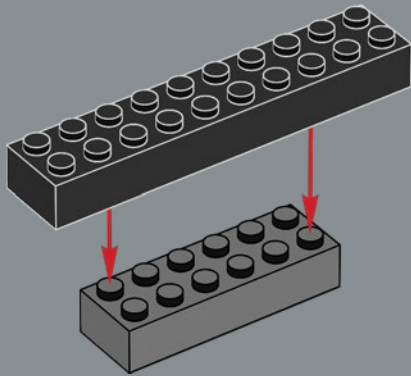

80



81

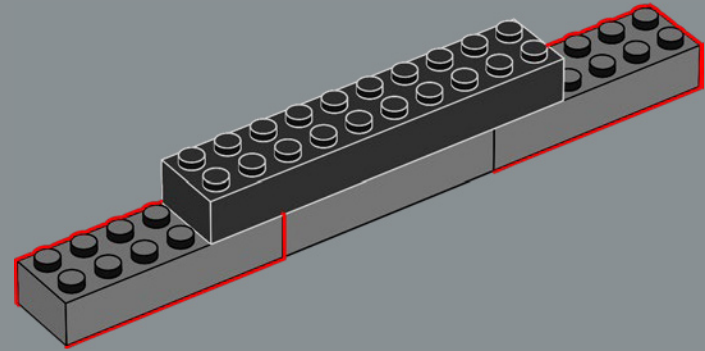

82

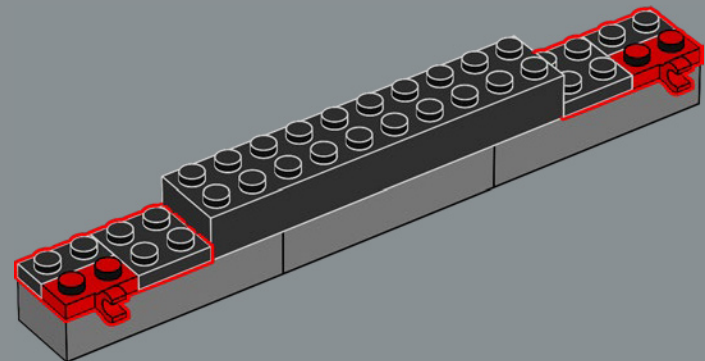

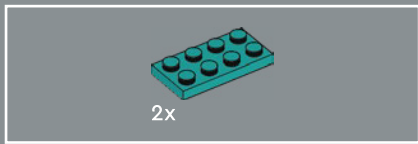

83

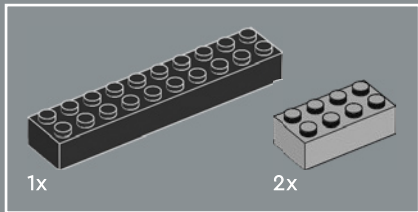
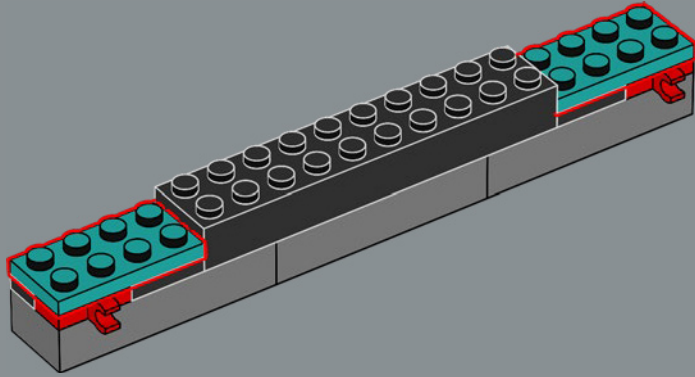

84

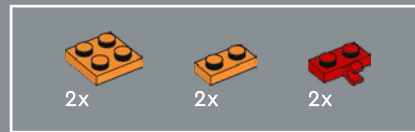
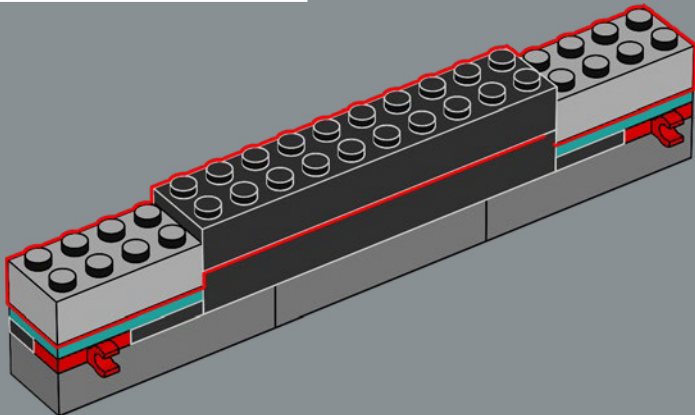

85

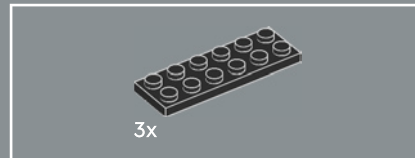
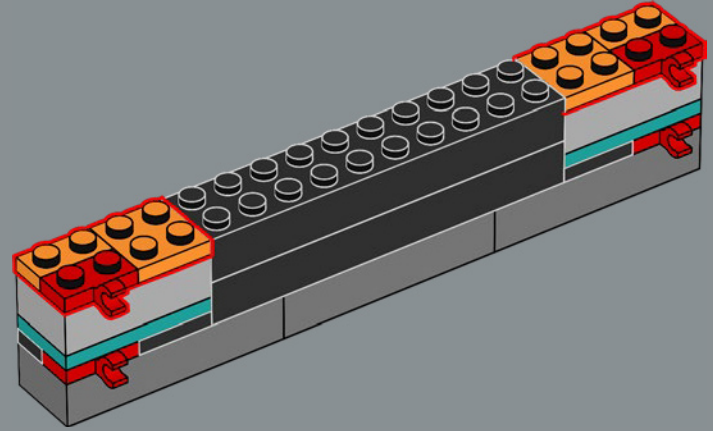

86

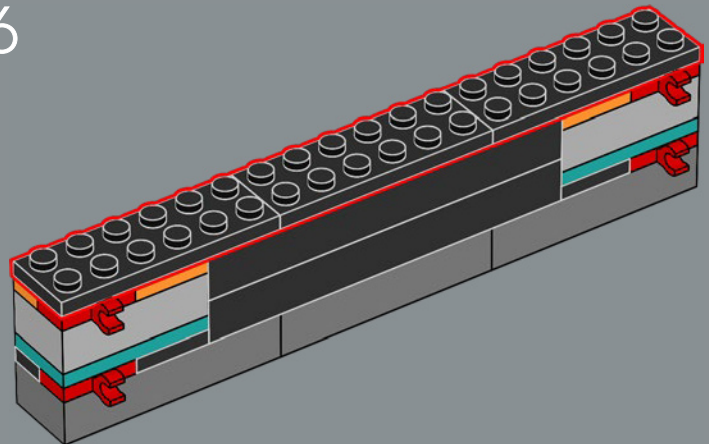

87

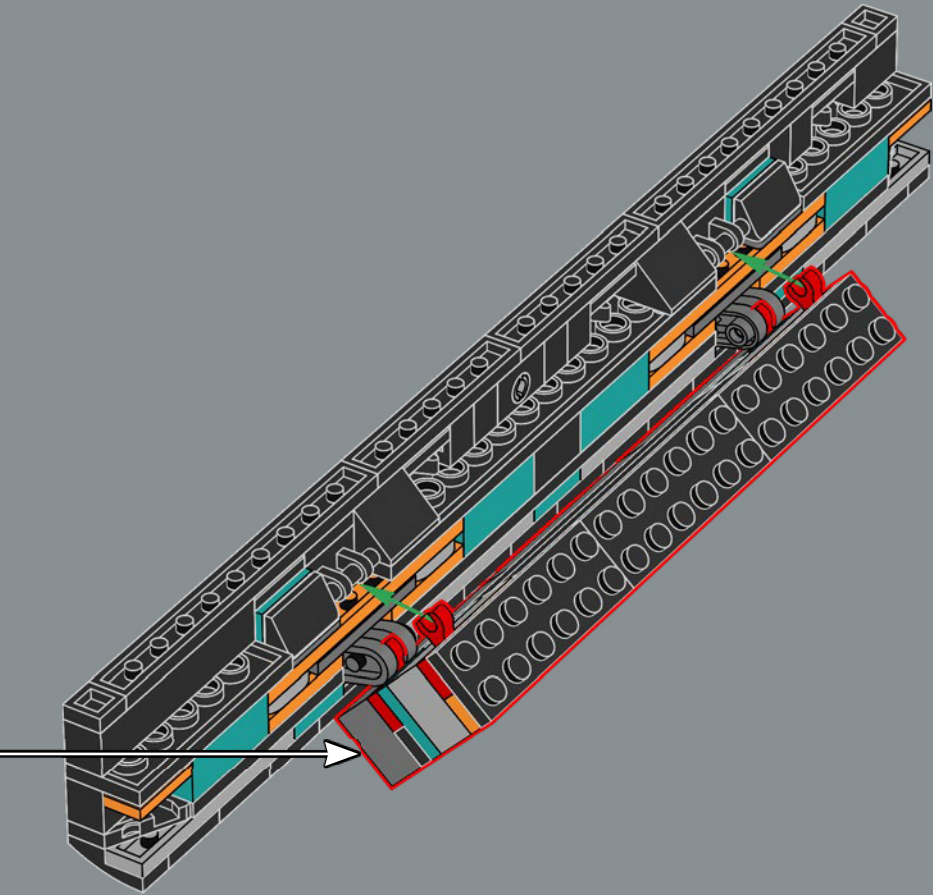

88

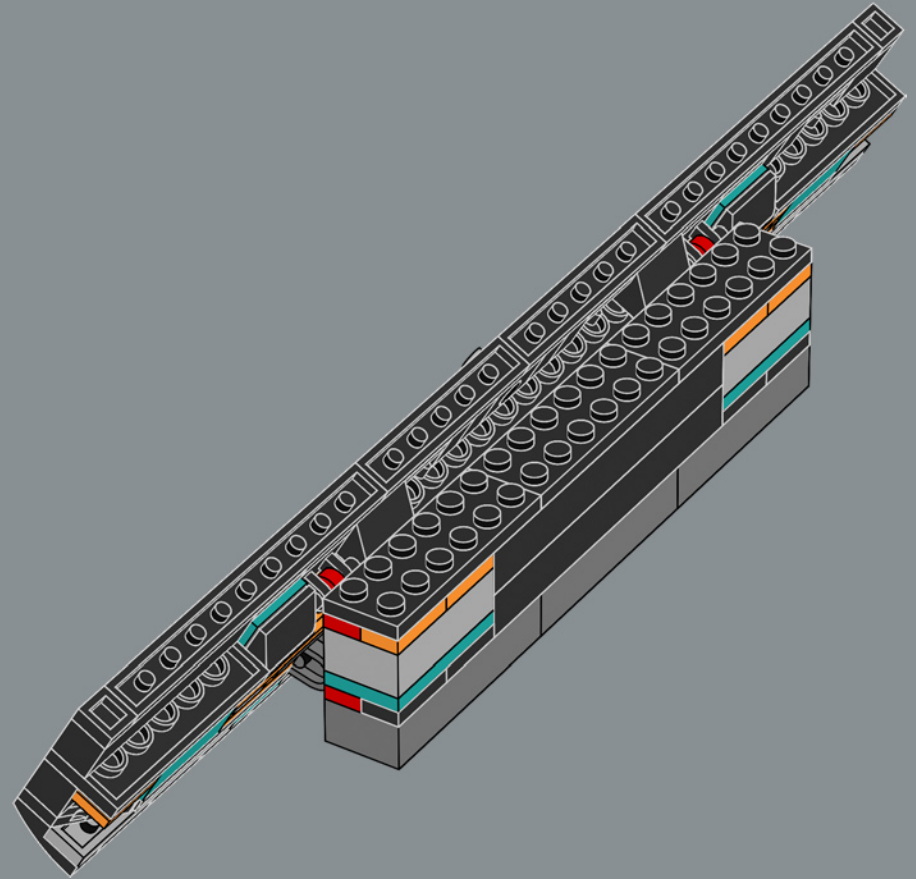

89

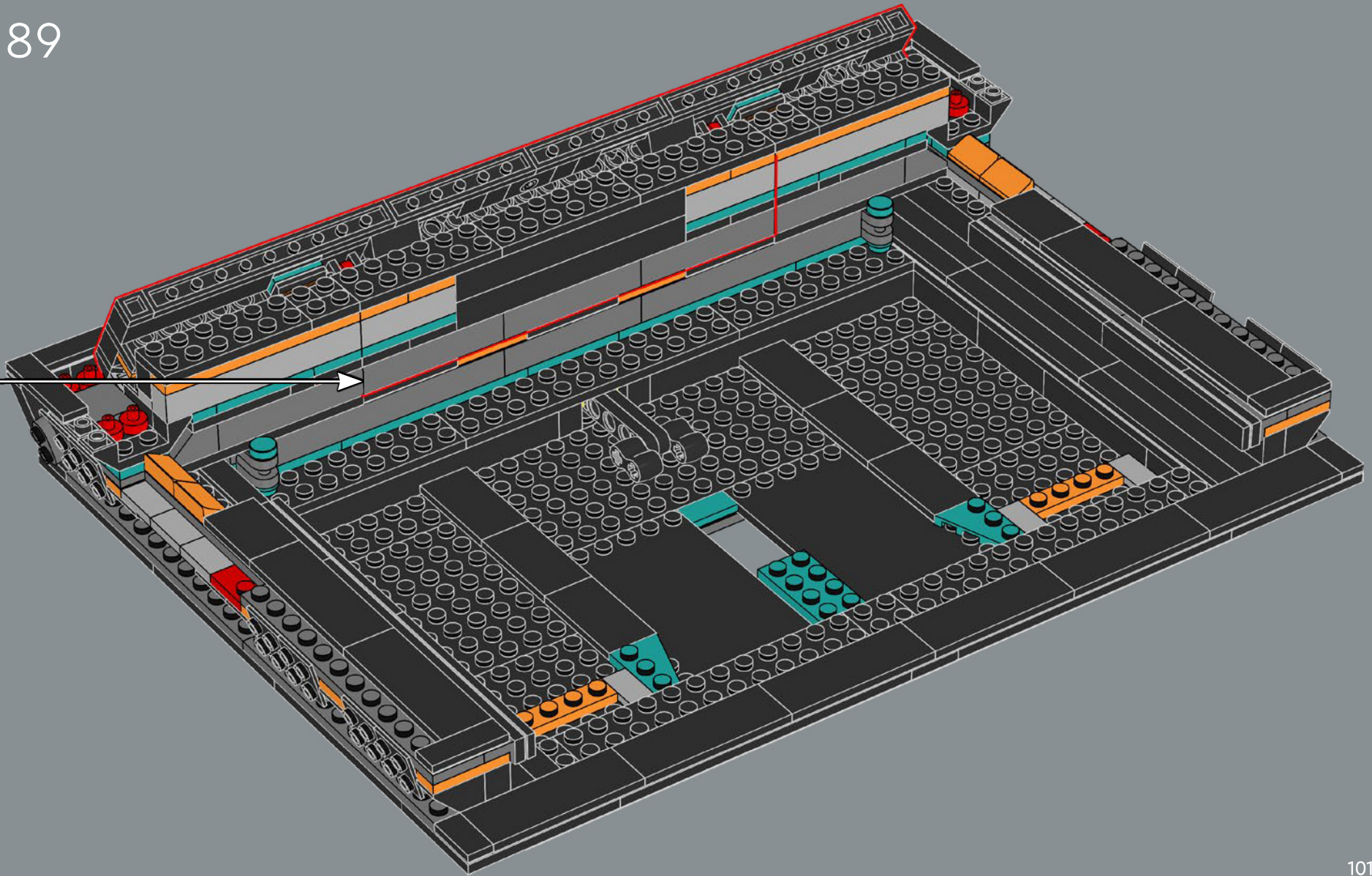



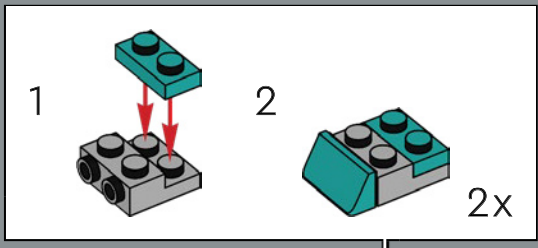
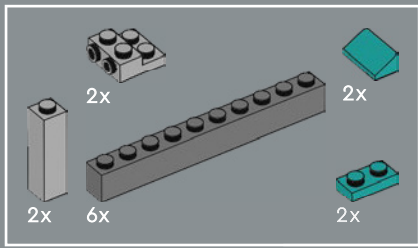

90

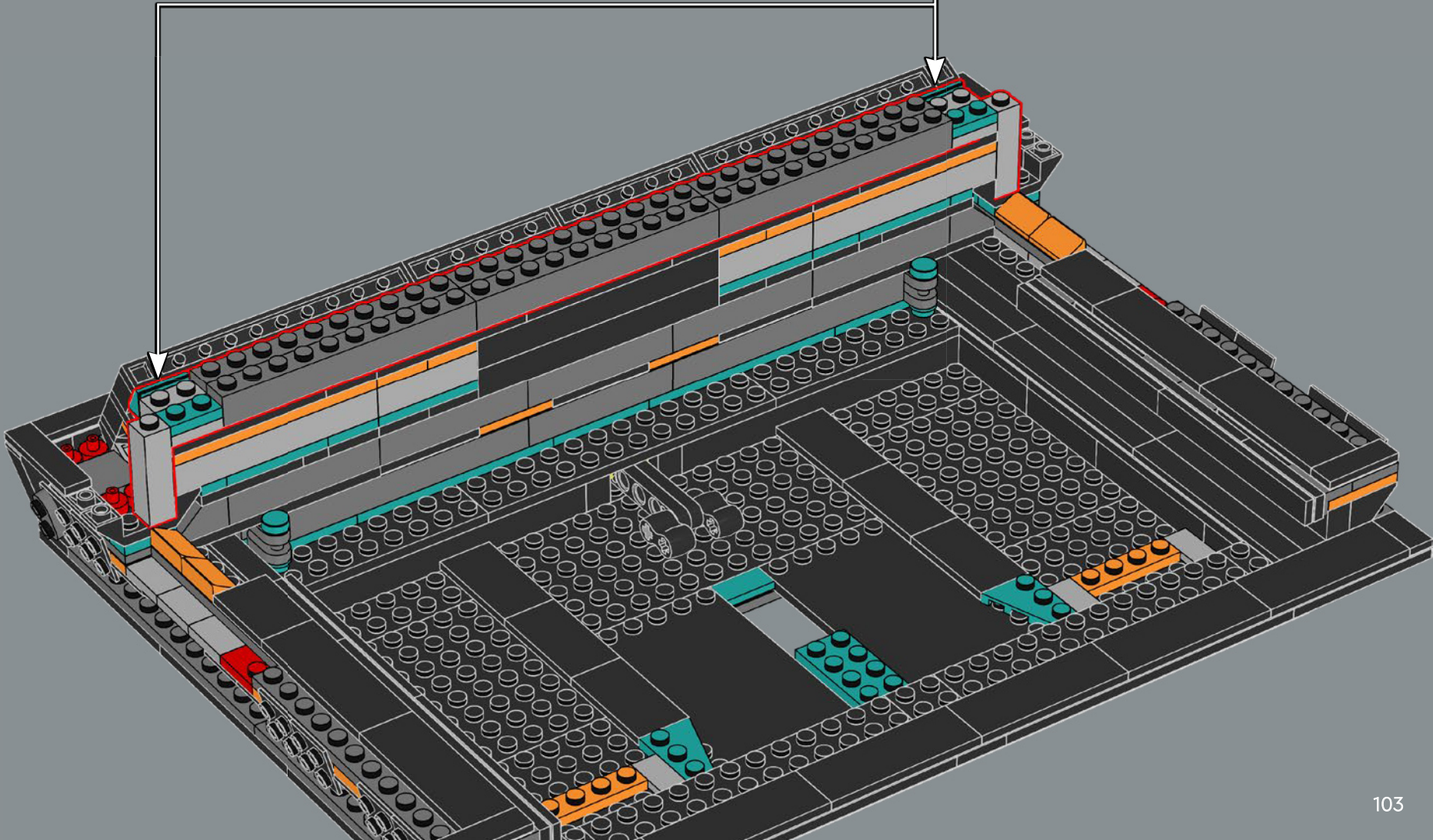

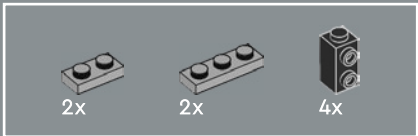

91

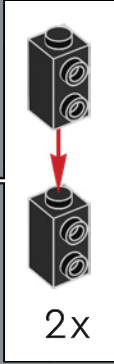
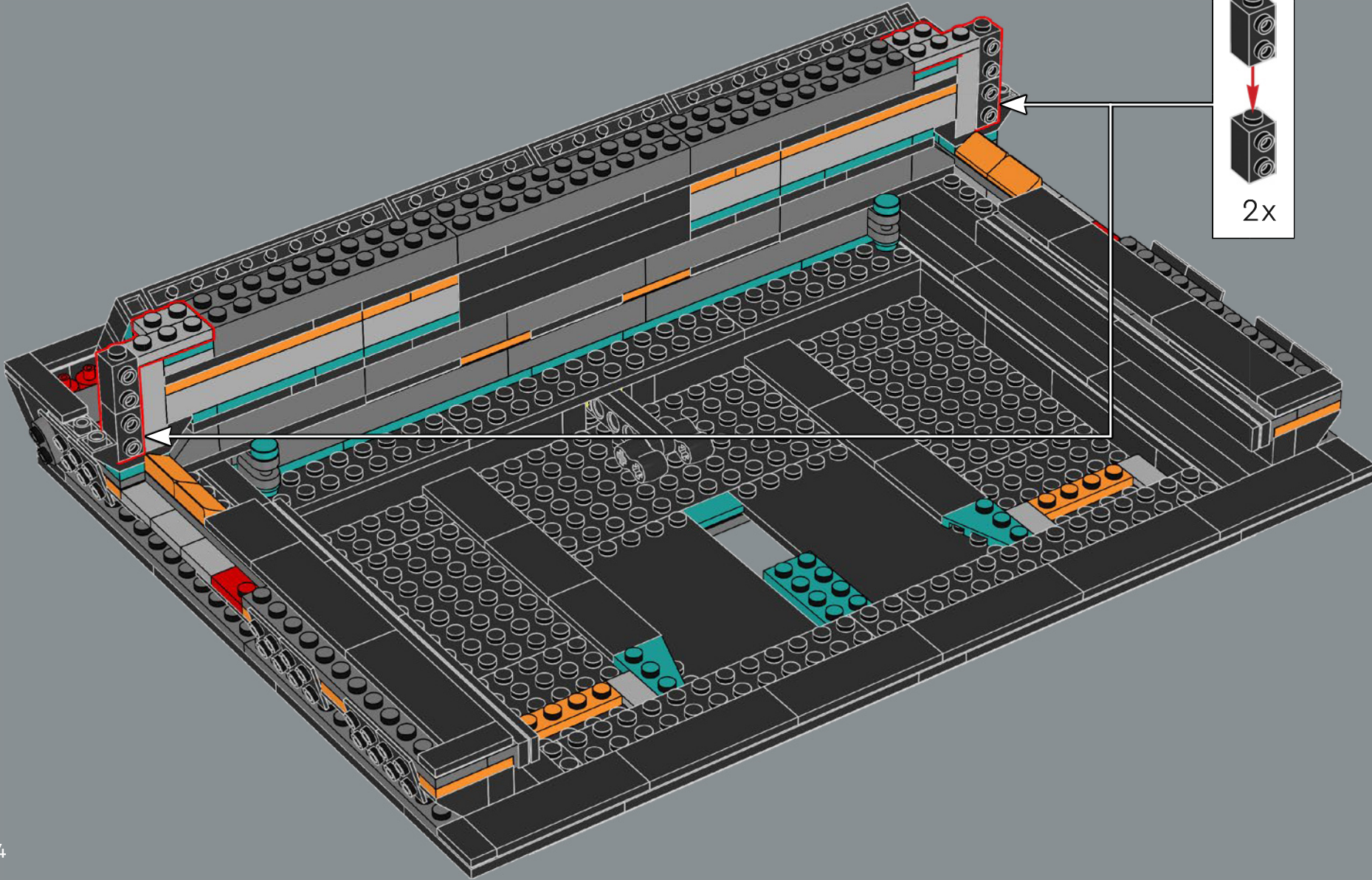

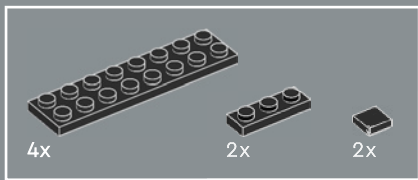

92

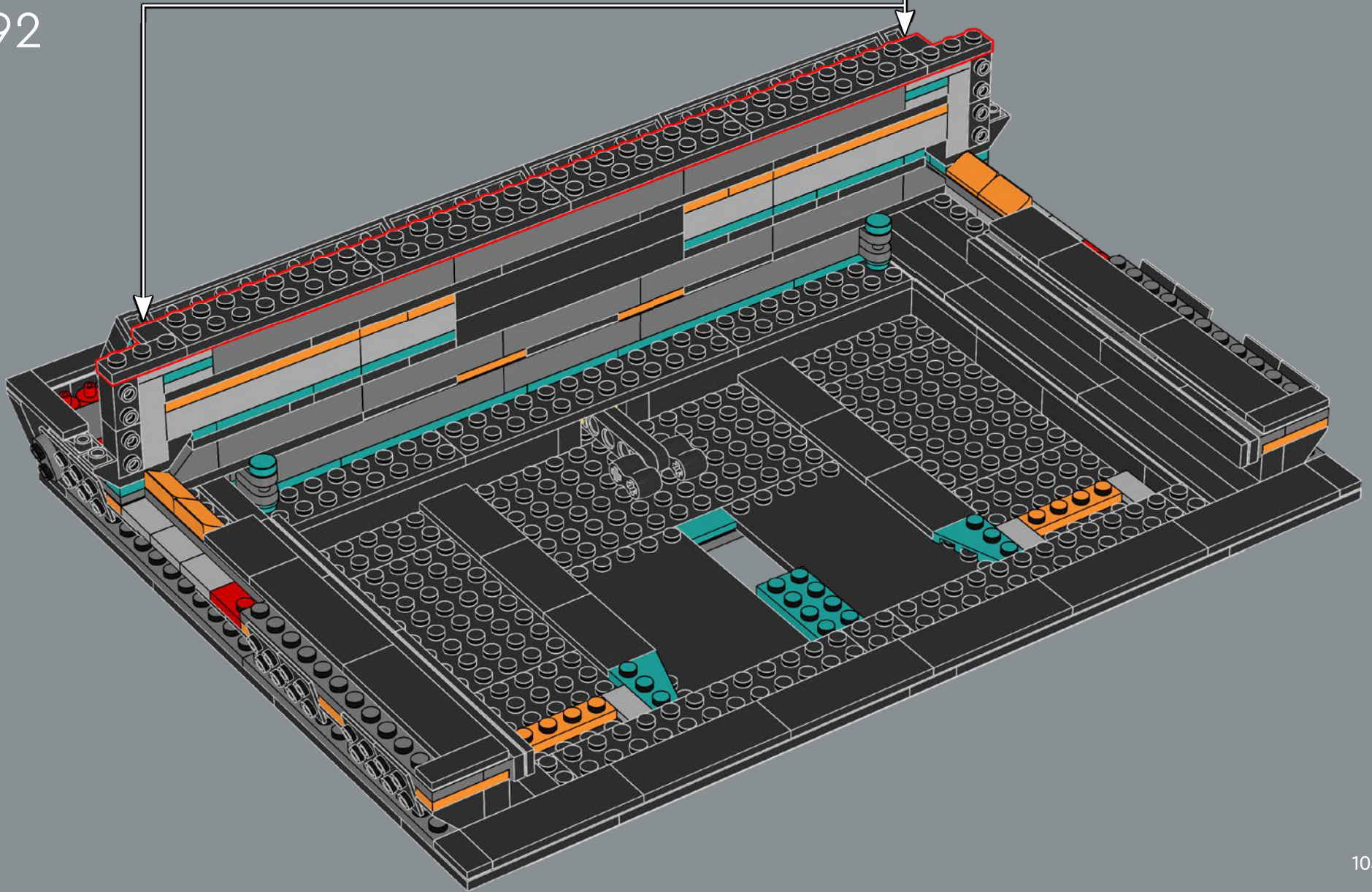

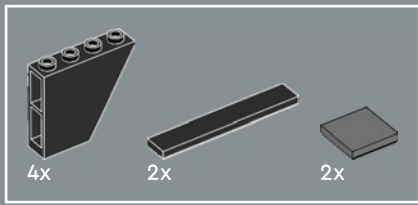

93

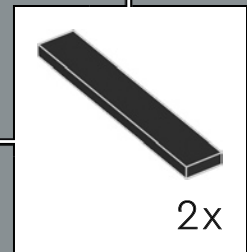
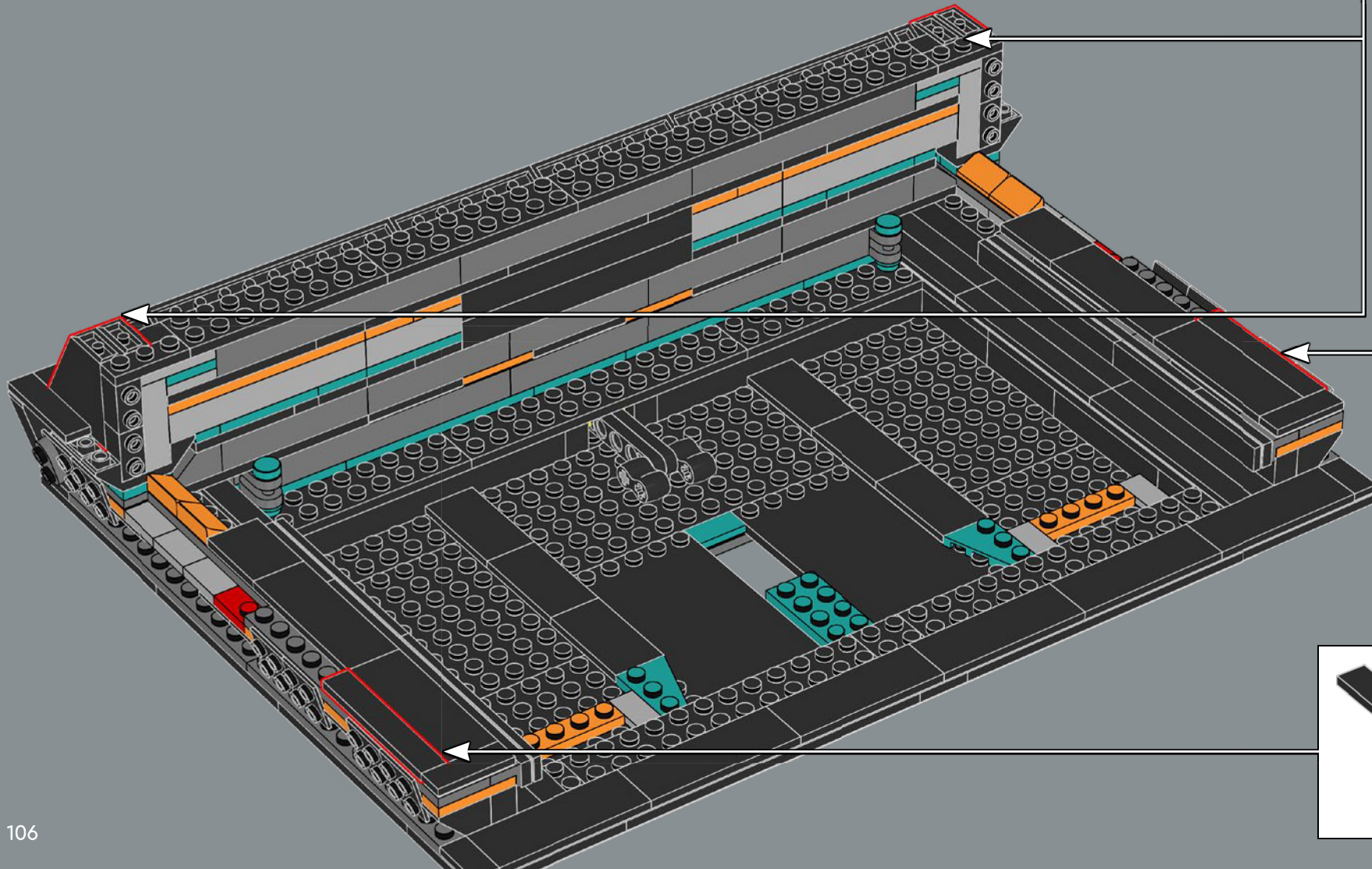
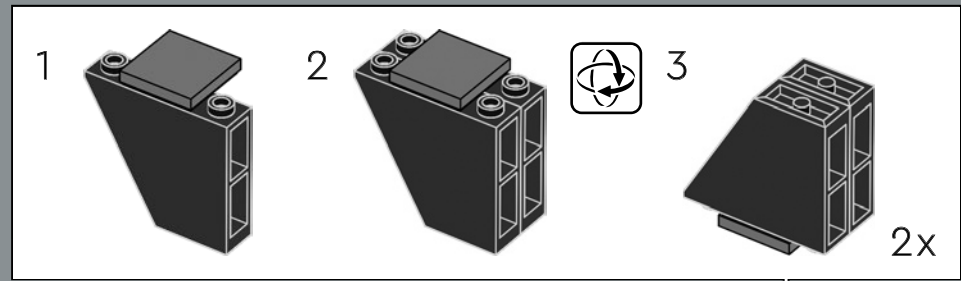

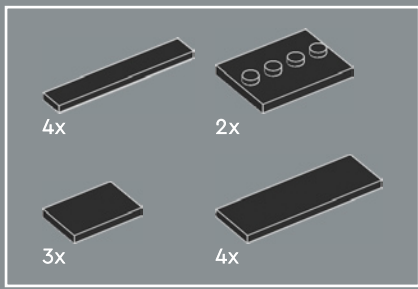

94

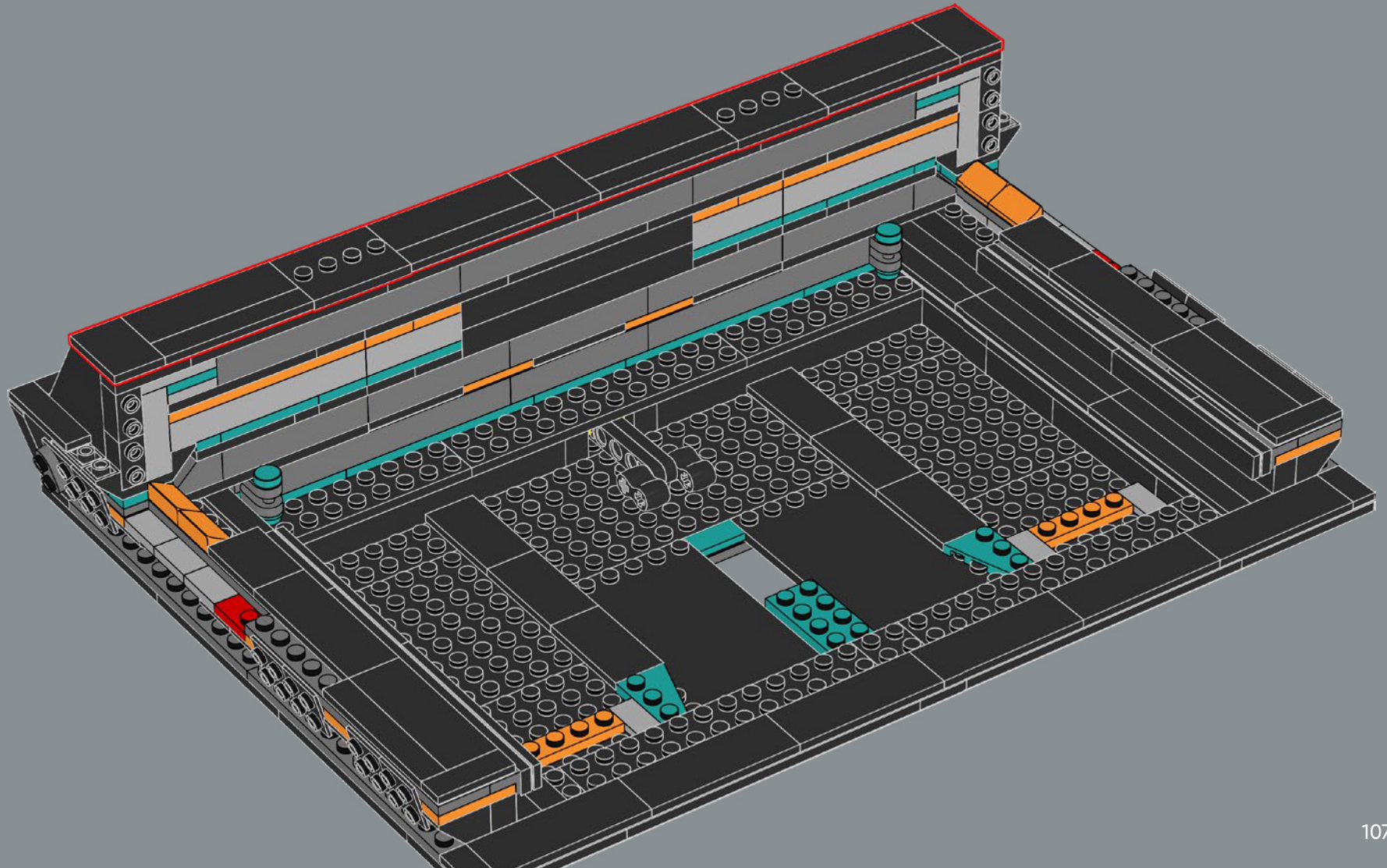

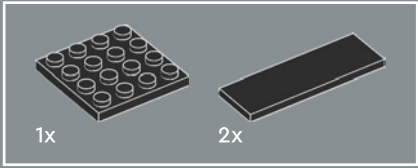
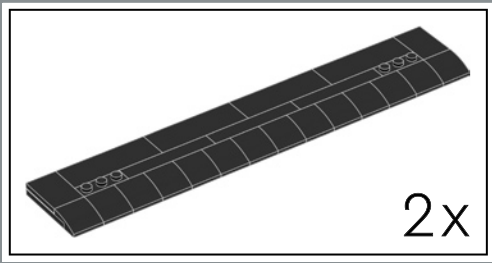

95

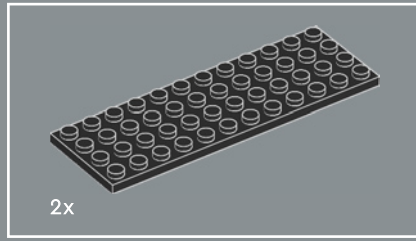
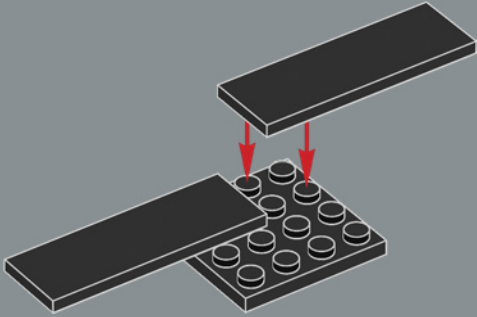

96

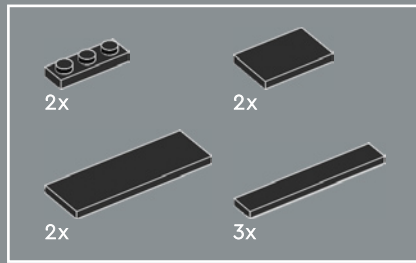
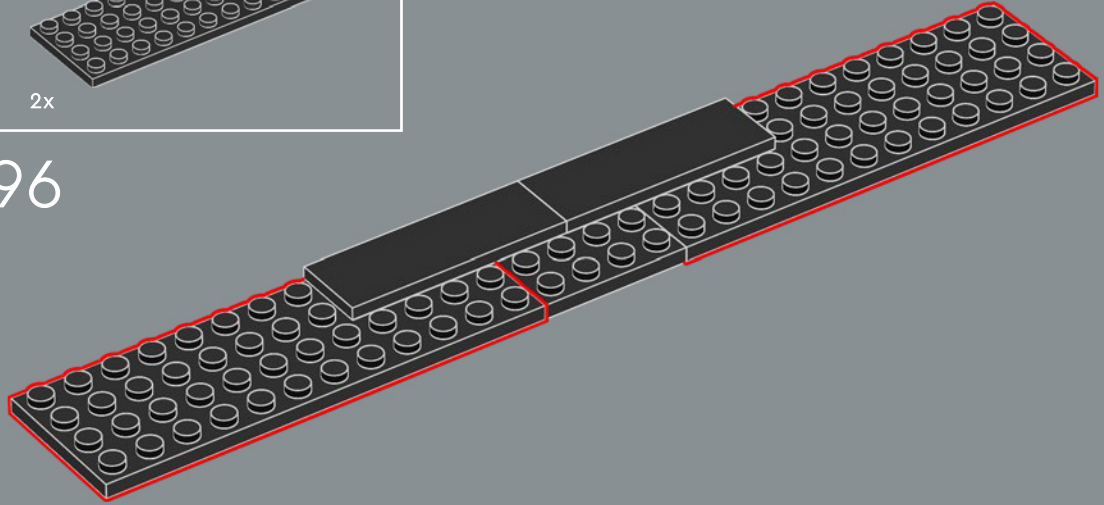

97

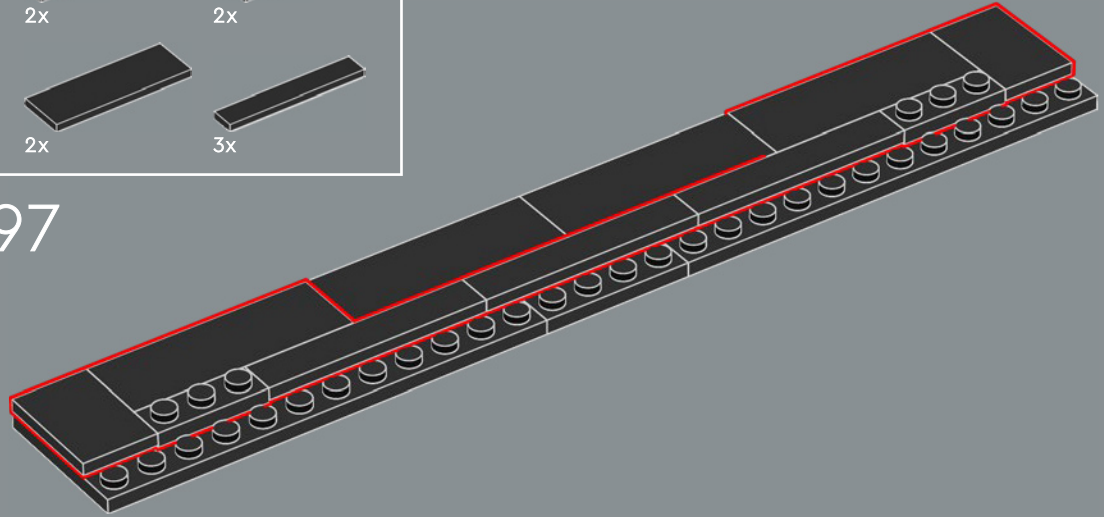



98

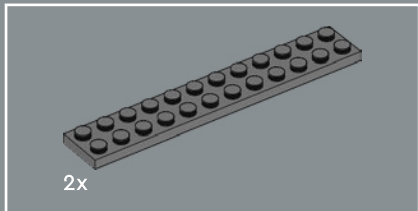
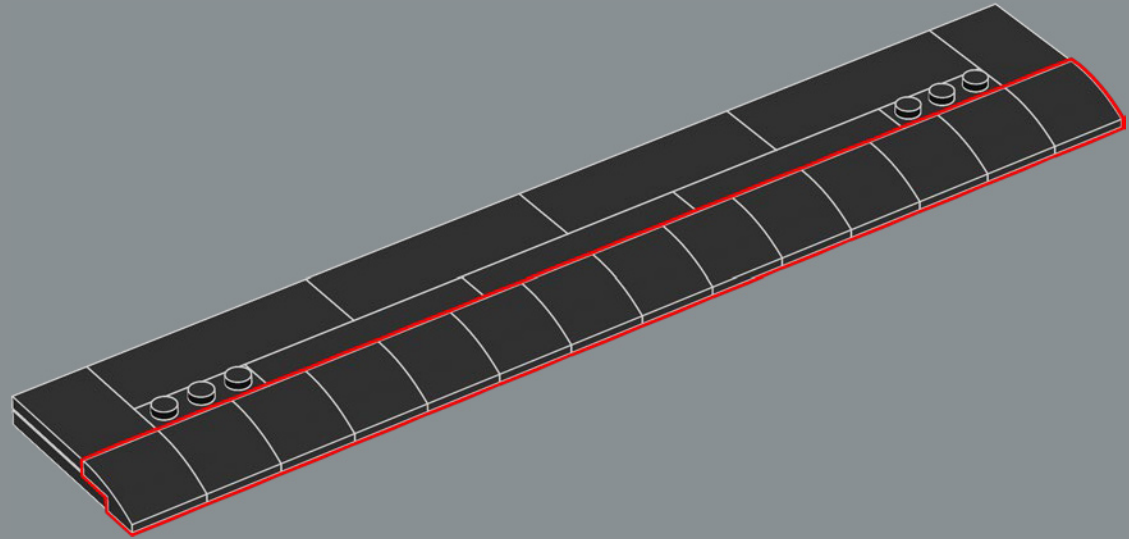

99

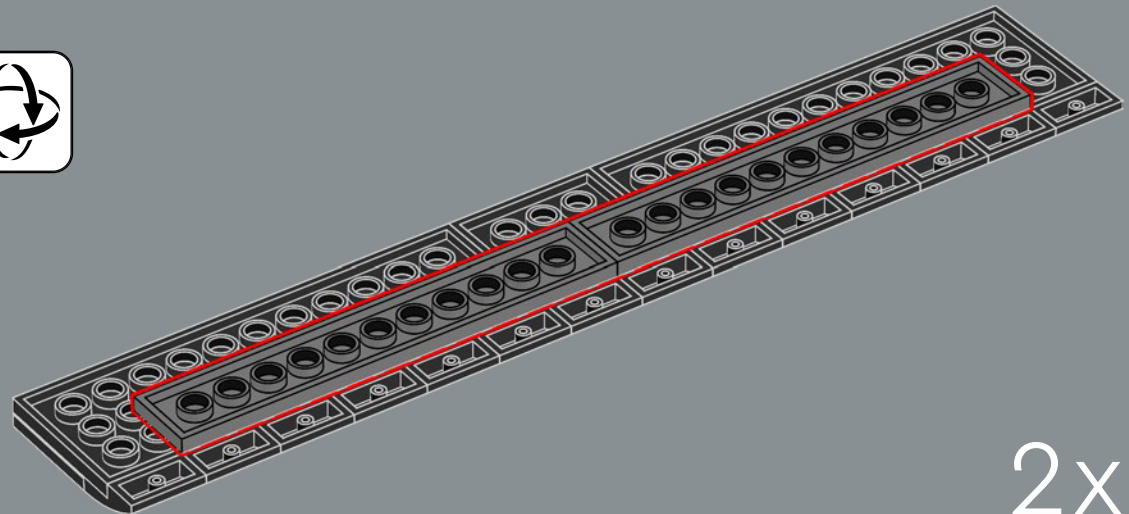

2x

100

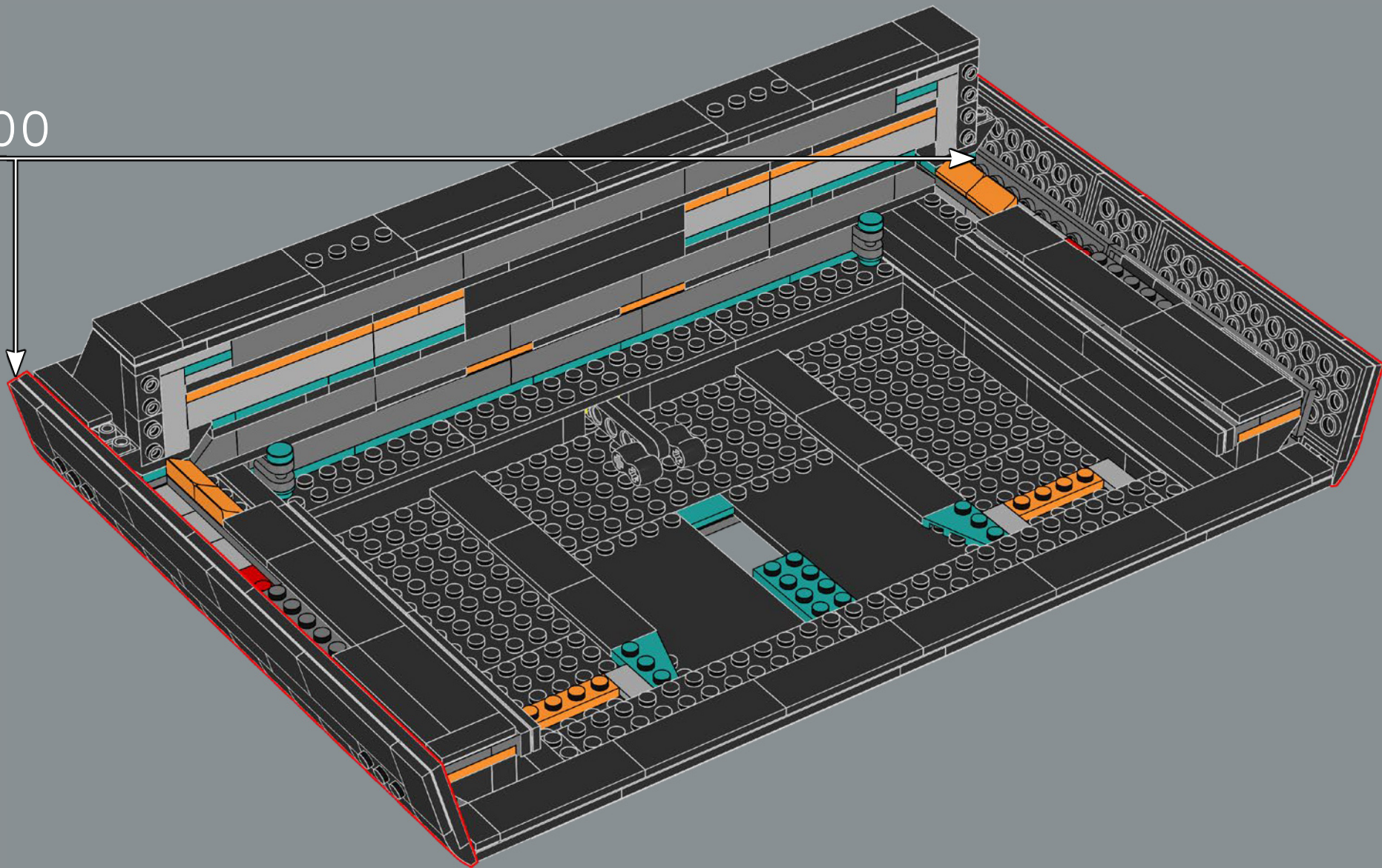

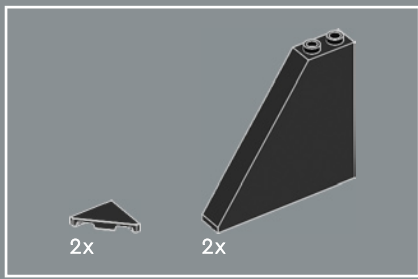

101

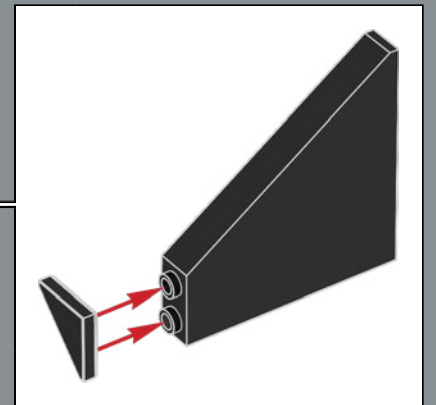
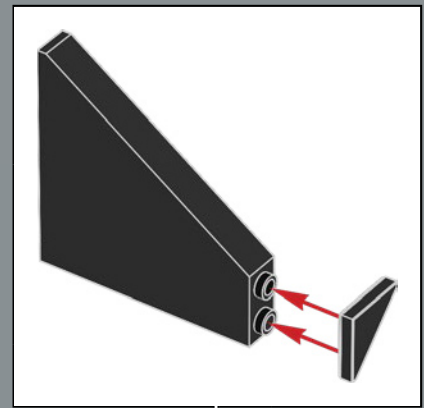
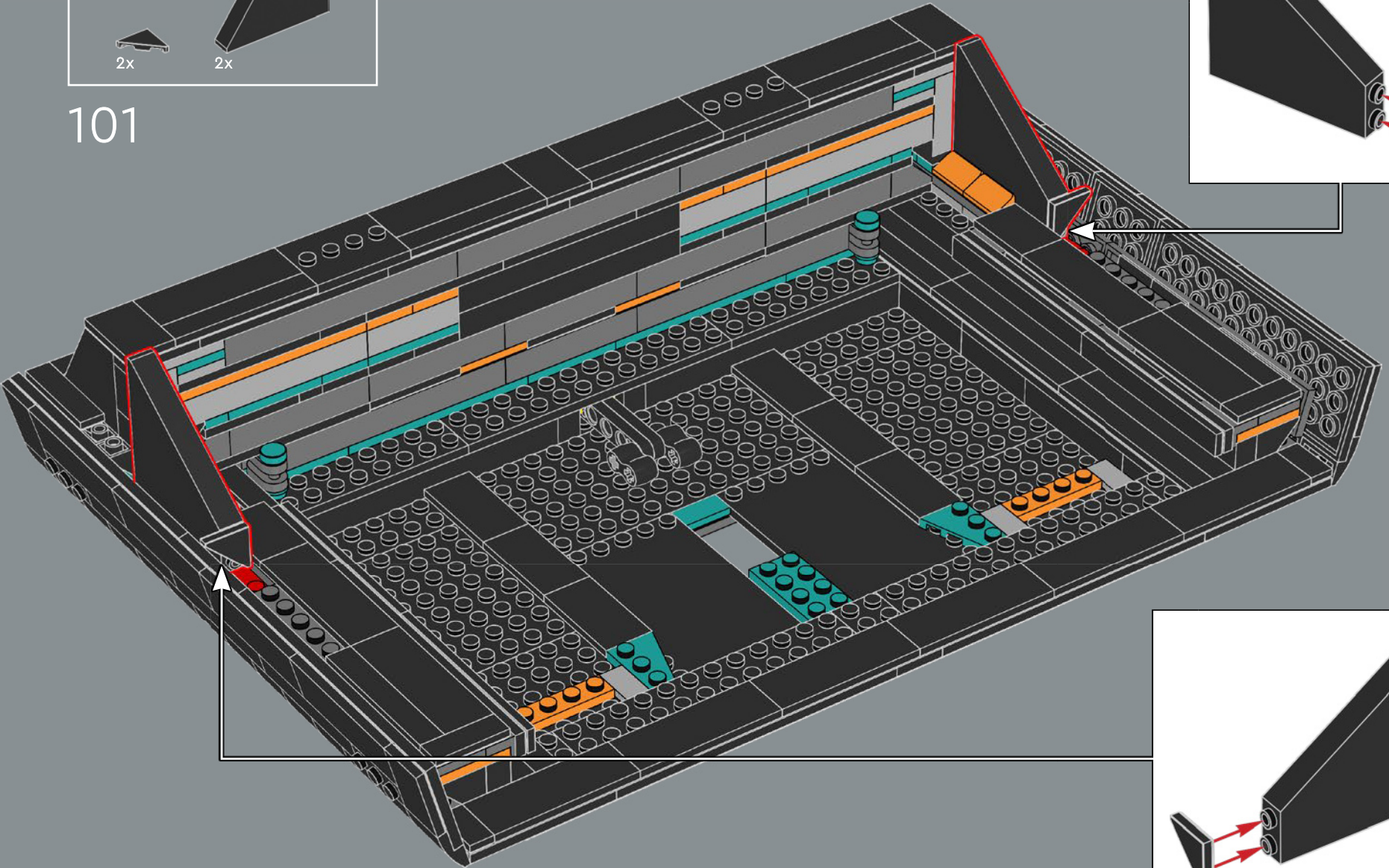

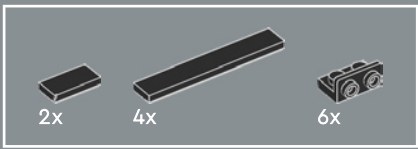

102

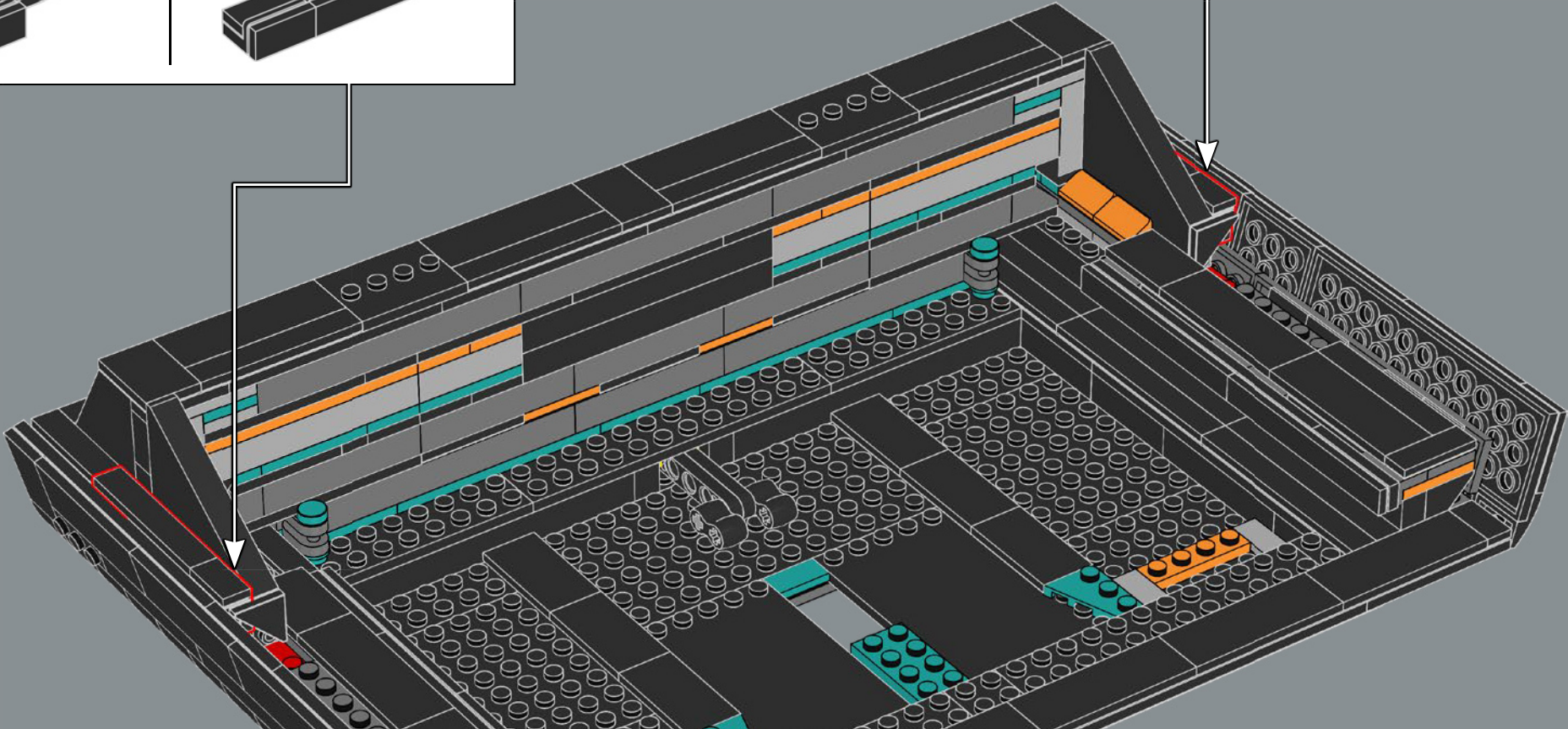
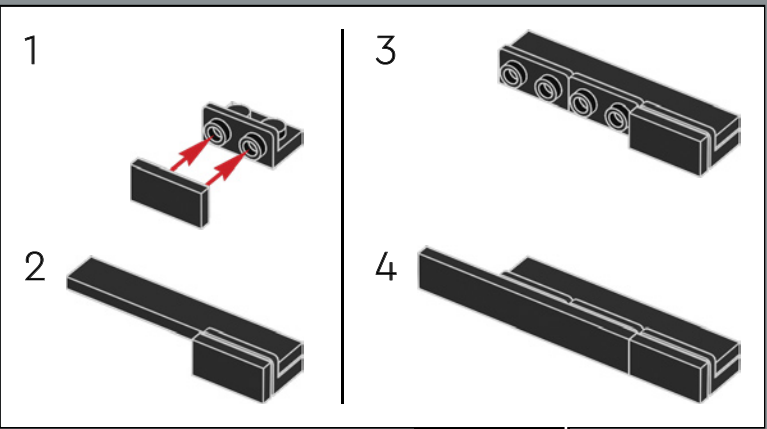
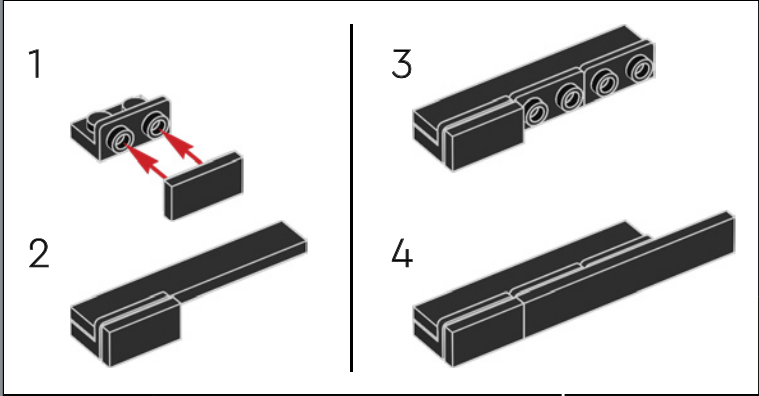

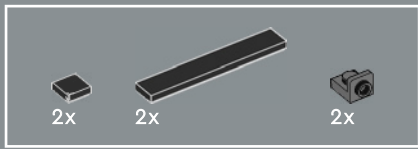

103

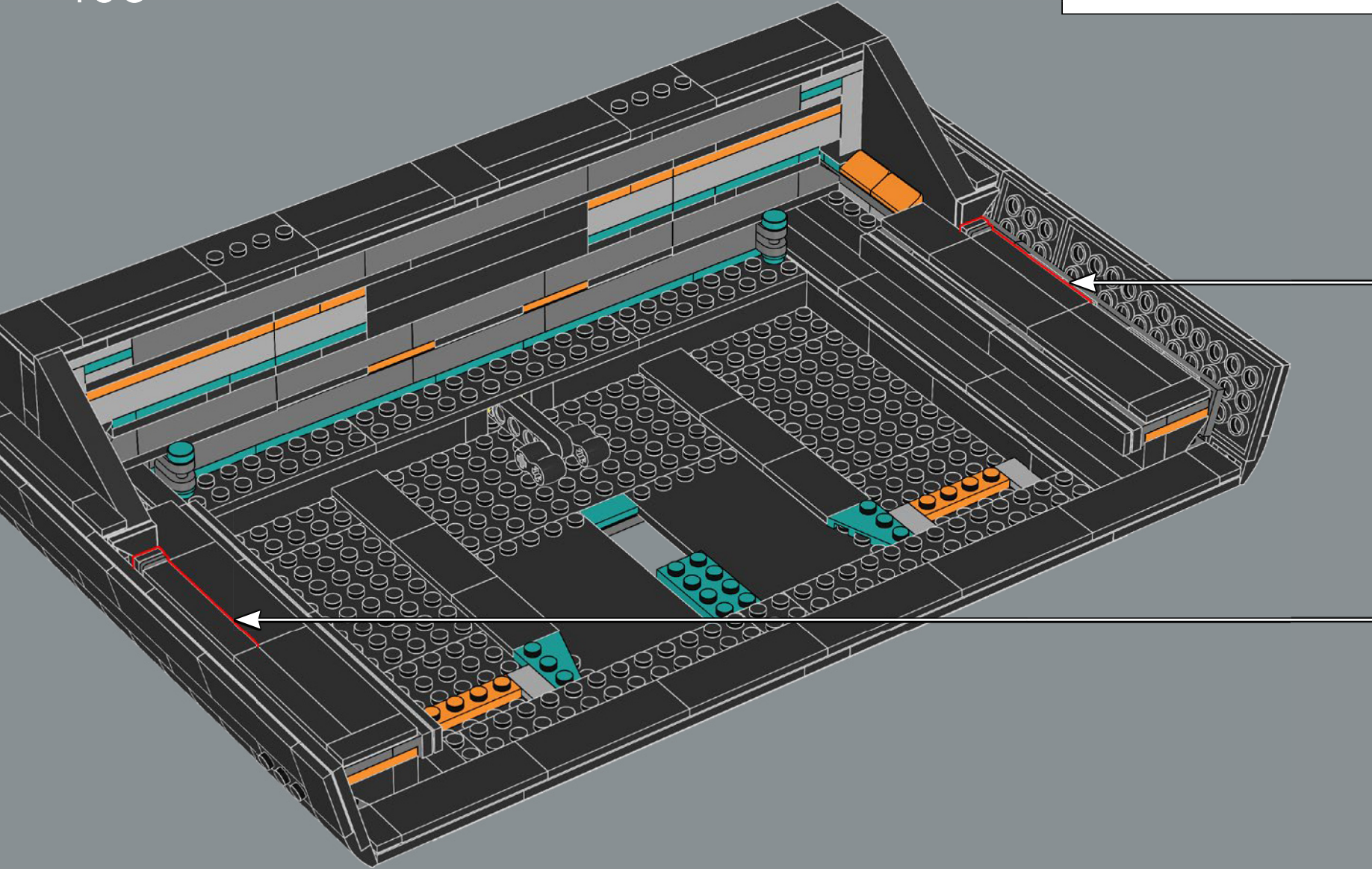
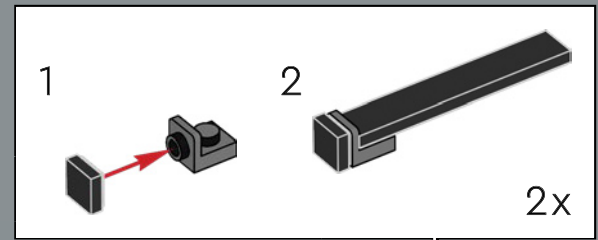

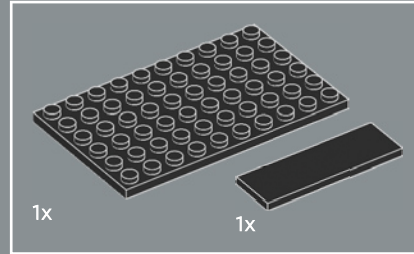
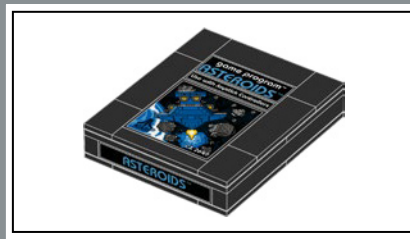

1

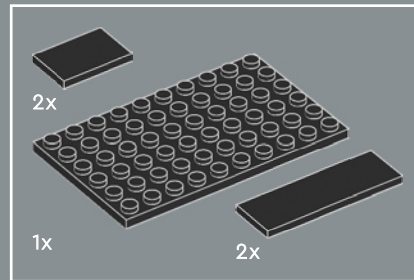
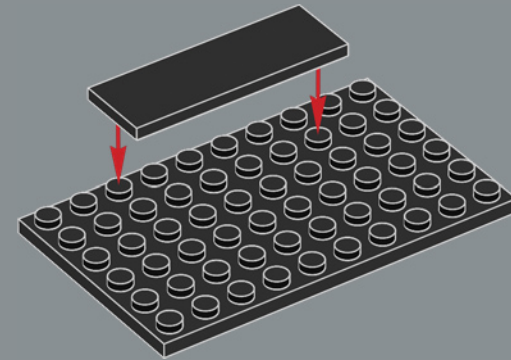

2

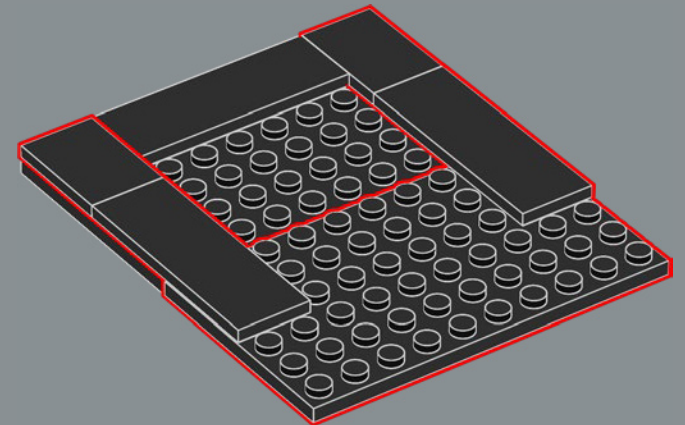

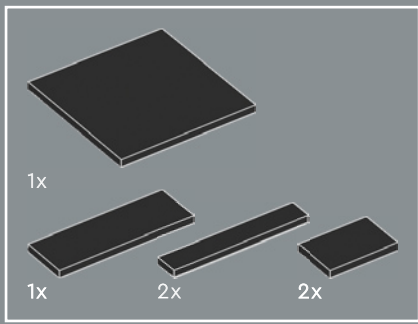

3

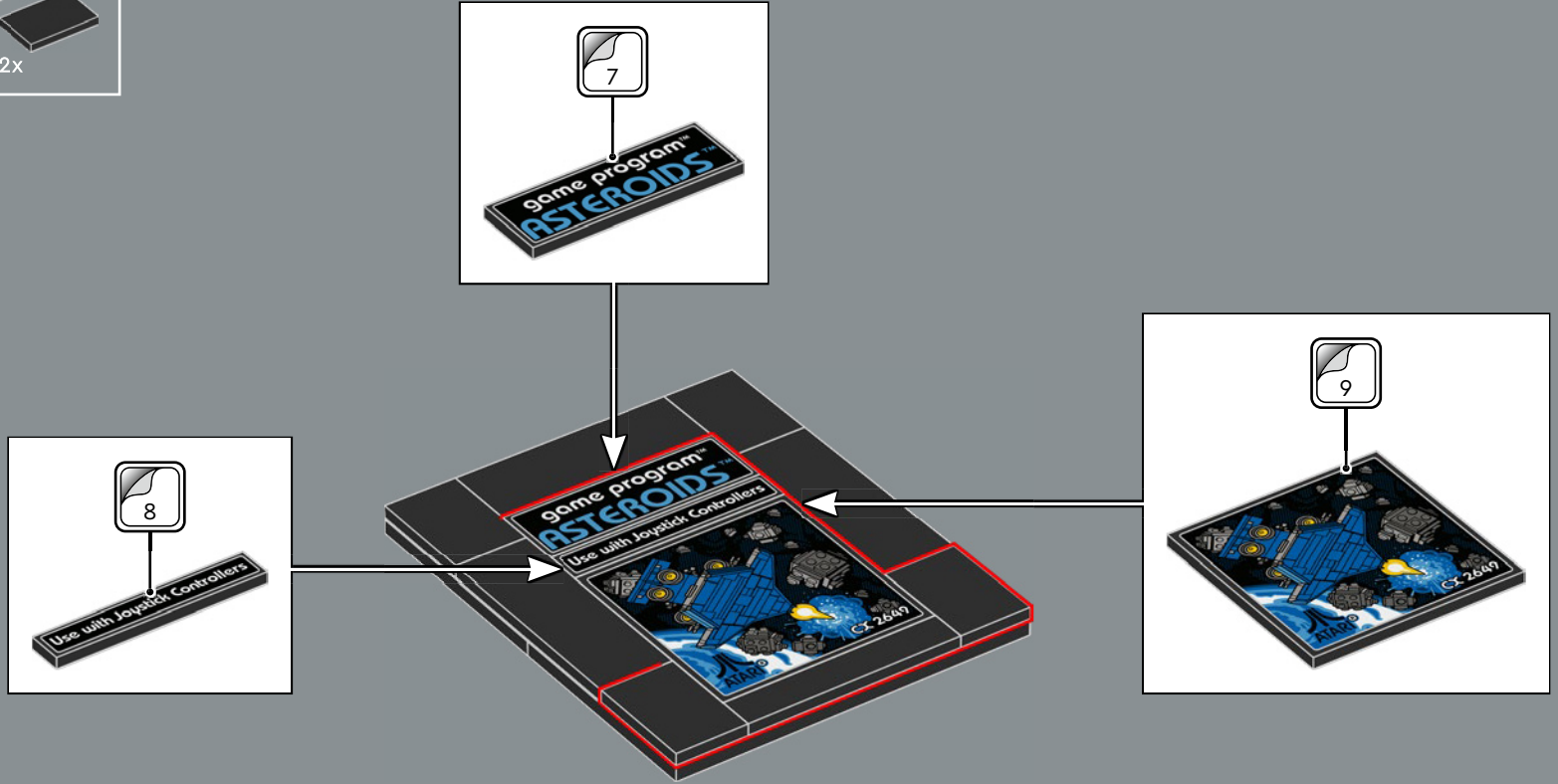

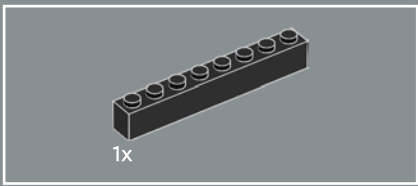

4

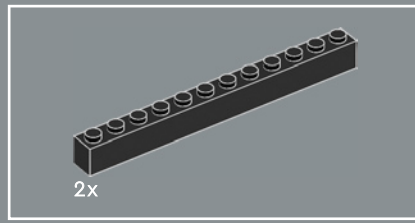
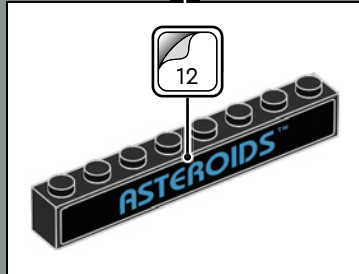
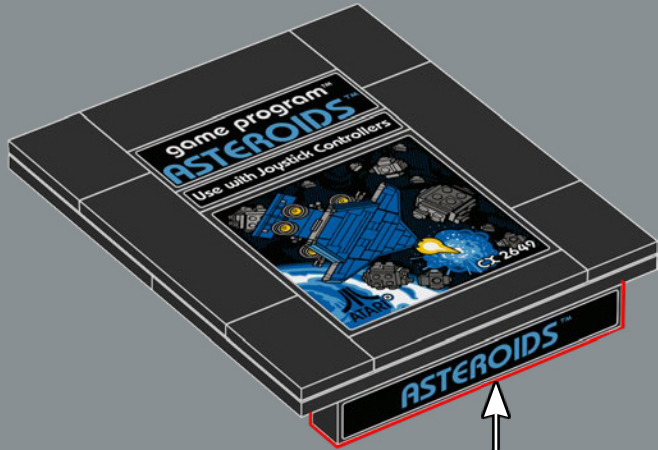

5

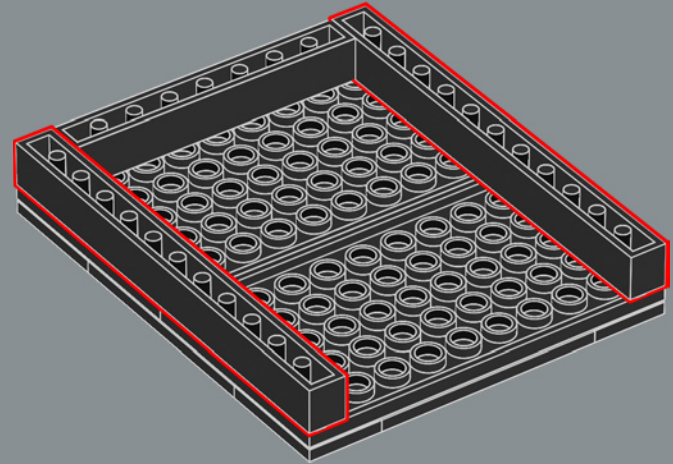

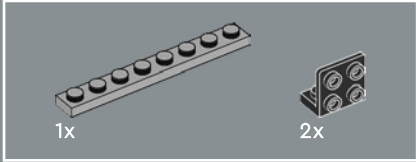
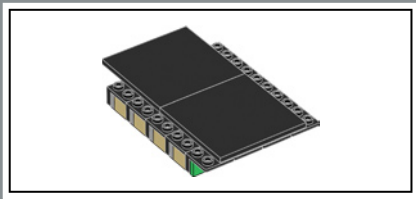

6

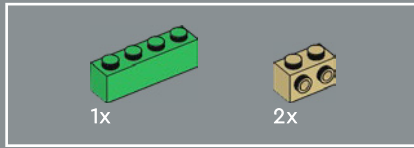
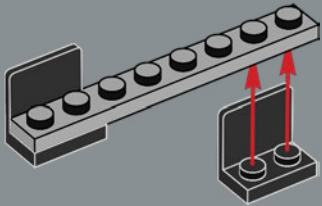

7

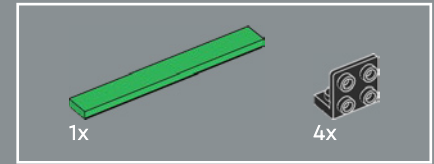
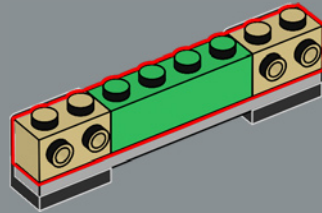

8

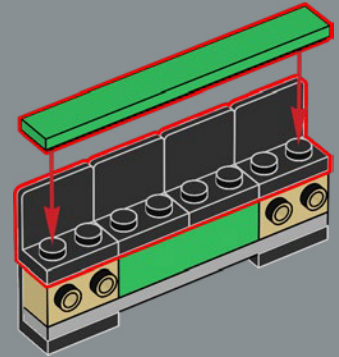

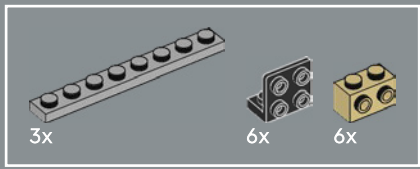

9

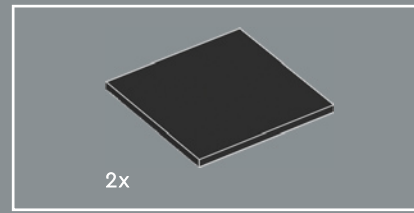
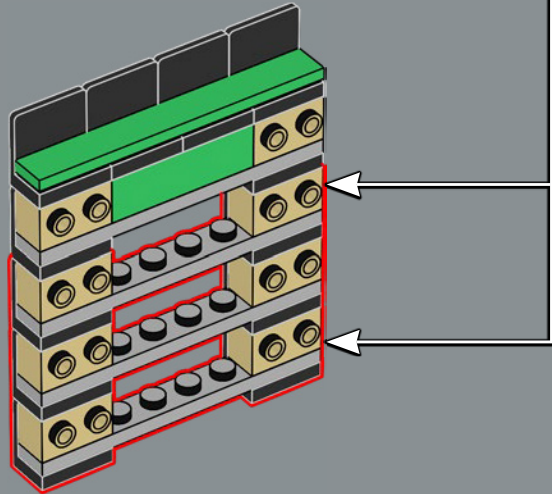
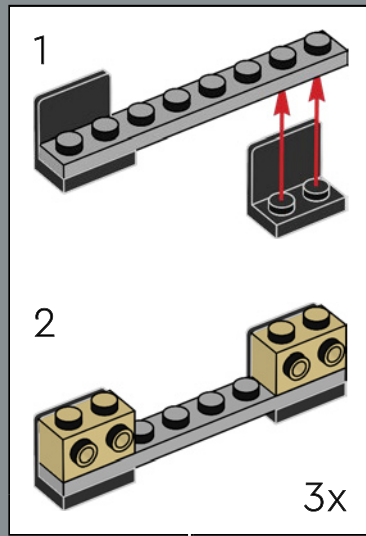

10

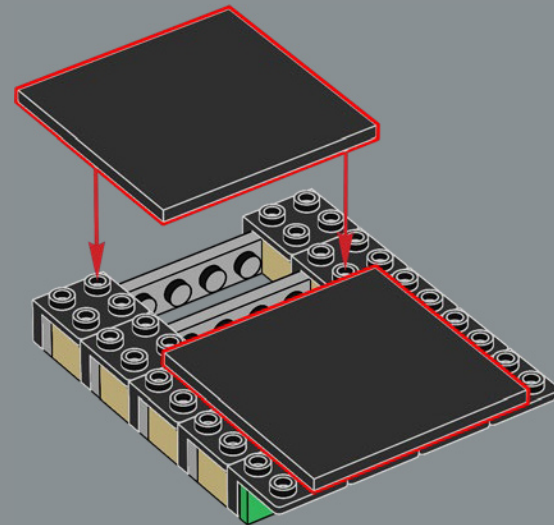

11

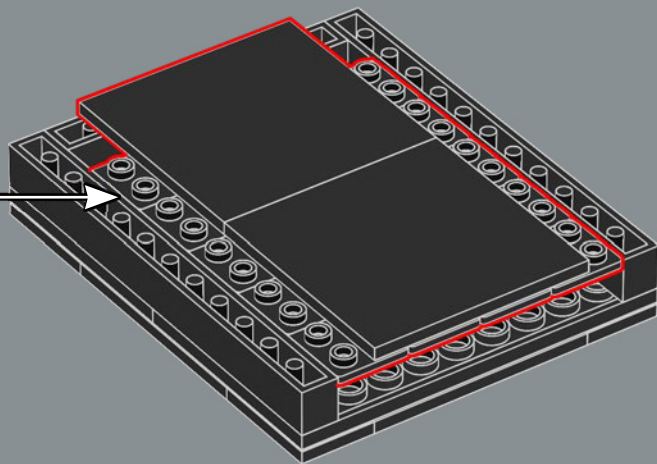

All cartridge artwork has been abstracted to include LEGO® elements, but the Asteroids artwork is particularly special because it features the new LEGO 10497 Galaxy Explorer. 

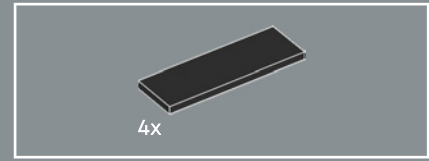

12

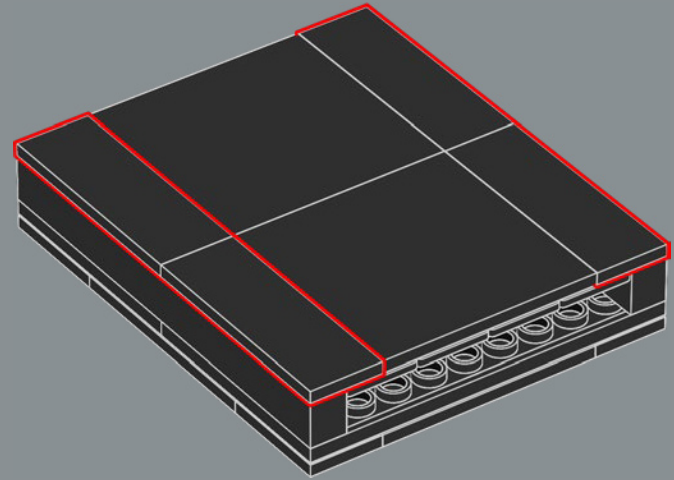

13



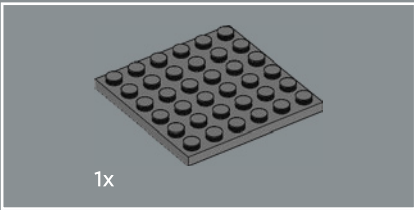
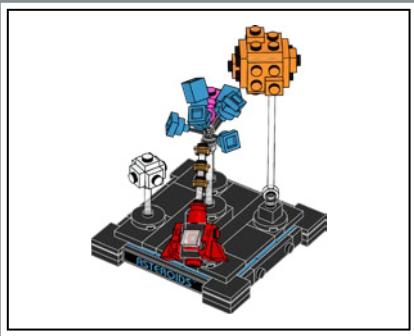

1

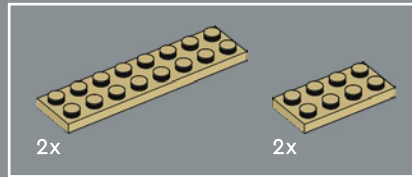
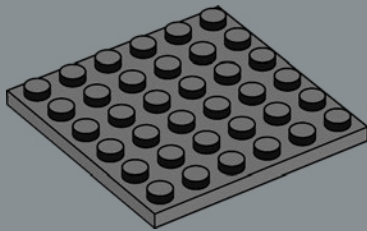

2

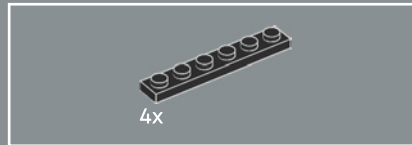
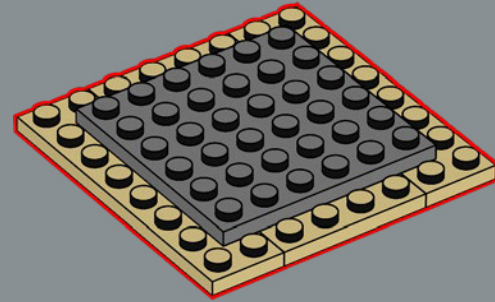

3

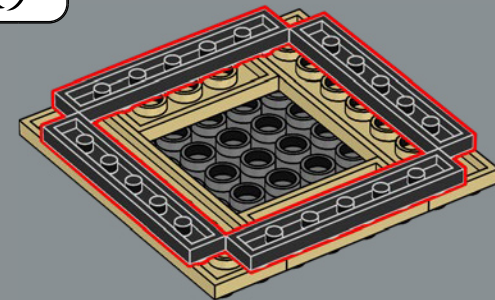

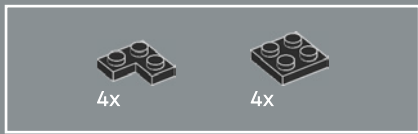

4

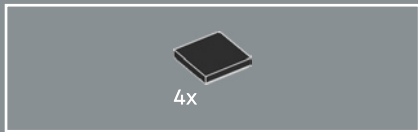
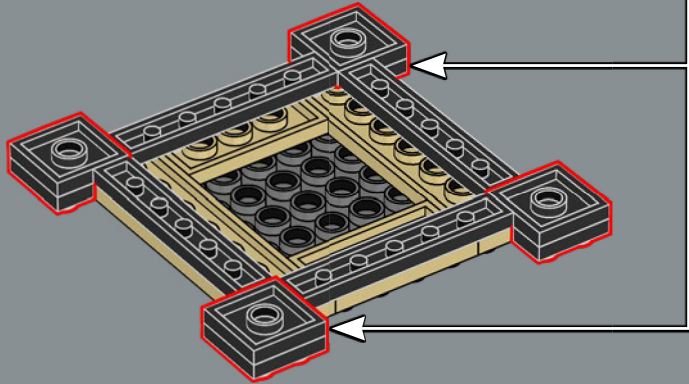
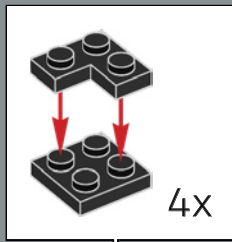

5

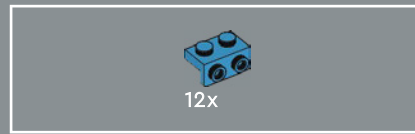
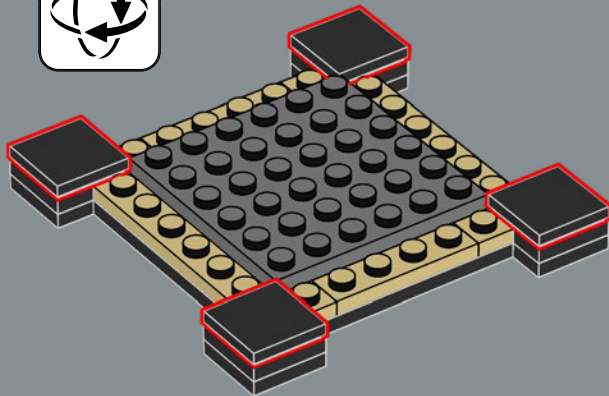

6

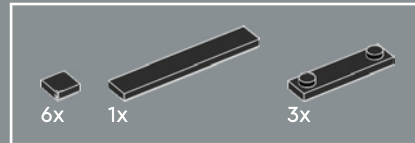
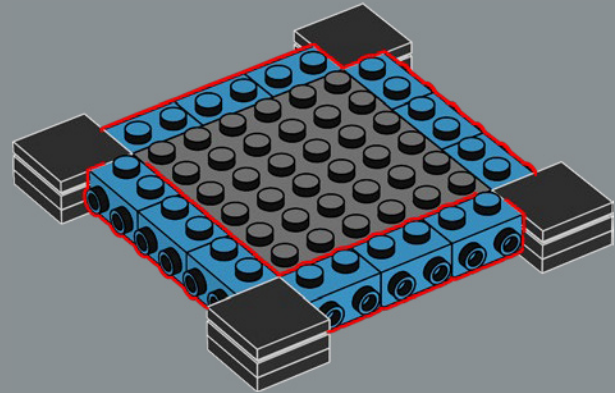

7

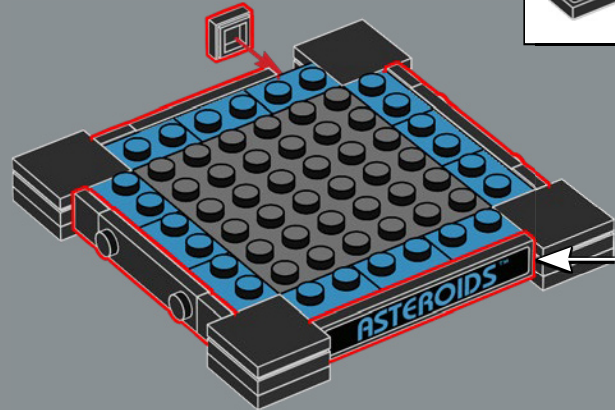
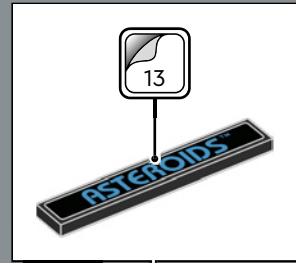

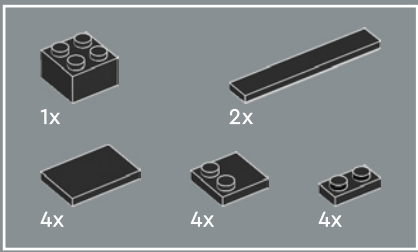

8

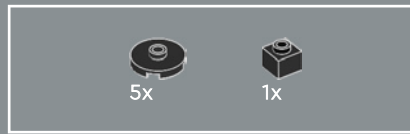
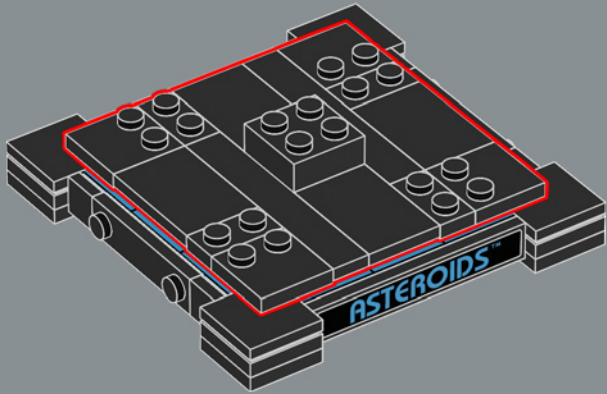

9

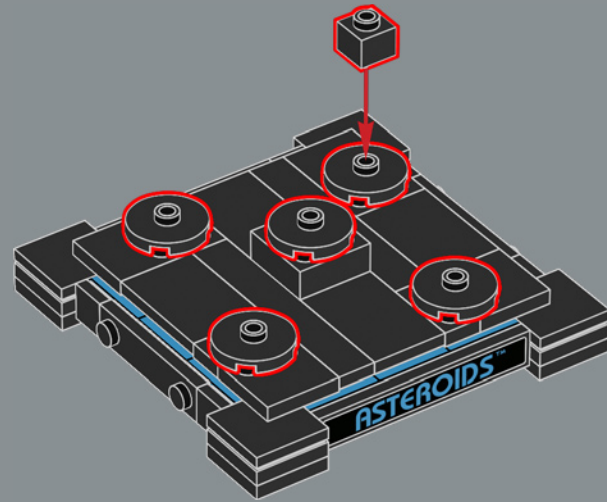

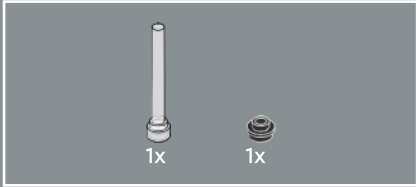
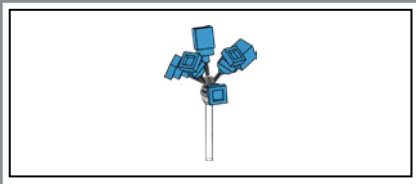

10



11

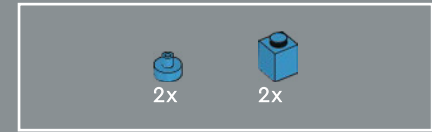
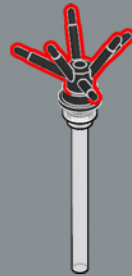

12

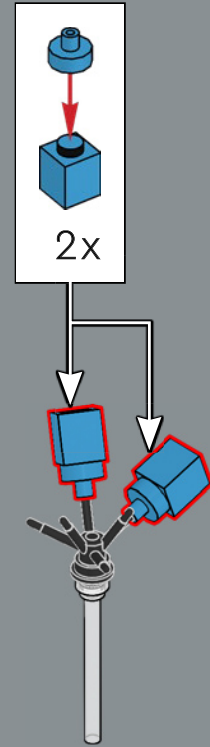

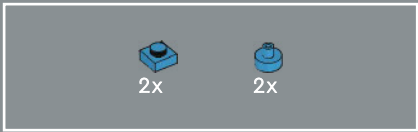

13

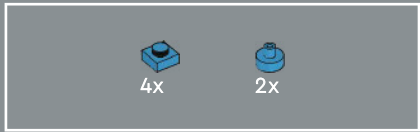
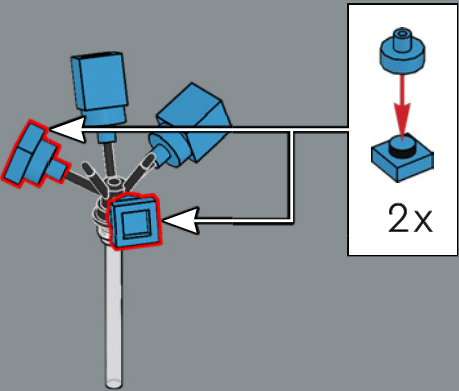

14

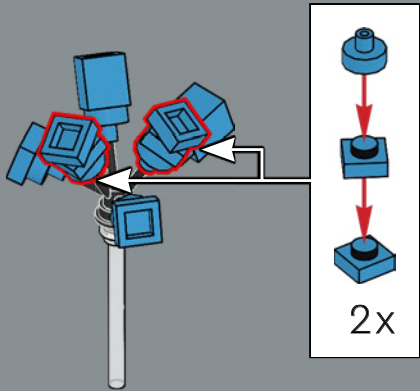

15

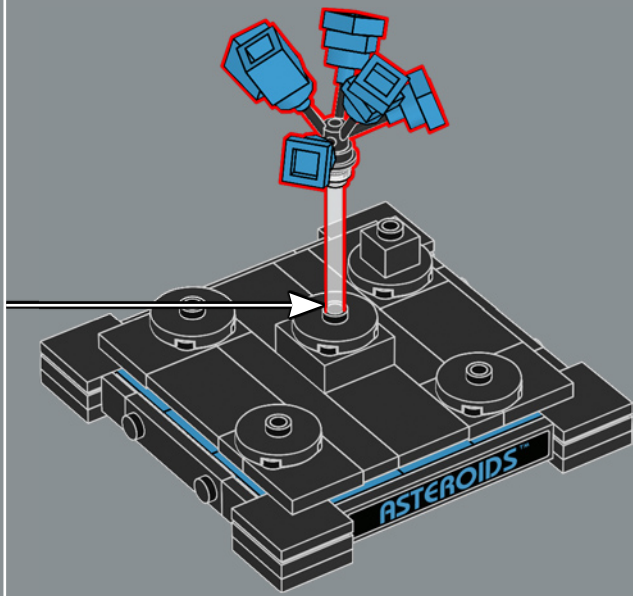

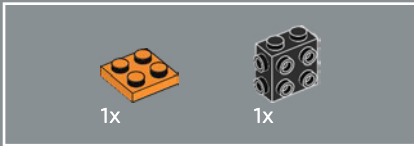
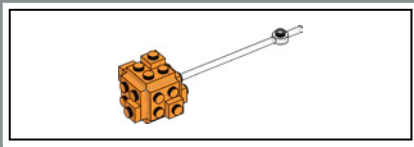

16

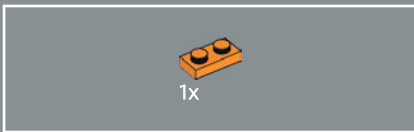
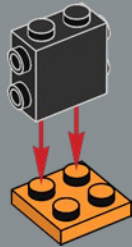

17

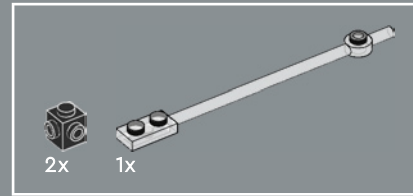
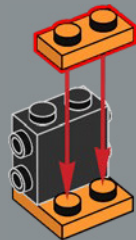

18

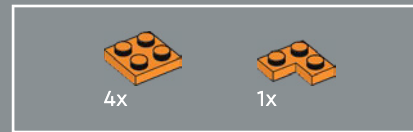
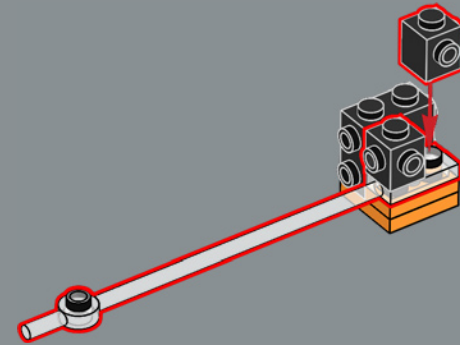

19

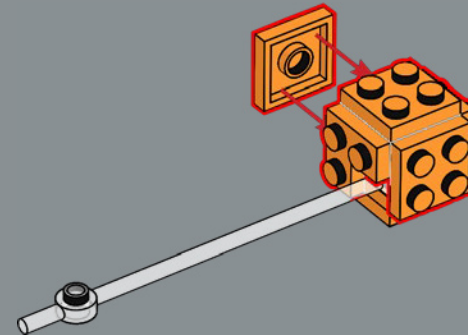



3x

20

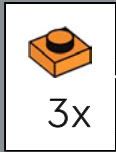

3x

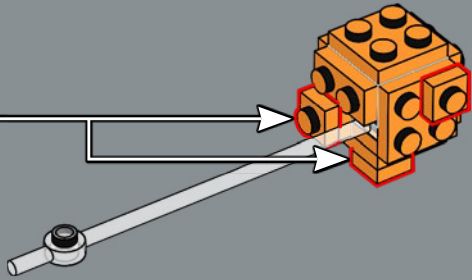

3x

21

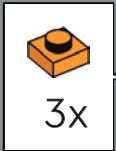

3x

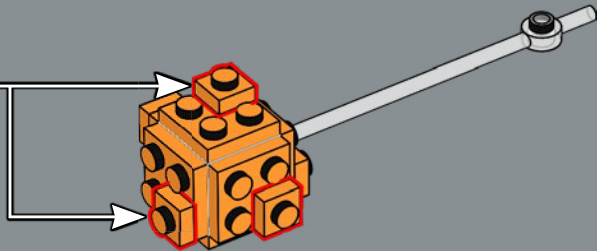

22

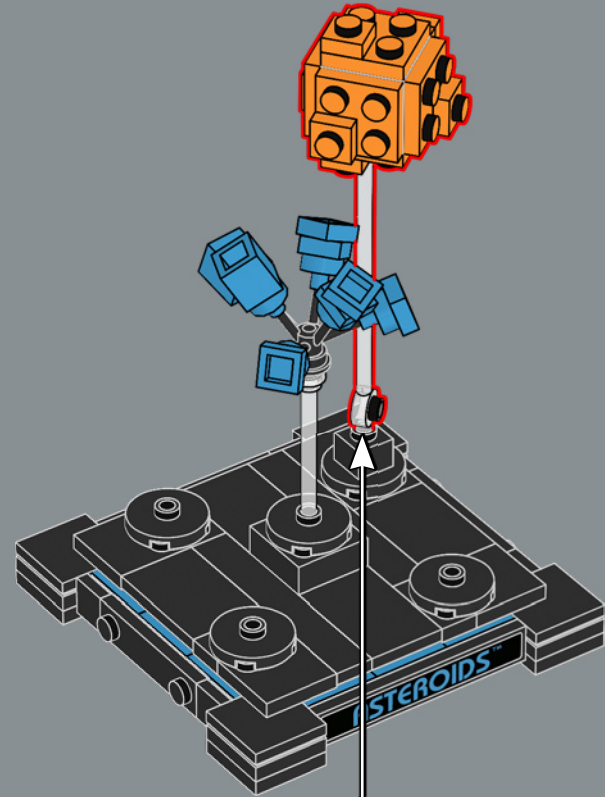

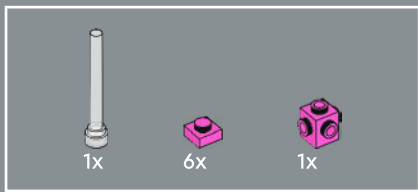

23

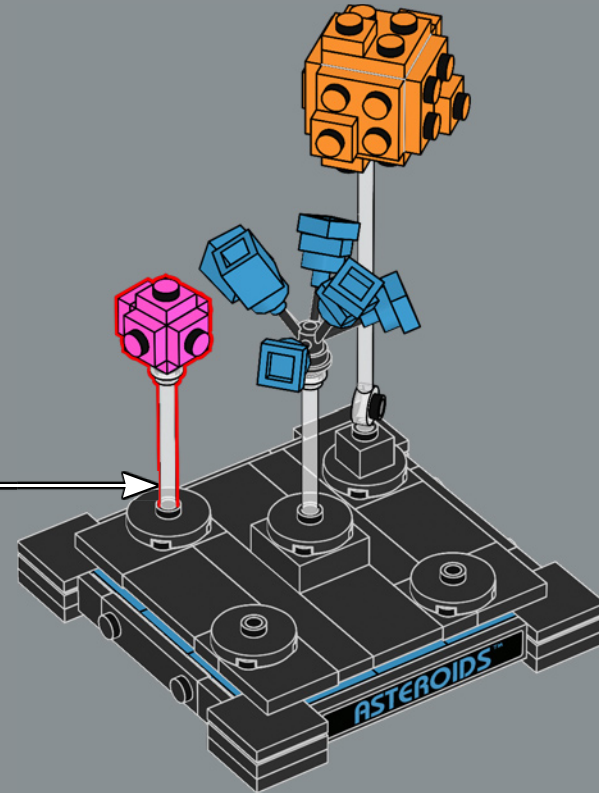
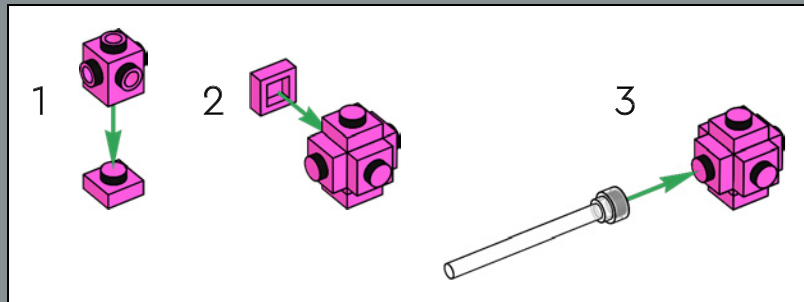

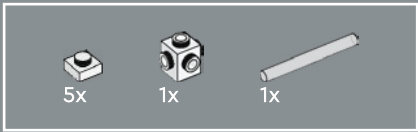

24

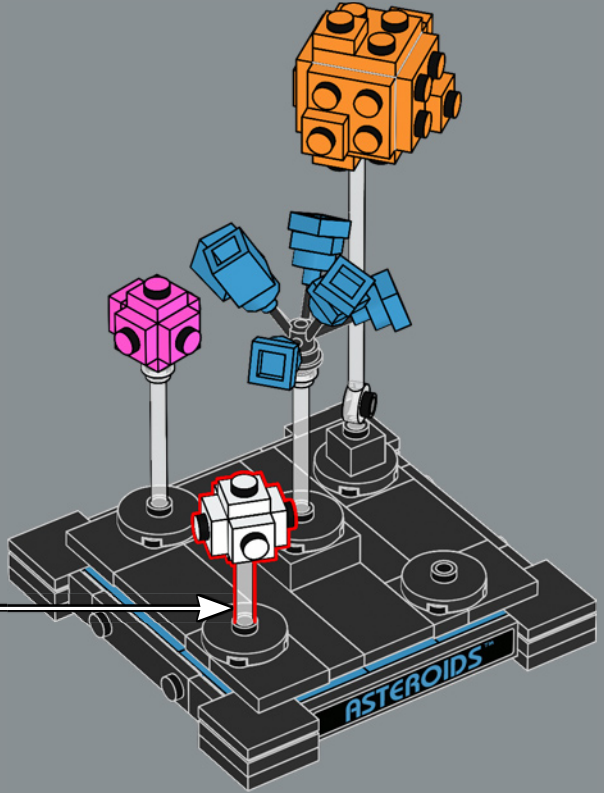
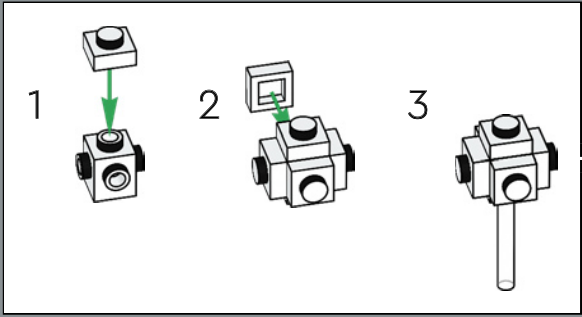

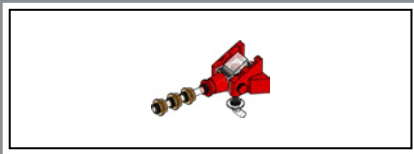

25

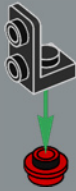

26

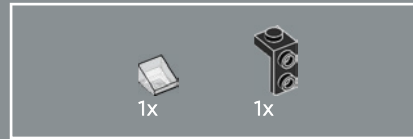

27

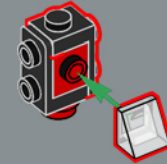

28





2x

29

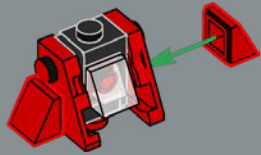

1x



1x

30

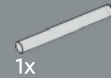
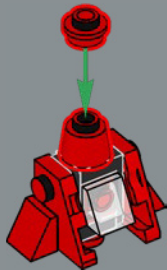

1x

31



3x

32



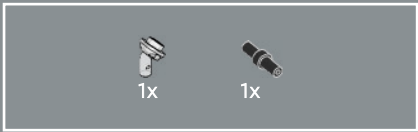

33

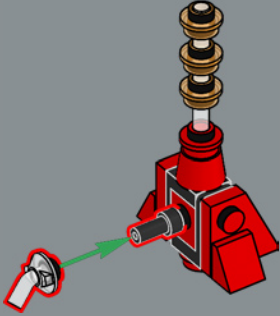

34

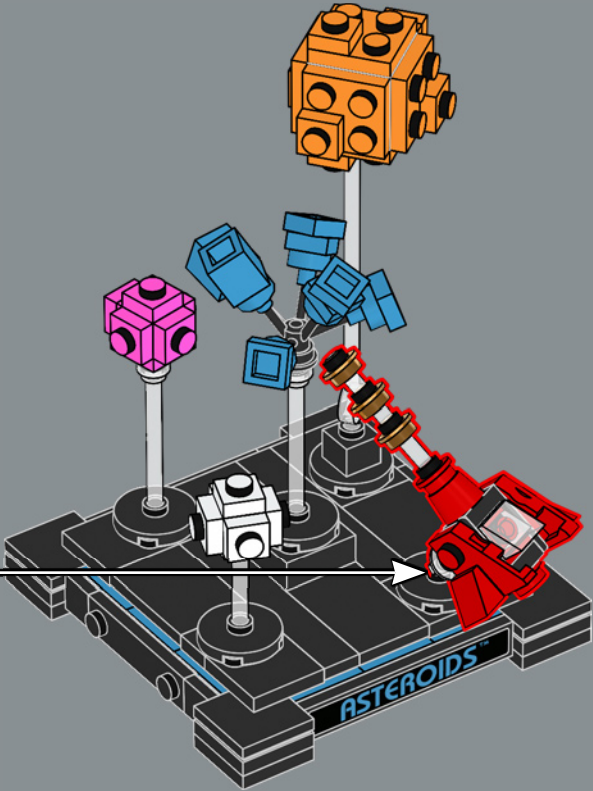

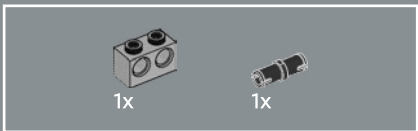
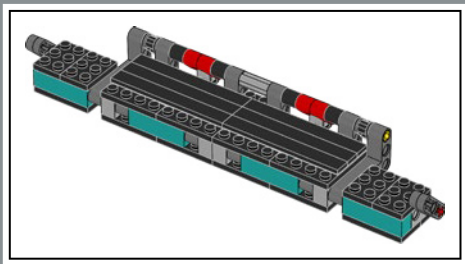

104

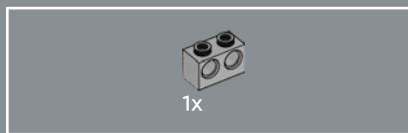
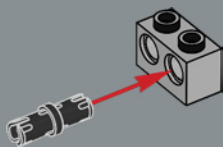

105

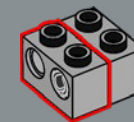

106

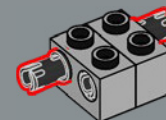

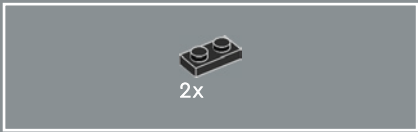

107

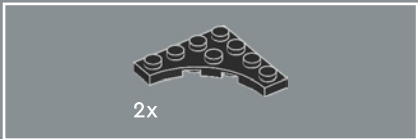
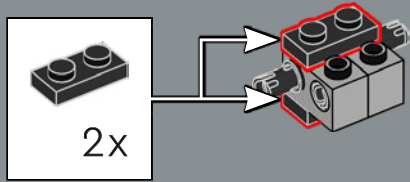

108

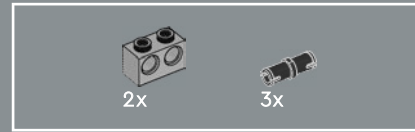
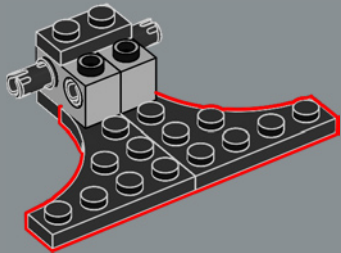

109

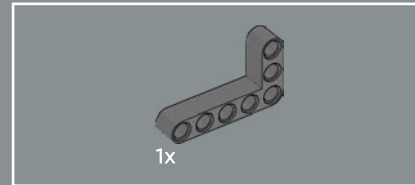
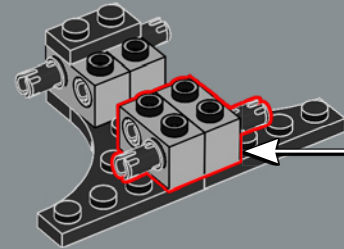
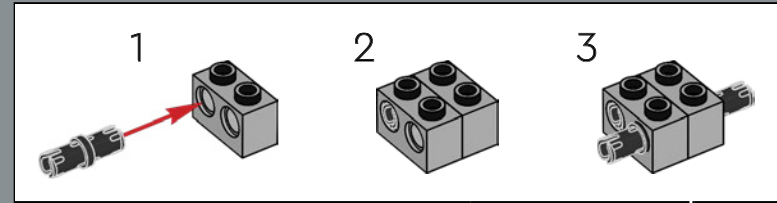

110

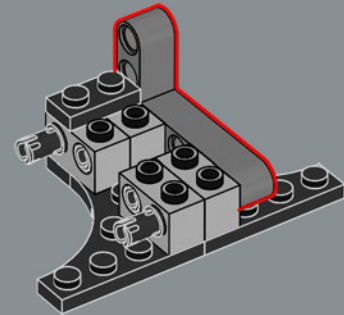

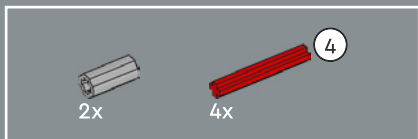

111

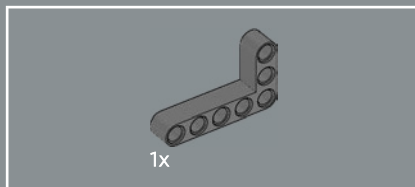
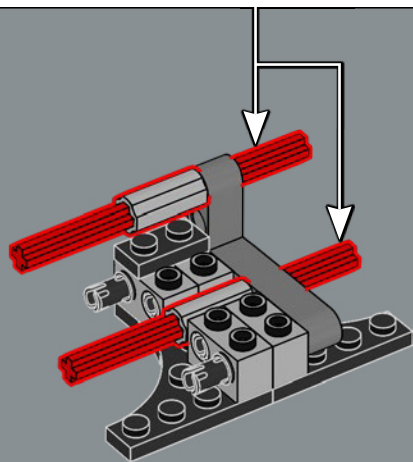
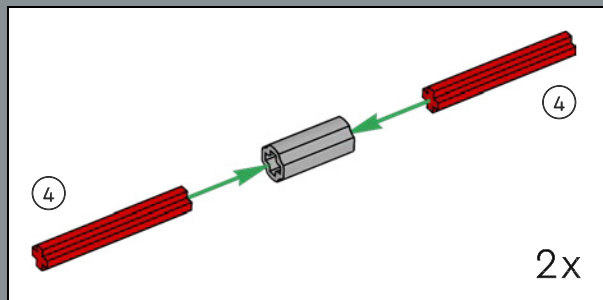

112

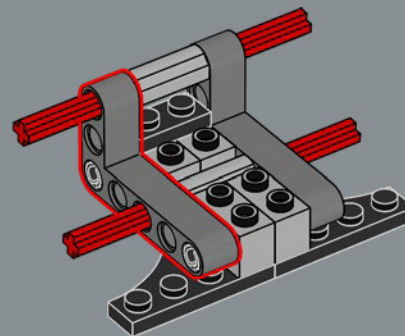

113

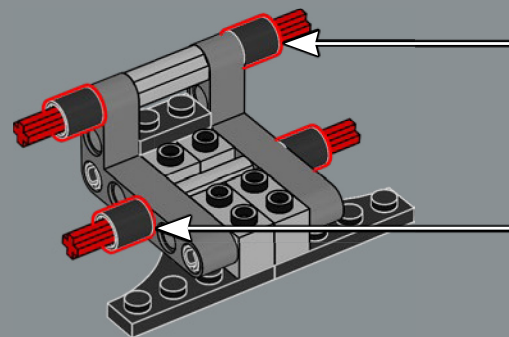



114

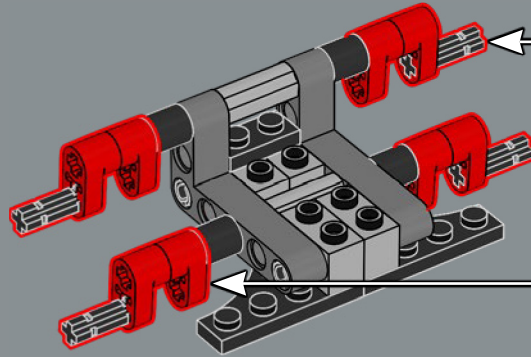
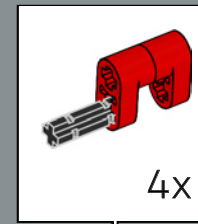

115

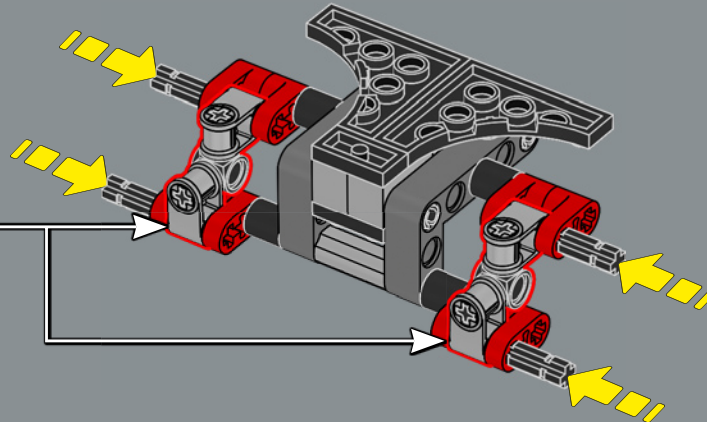
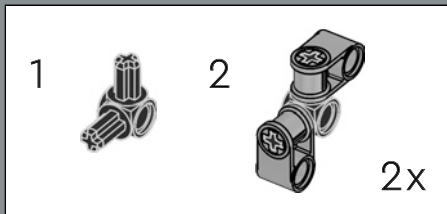

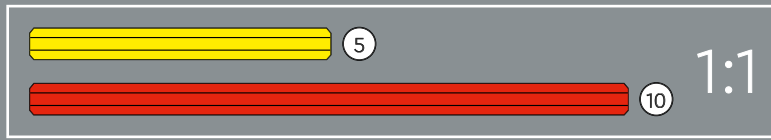
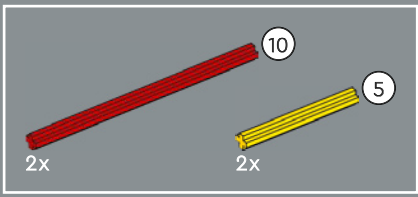

116

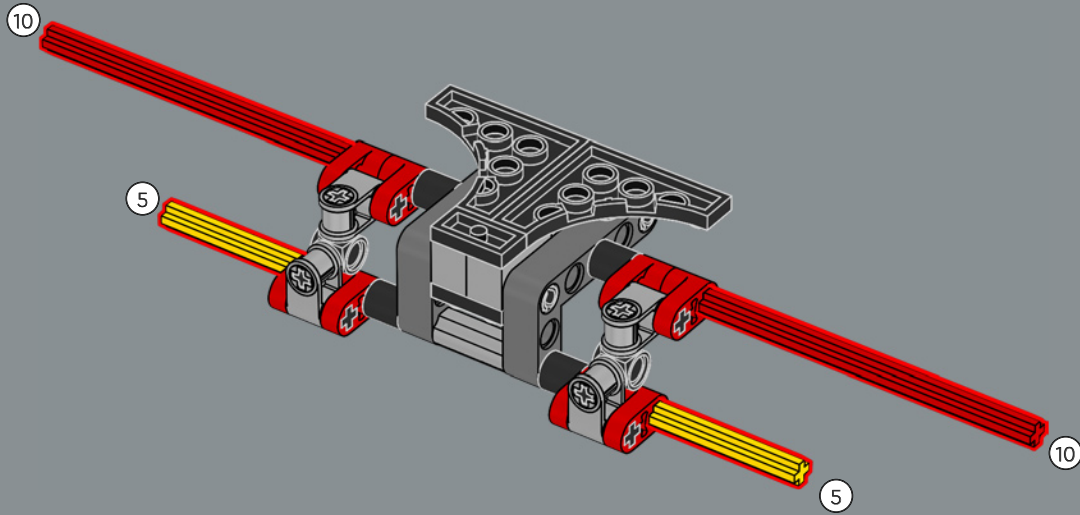

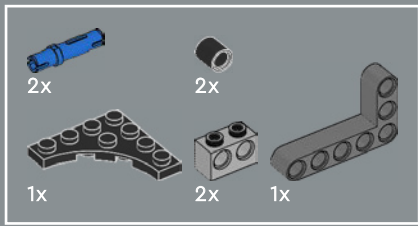

117

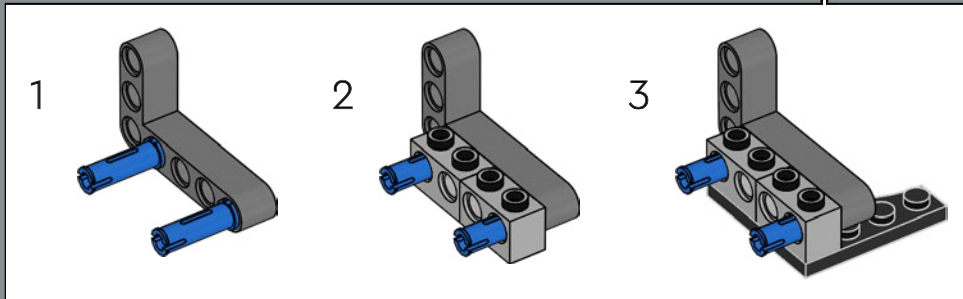
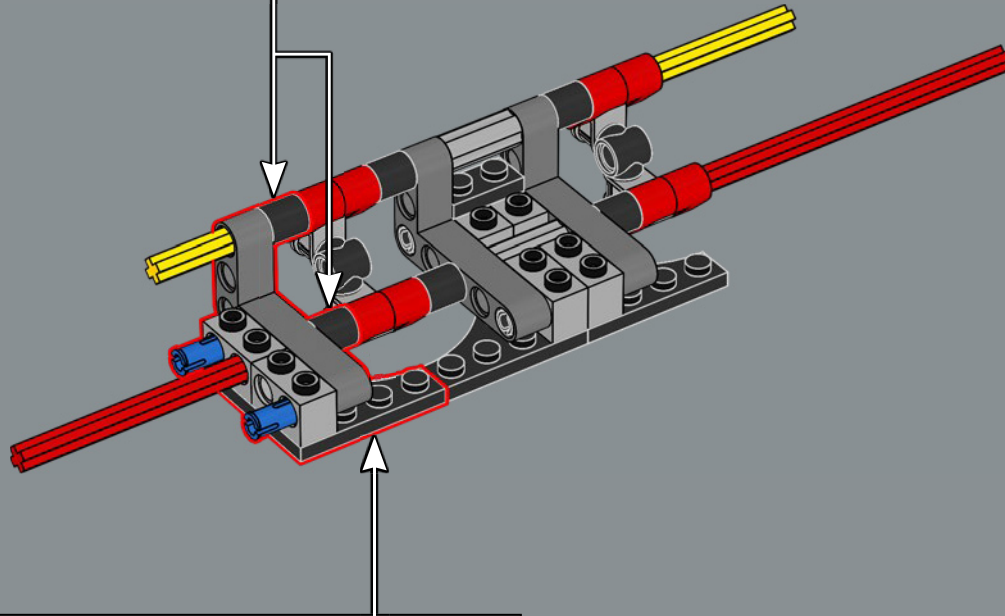

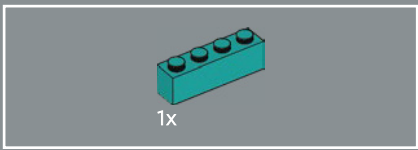

118

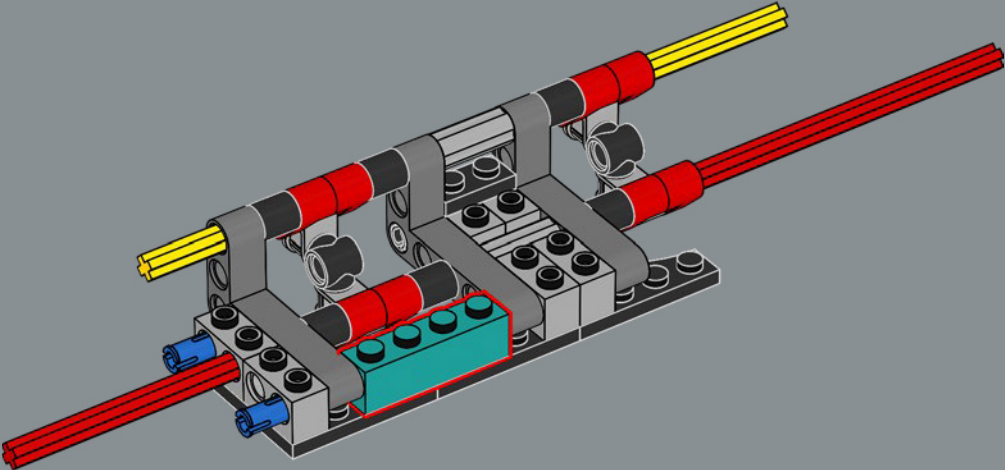

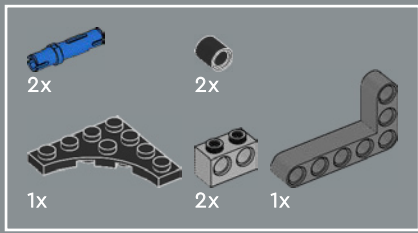

119

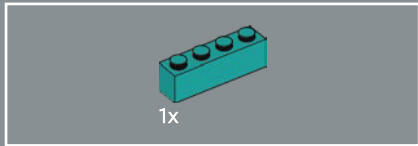
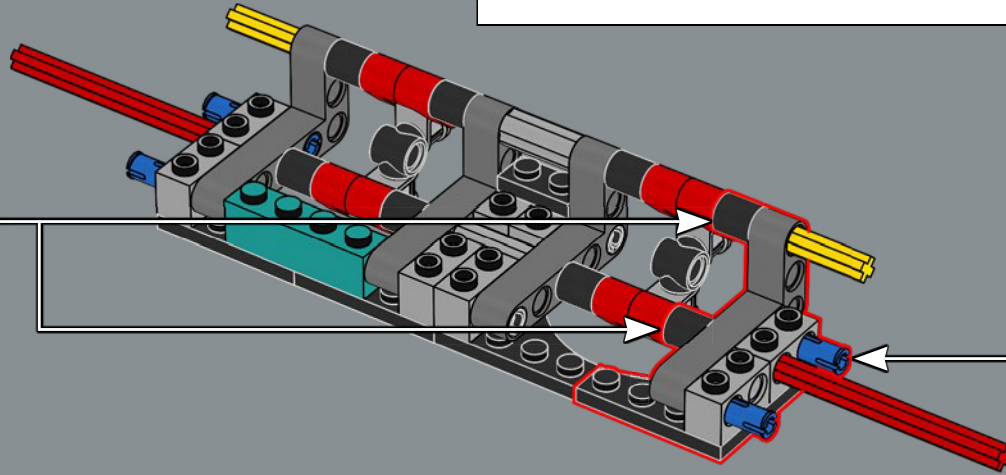
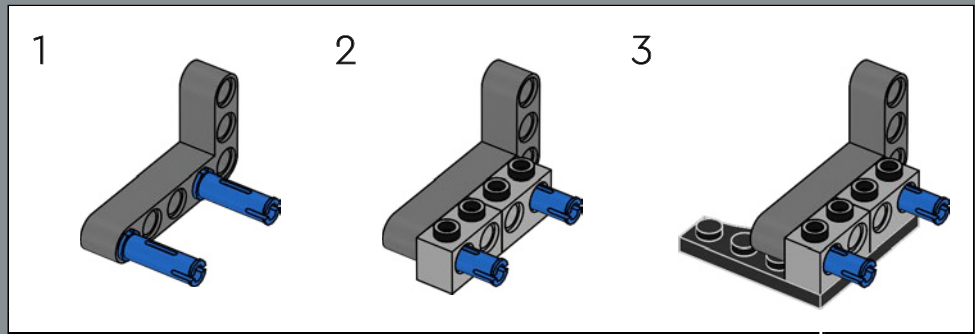

120

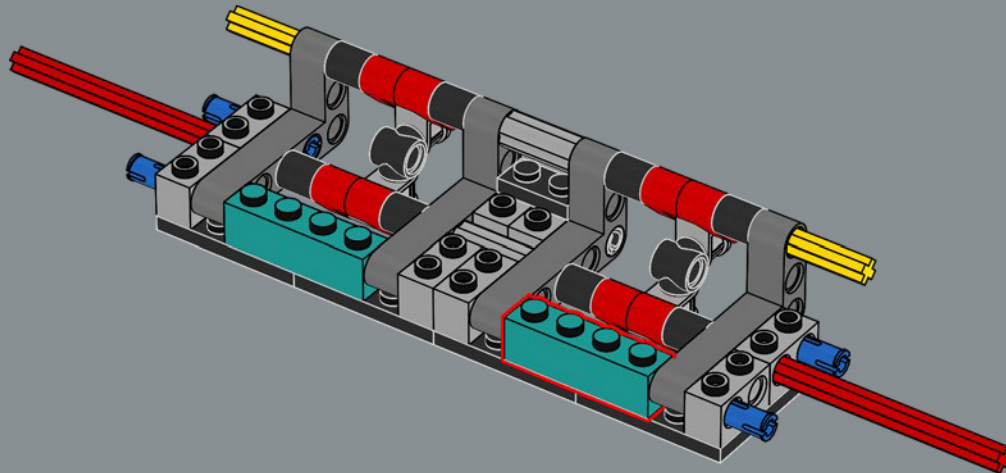

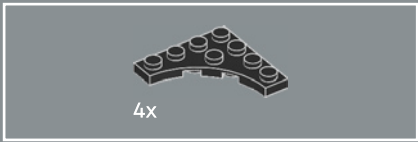

121

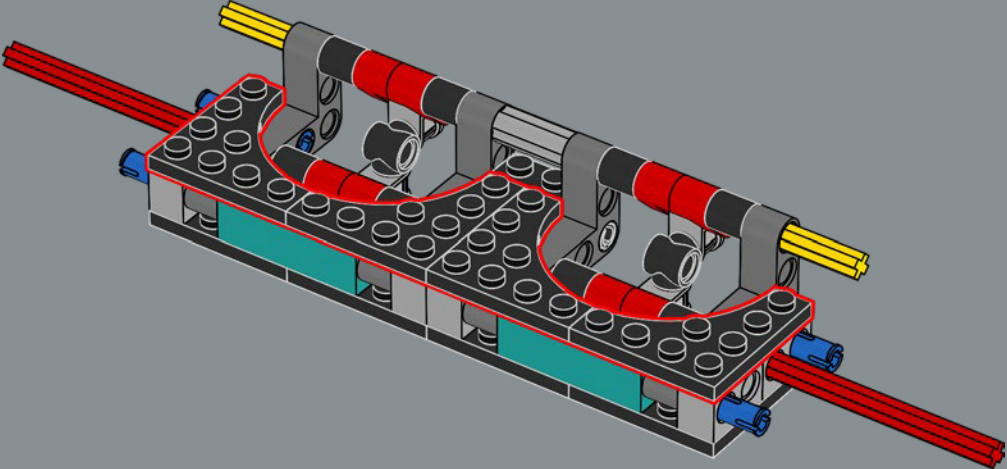

122

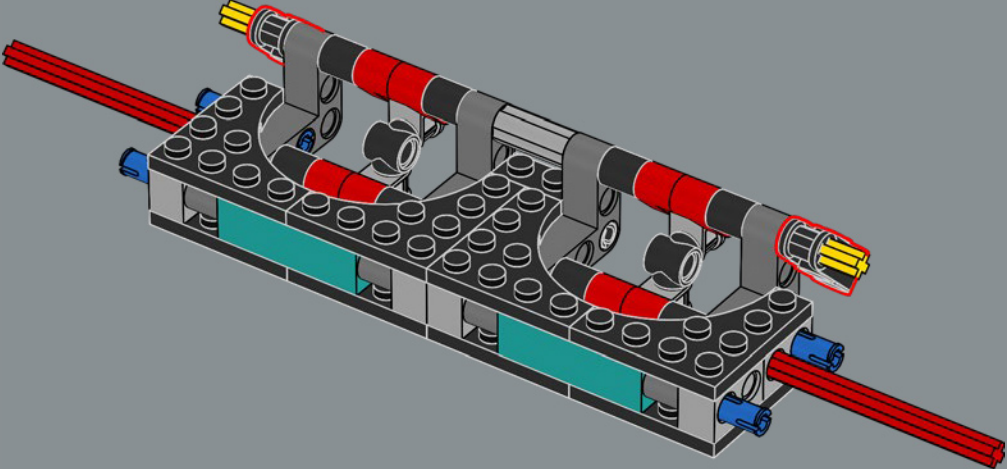

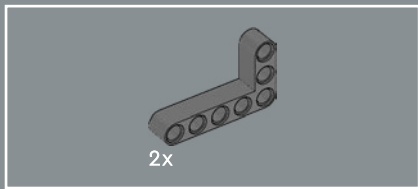

123

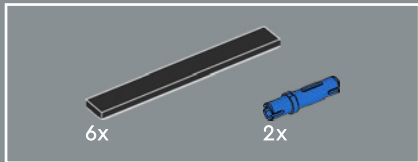
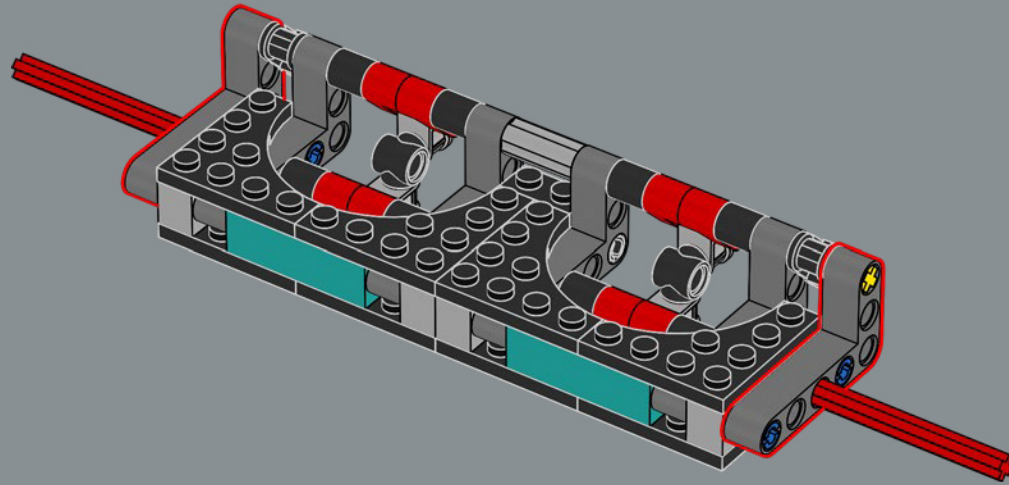

124

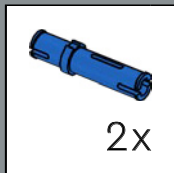
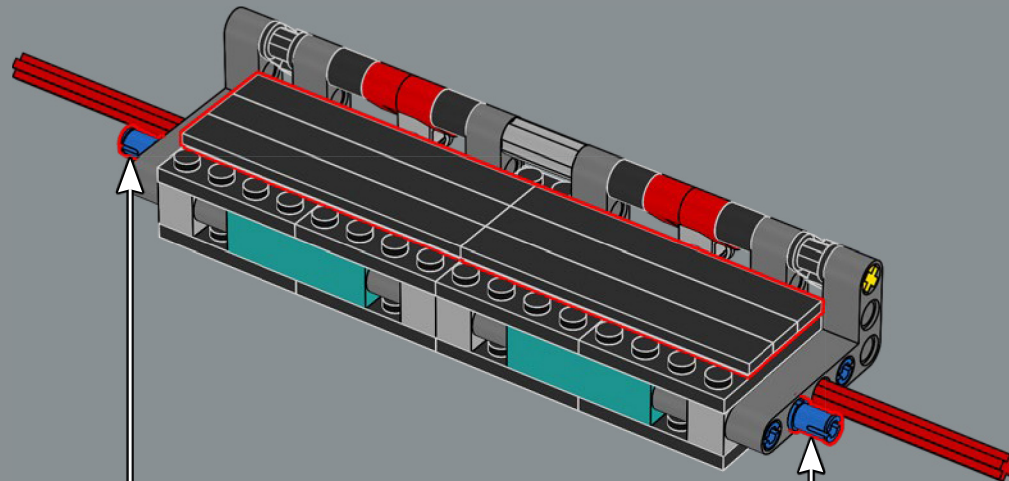

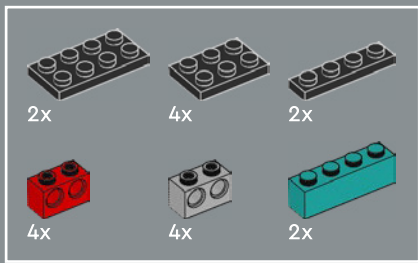

125

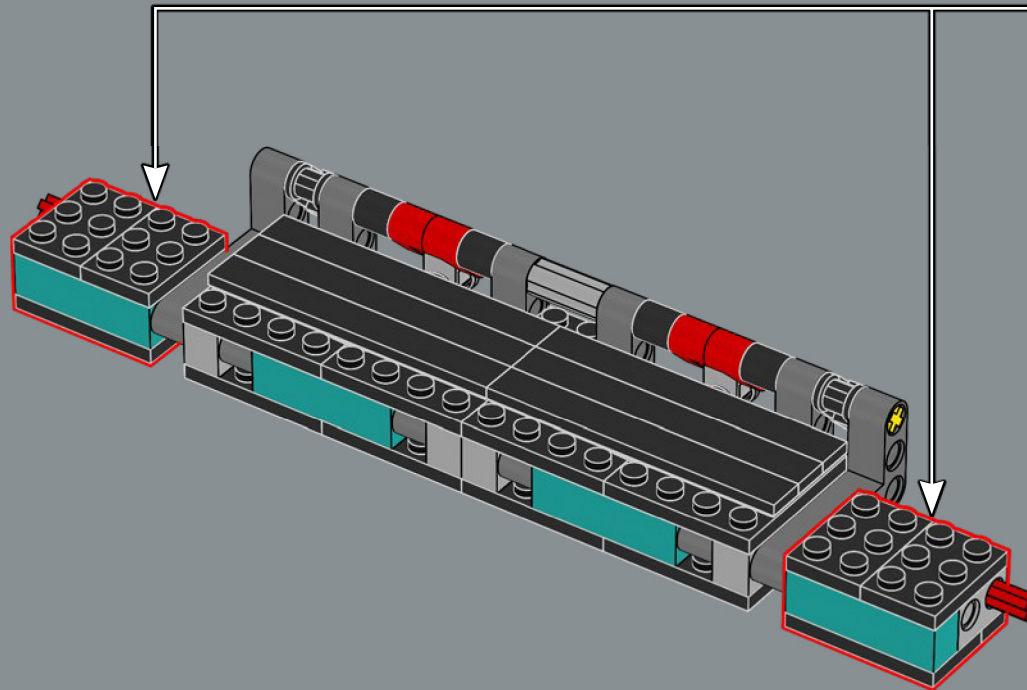
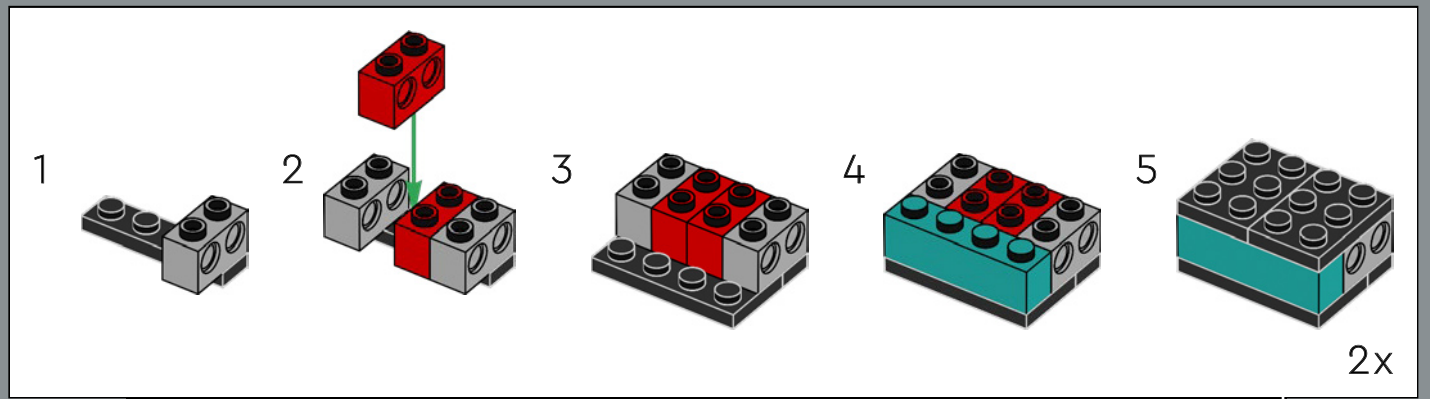



126

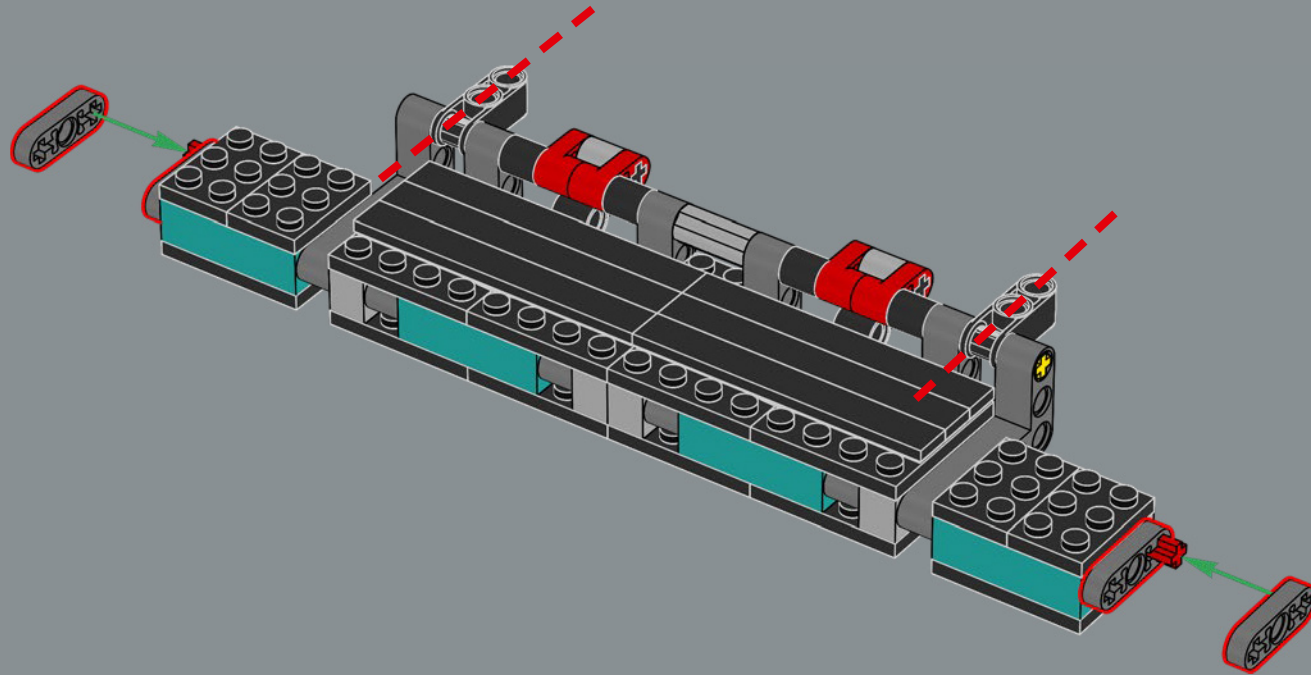

127

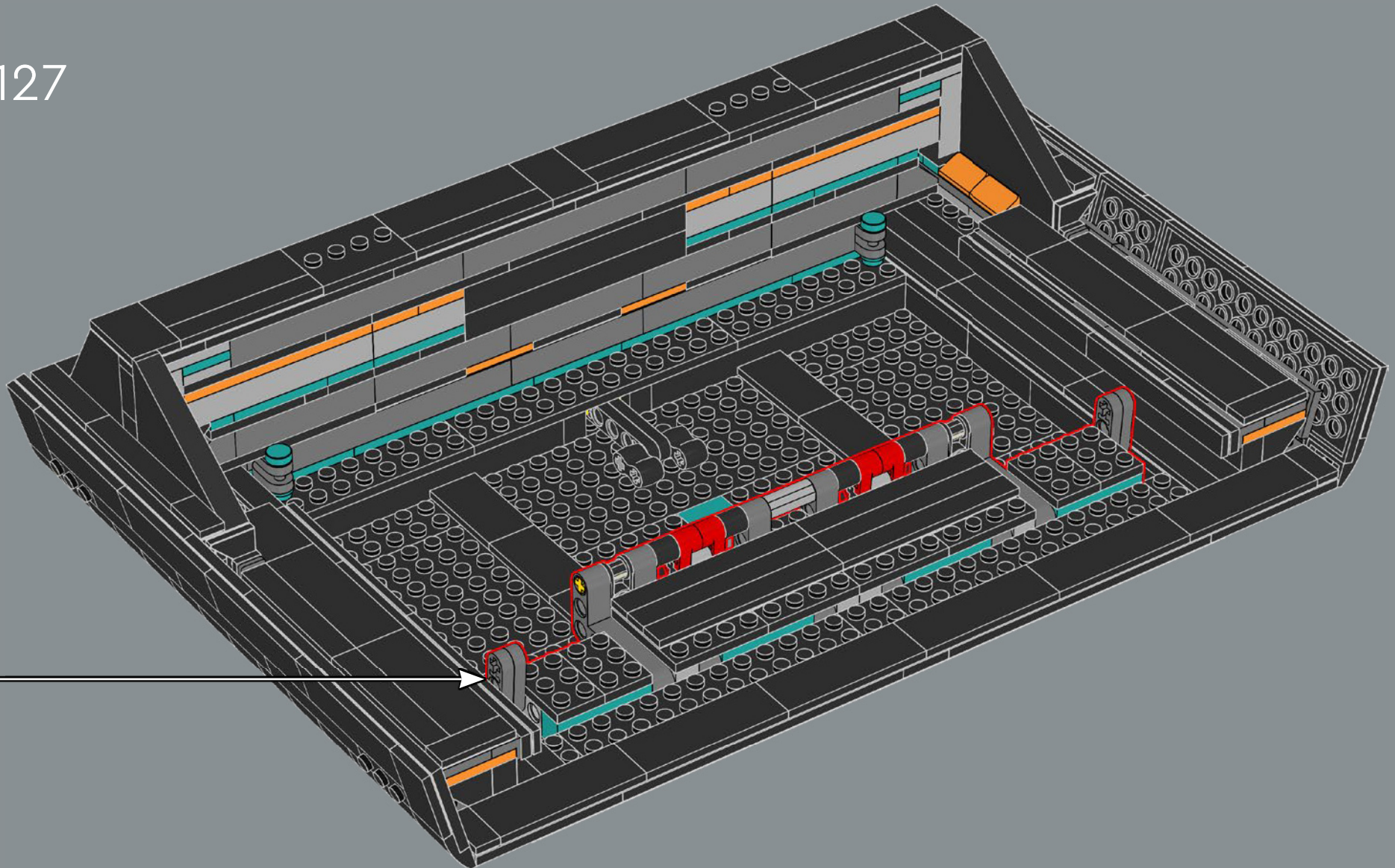

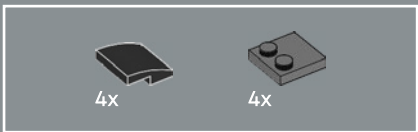

128

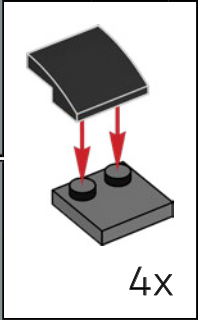
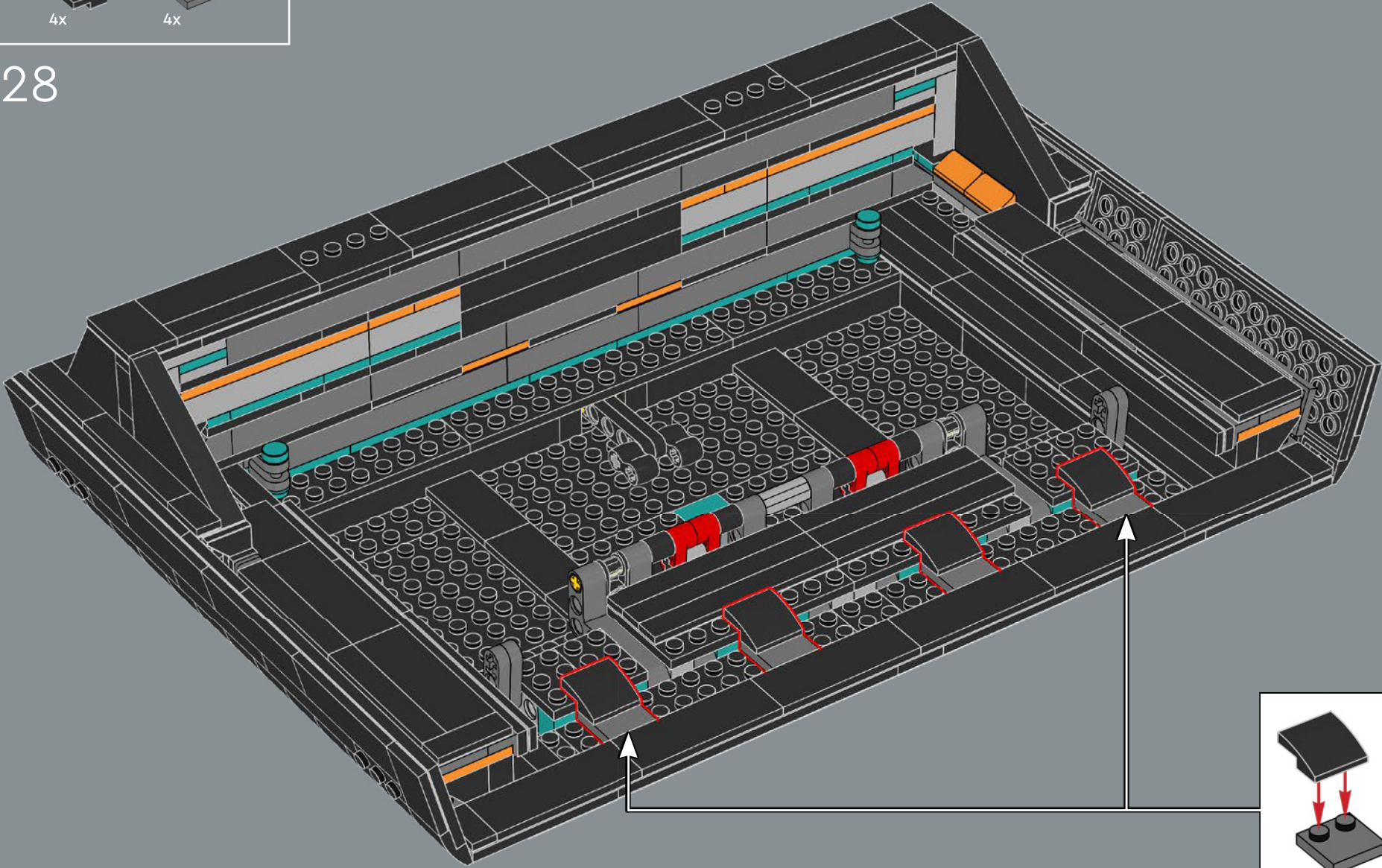



4x

129

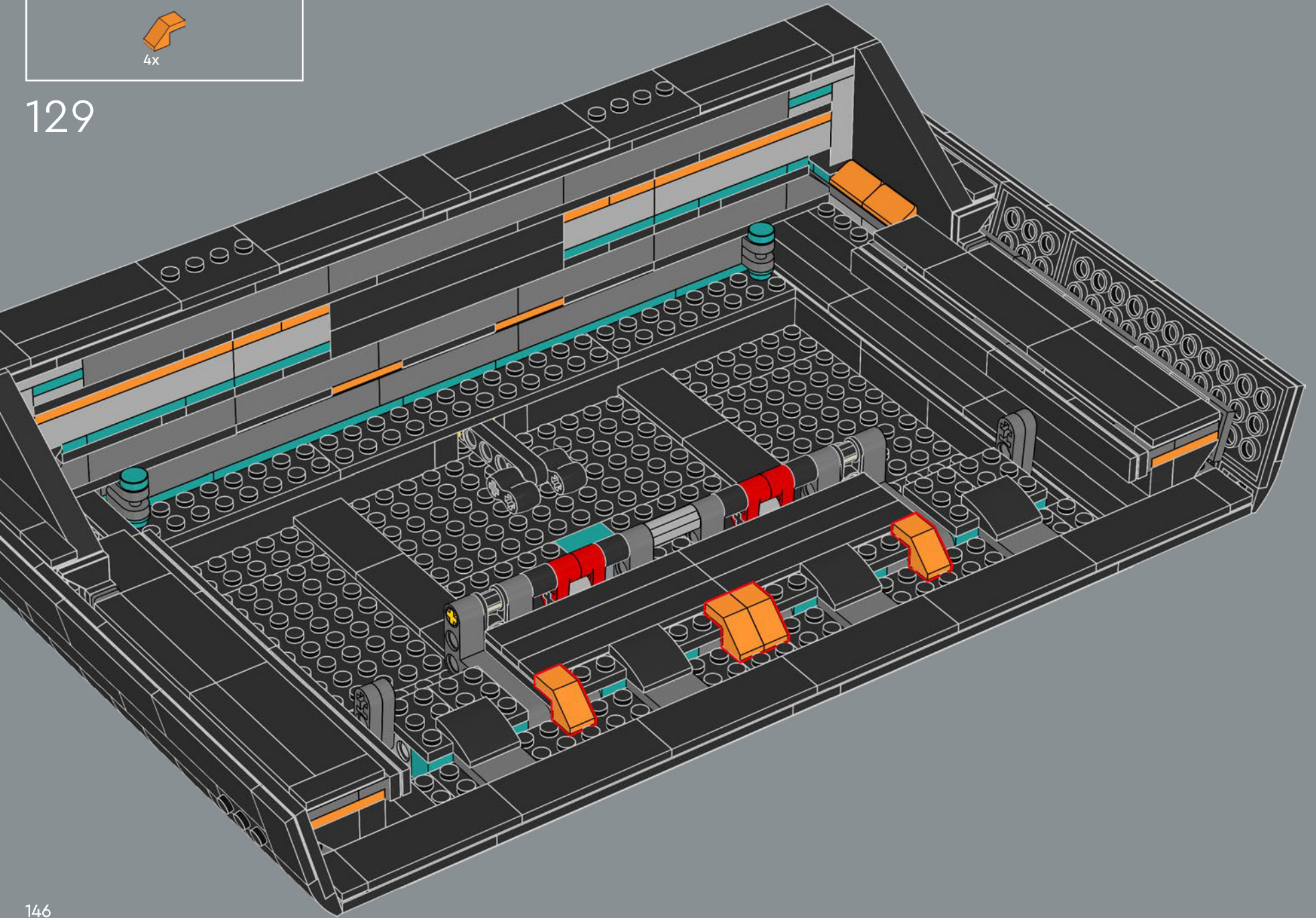

146

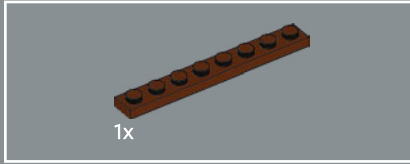
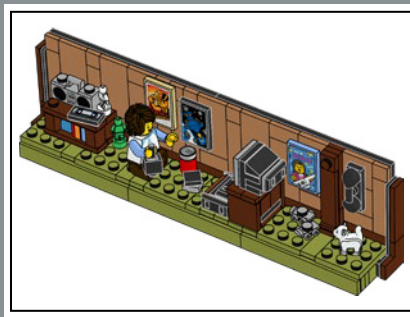

130

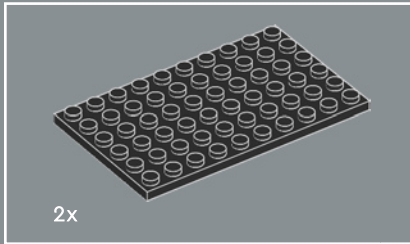
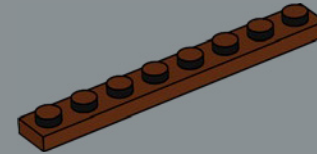

131

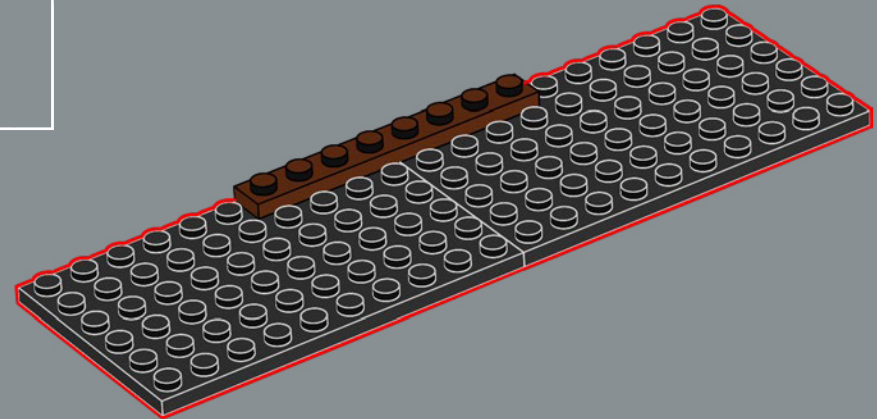

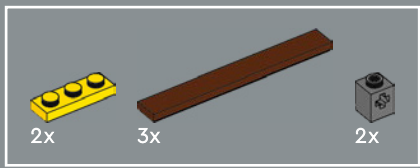

132

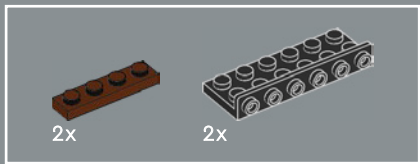
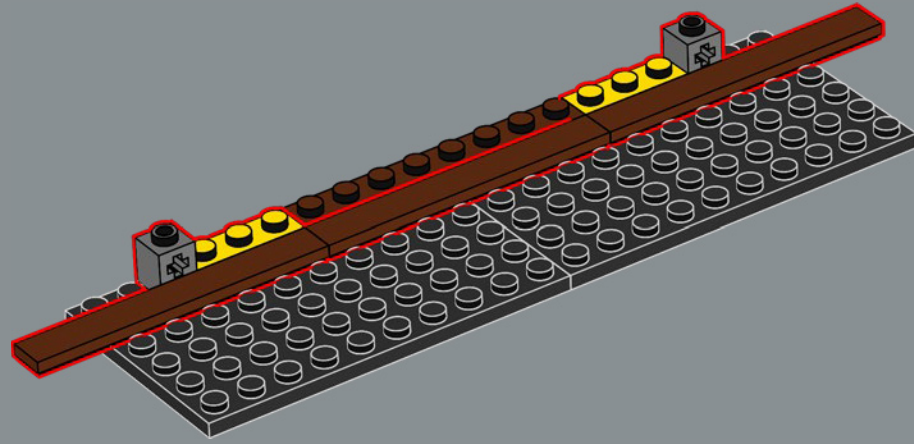

133

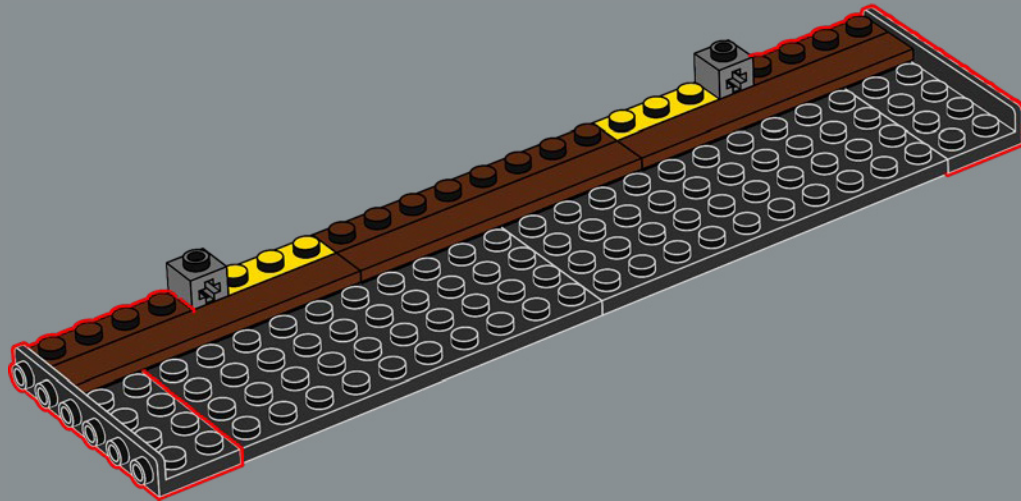

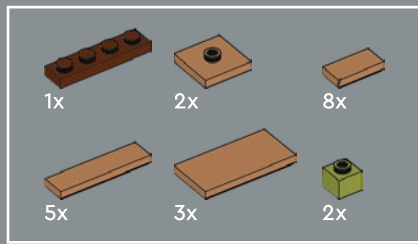

134

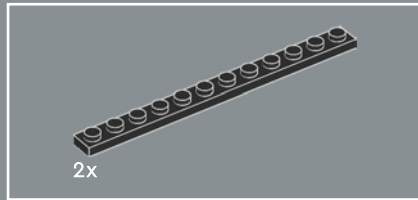
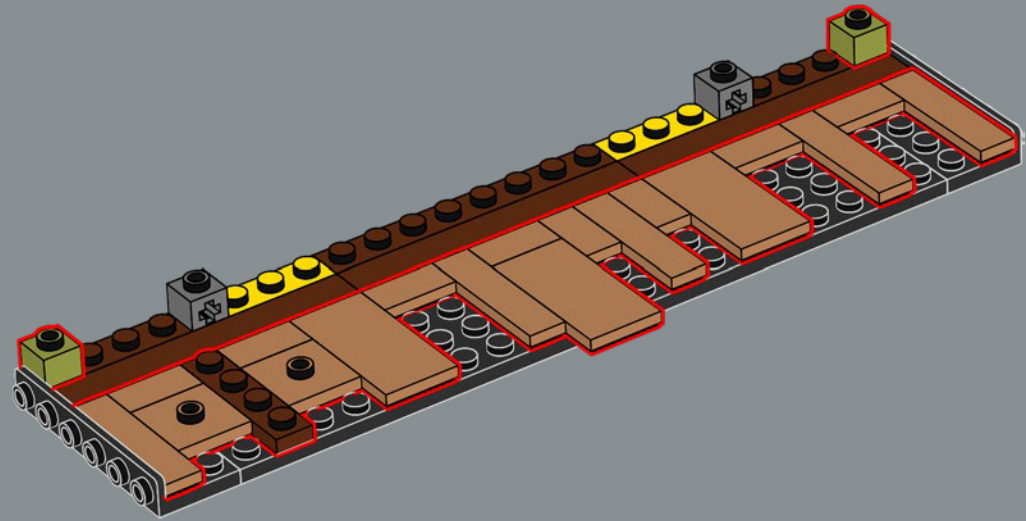

135

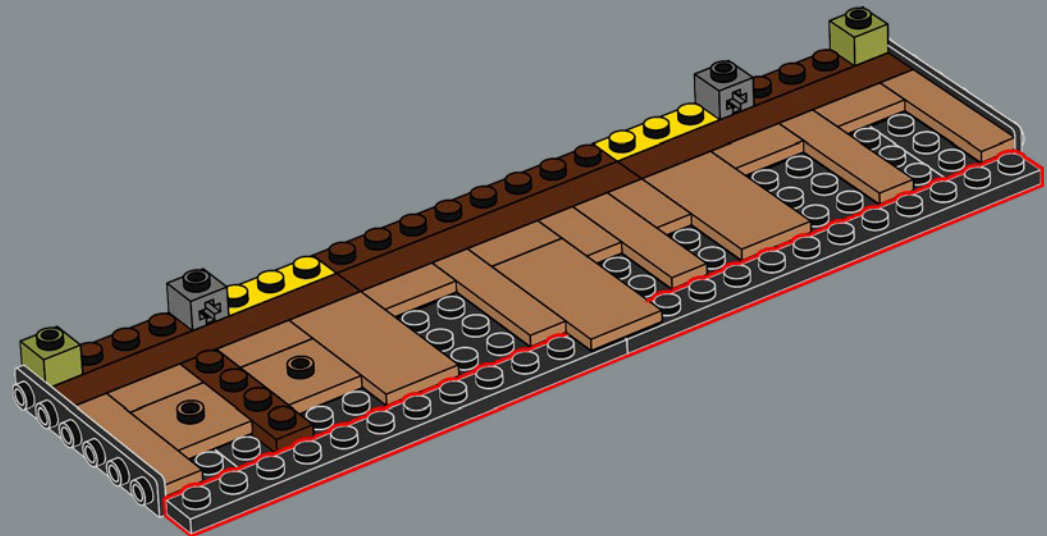

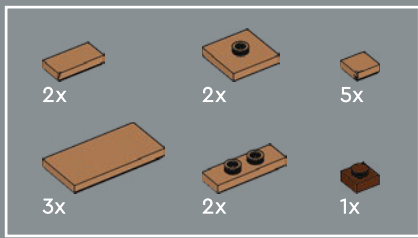

136

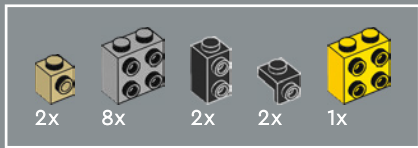
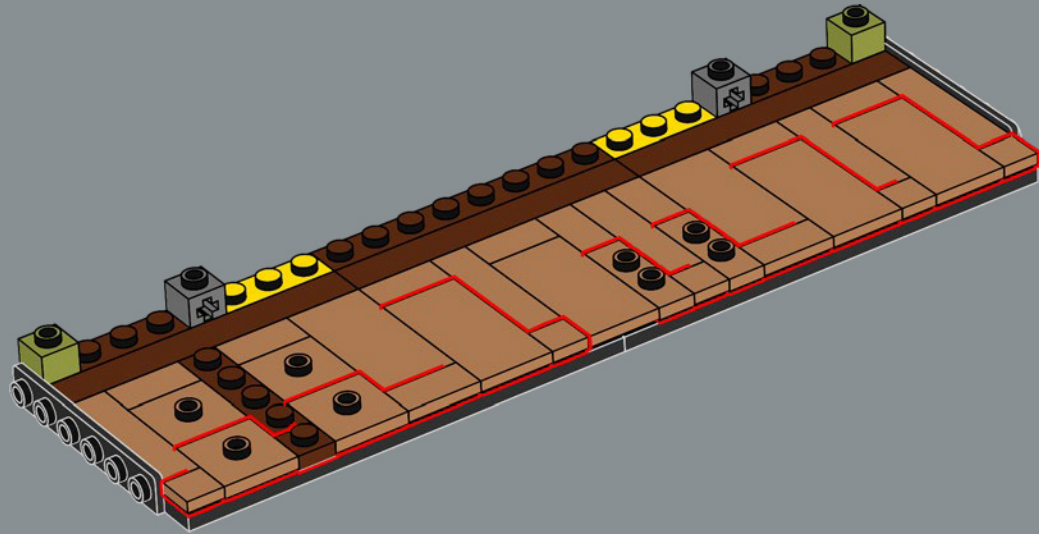

137

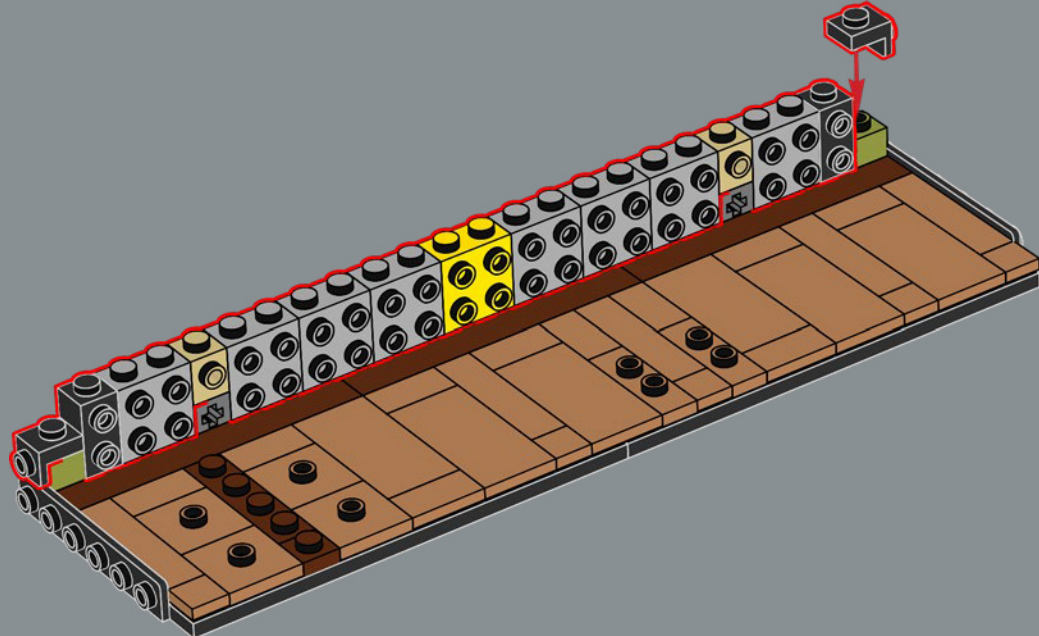

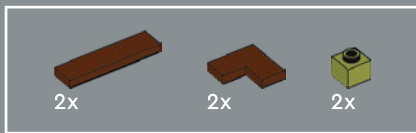

138

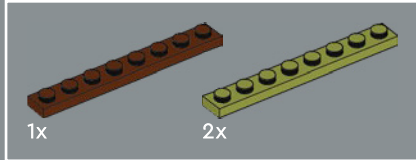
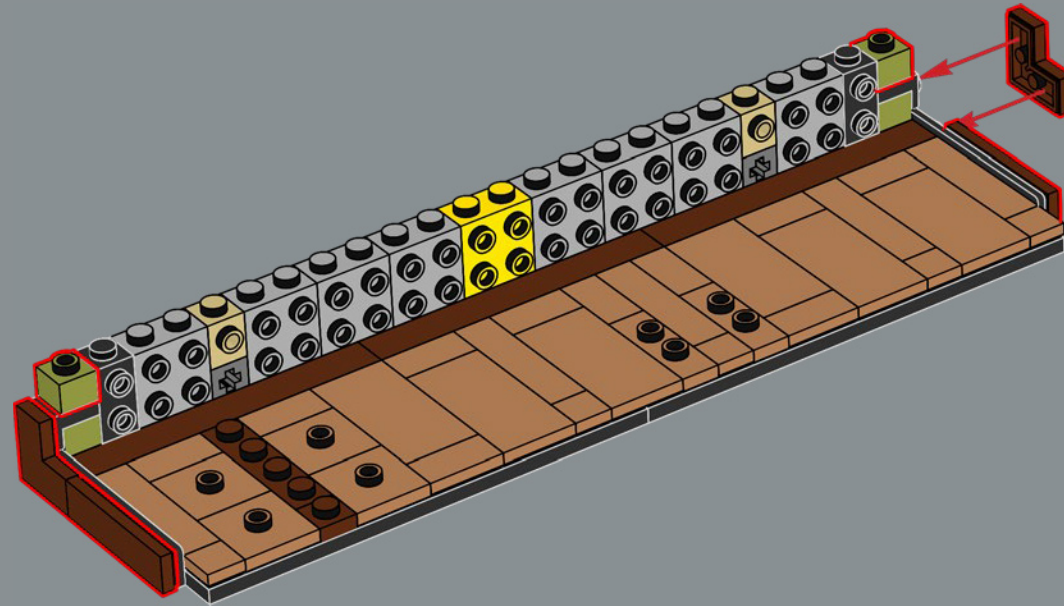

139

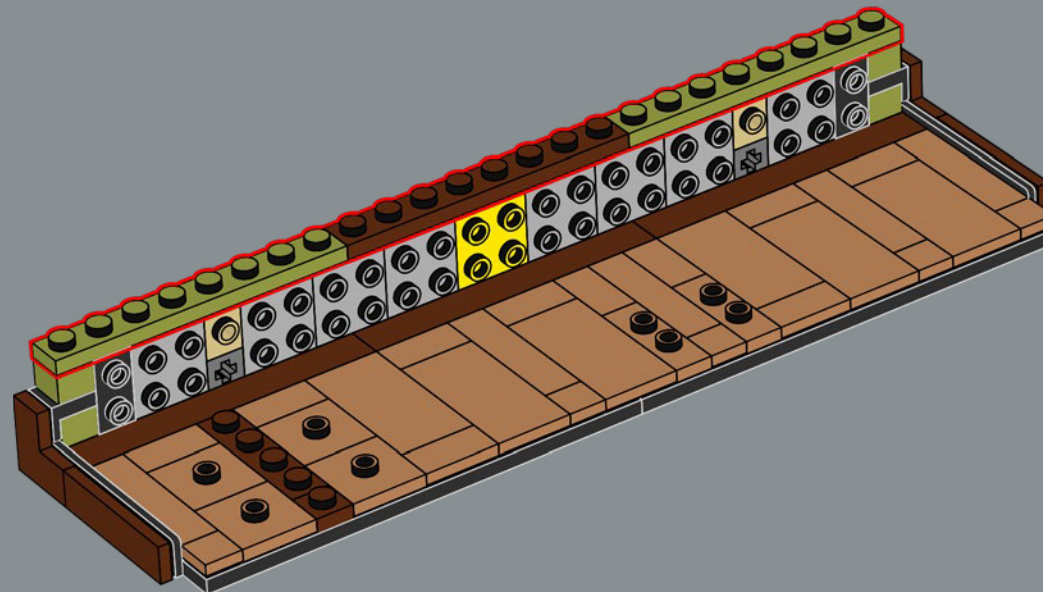

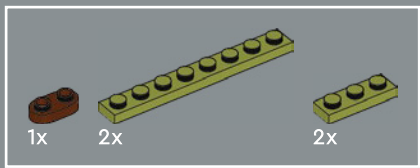

140

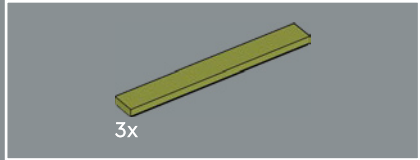
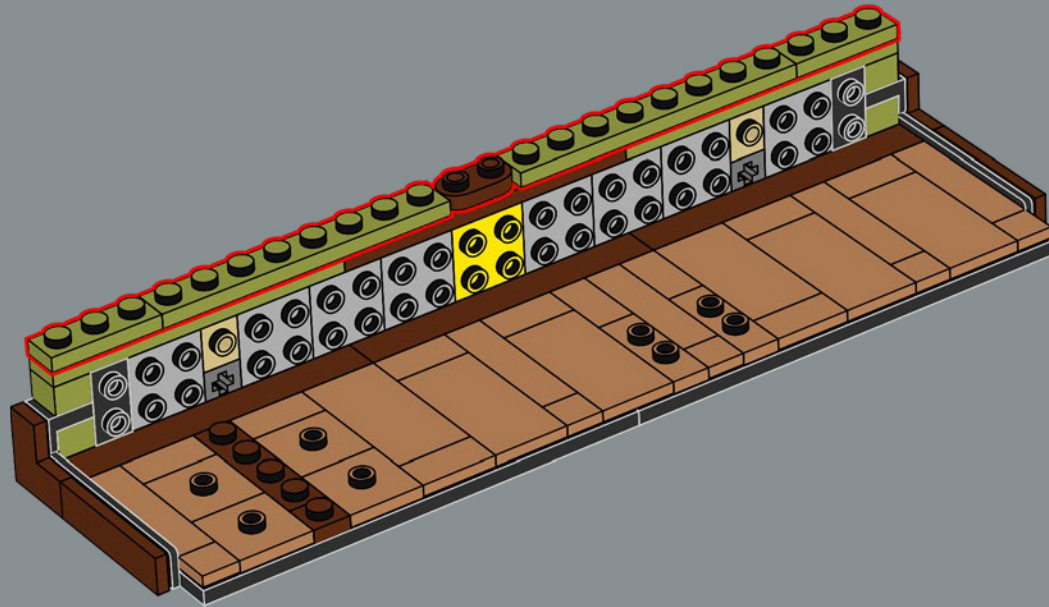

141

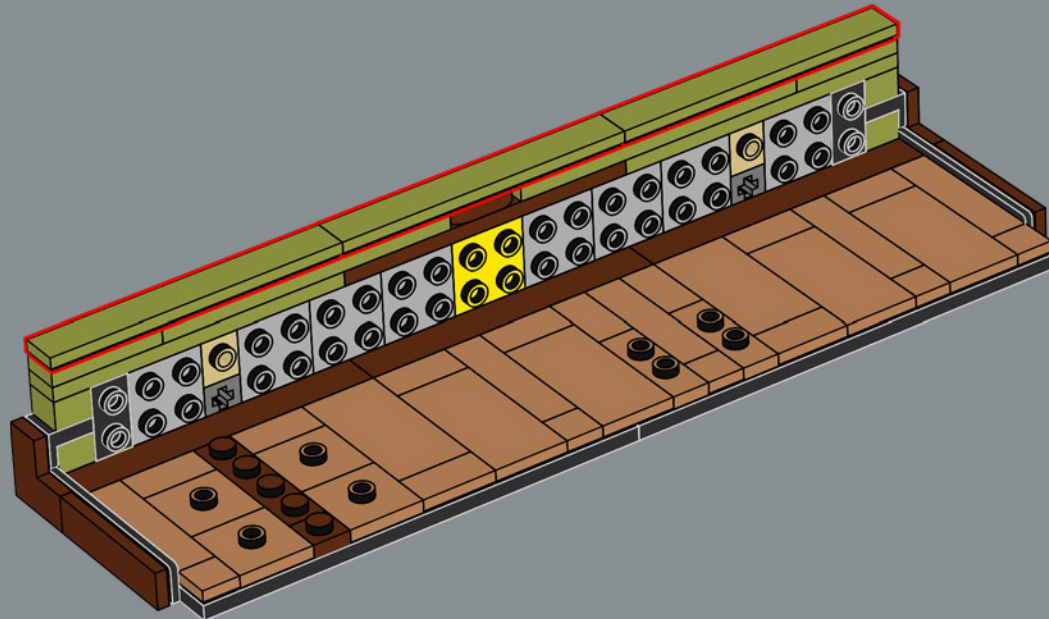

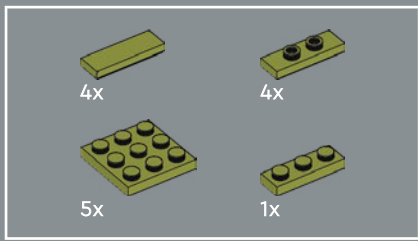

142

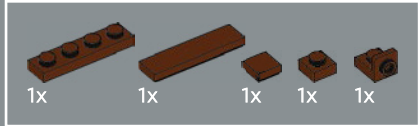
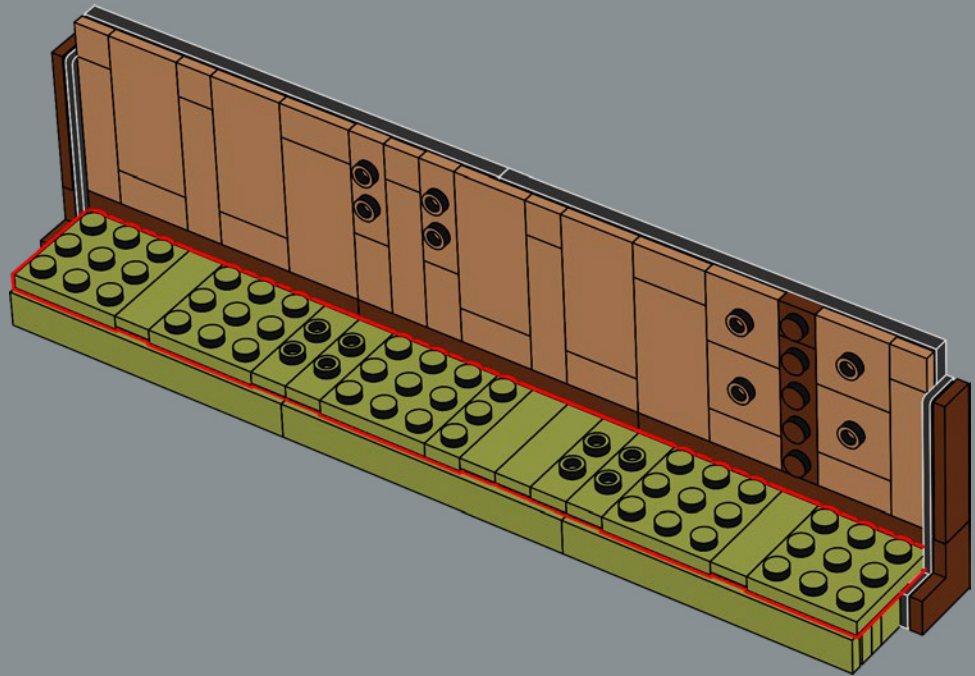

143

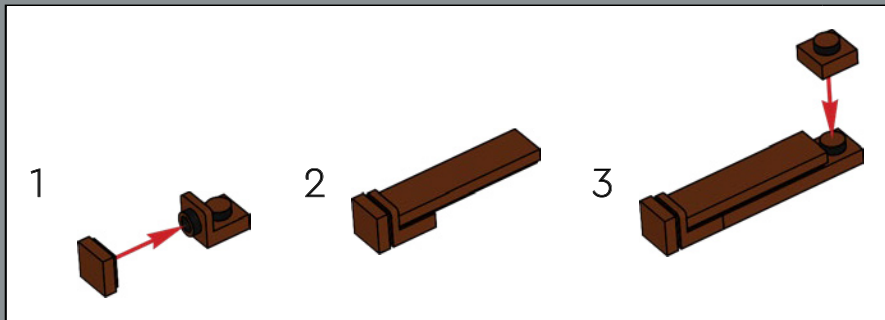
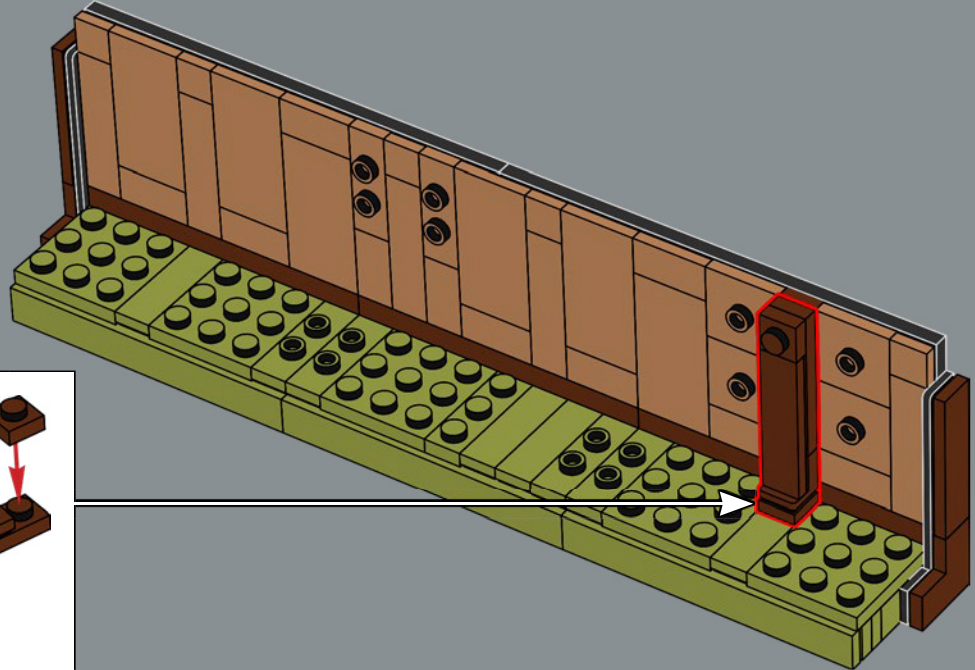

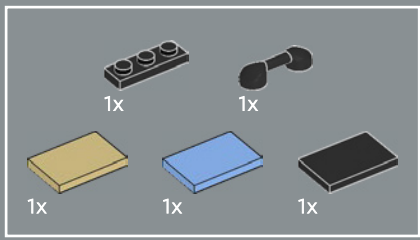

144

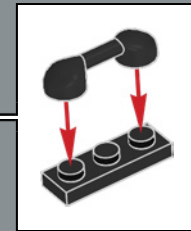
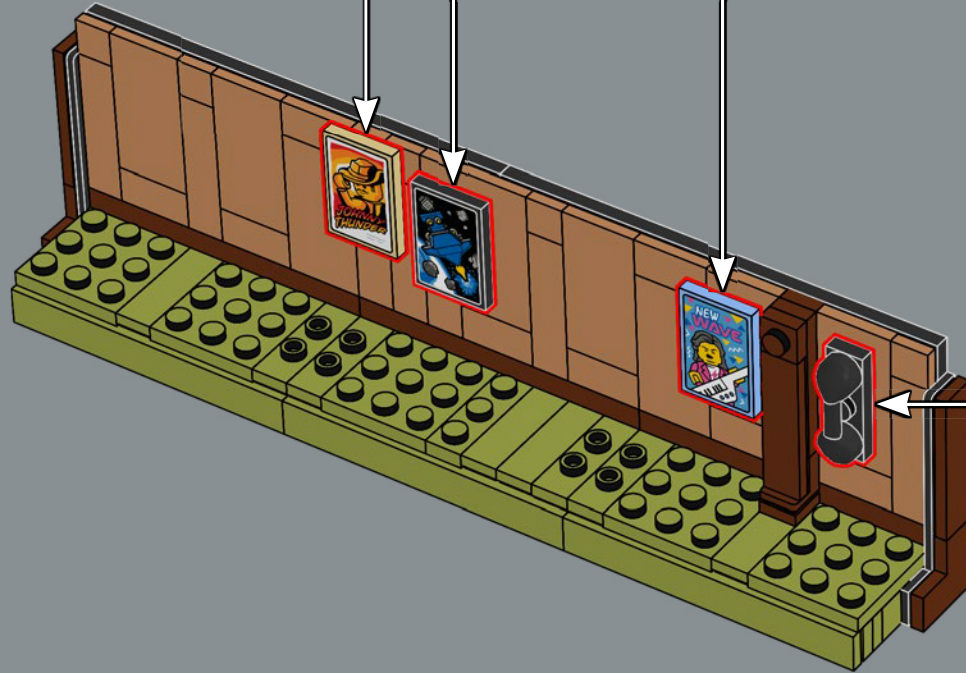
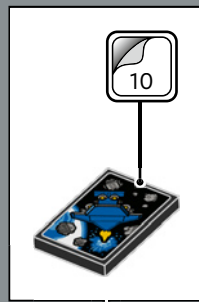

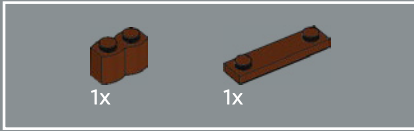

145

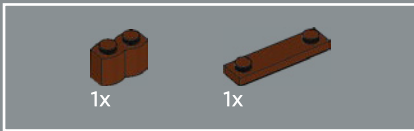
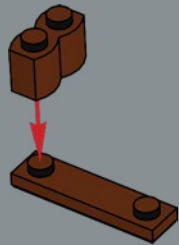

146

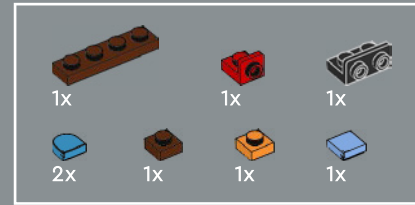
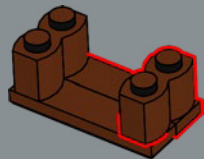

147

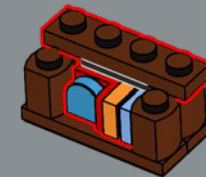
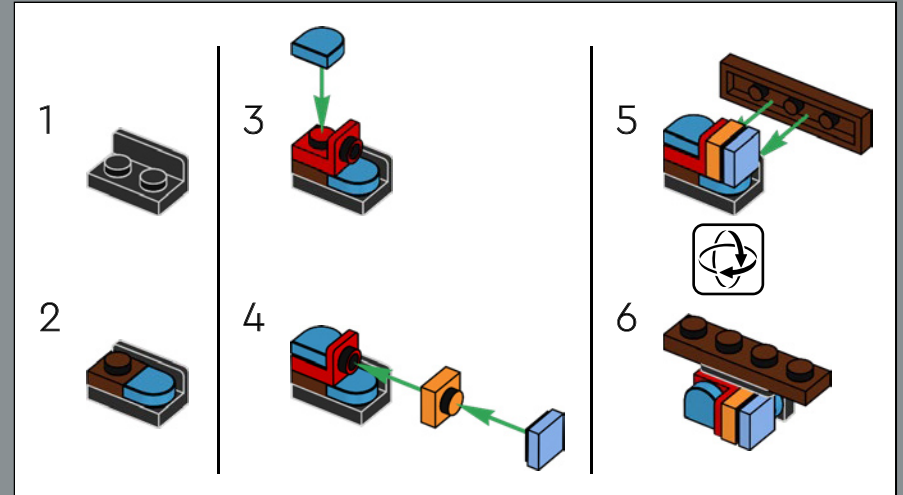

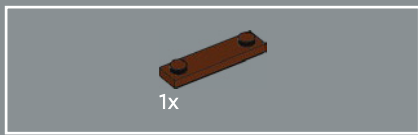

148

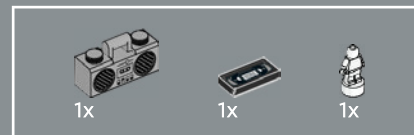
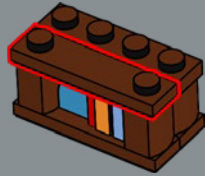

149



150

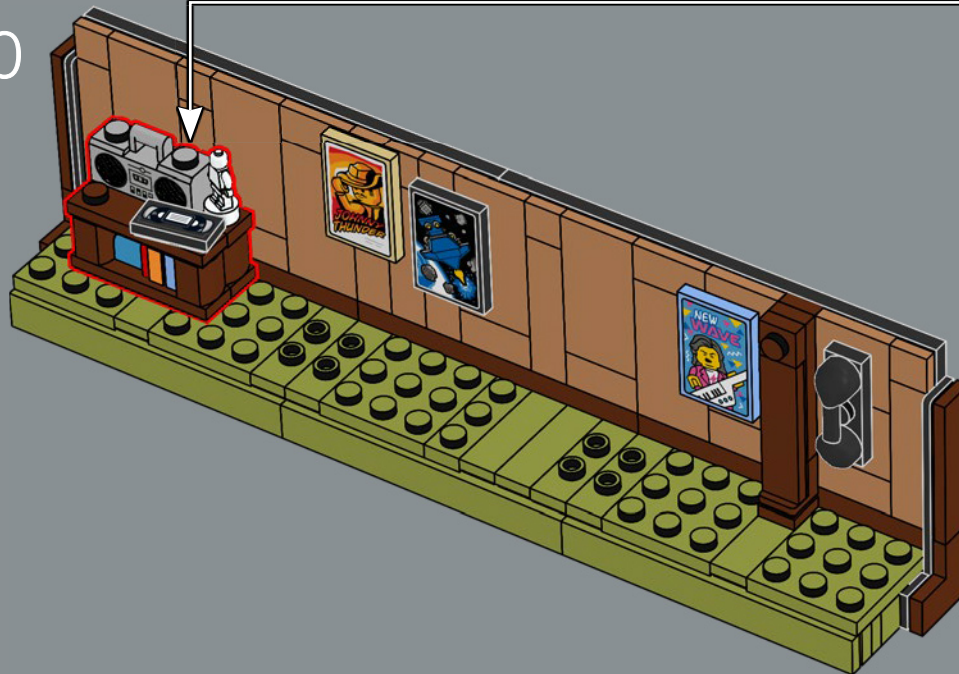

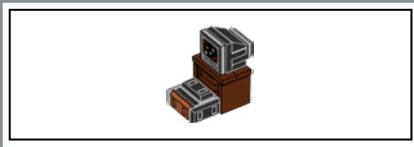

151

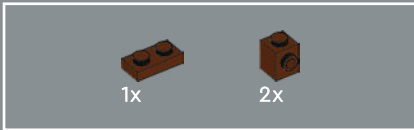
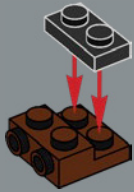

152

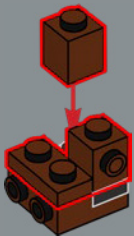

153

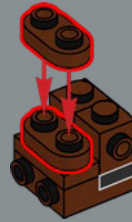

154

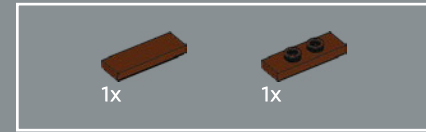
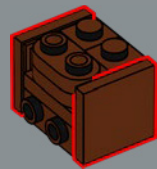

155

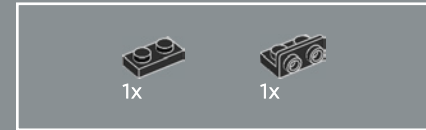
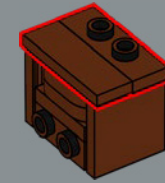

156

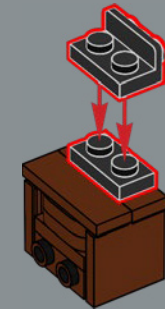



1x

157

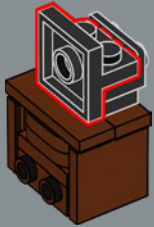

159

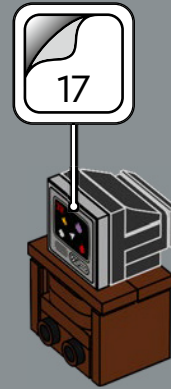

1x



1x



1x

158

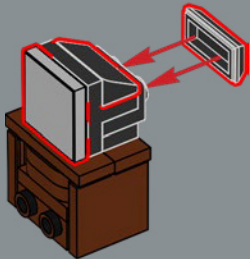

1x



3x



2x



1x

160

1

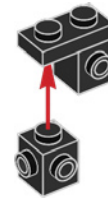

2



3

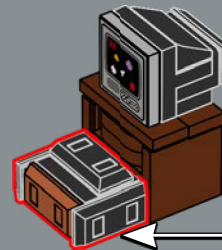

161

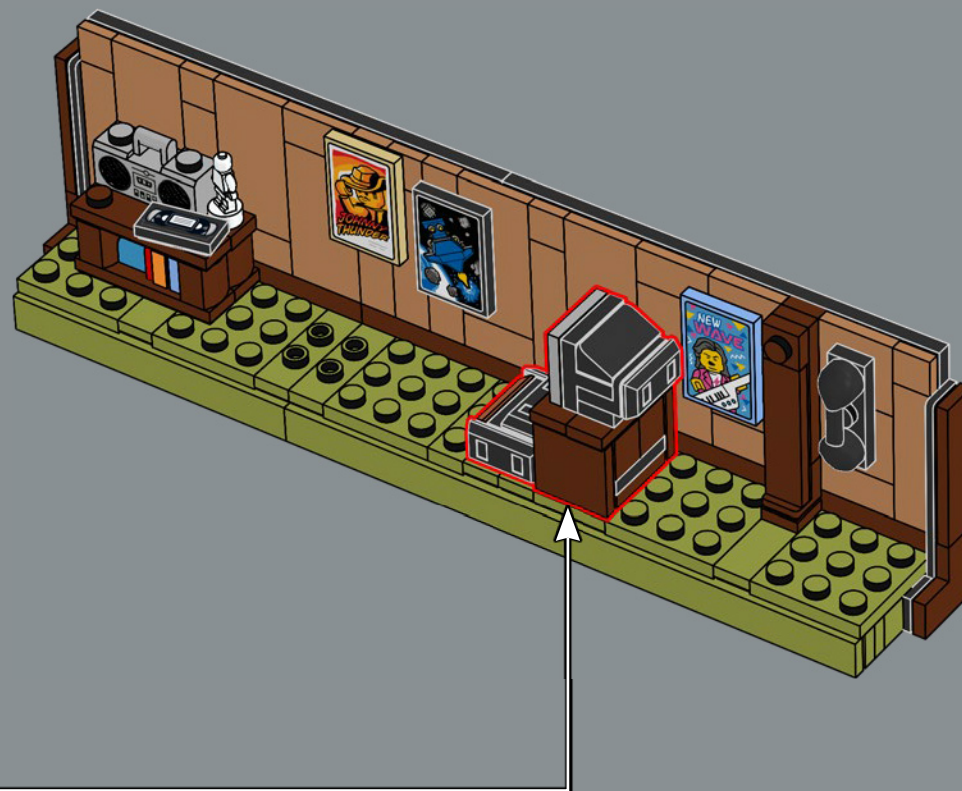



162

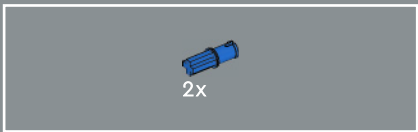

163

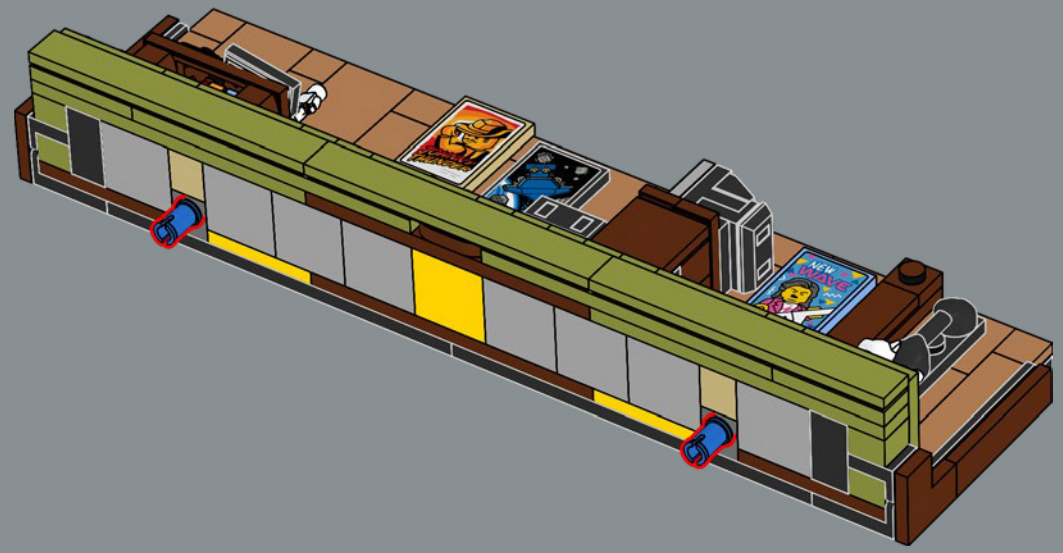

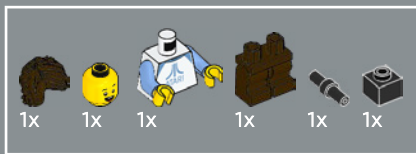

164

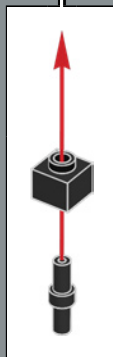
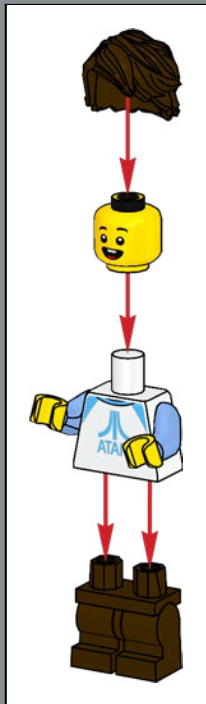

165

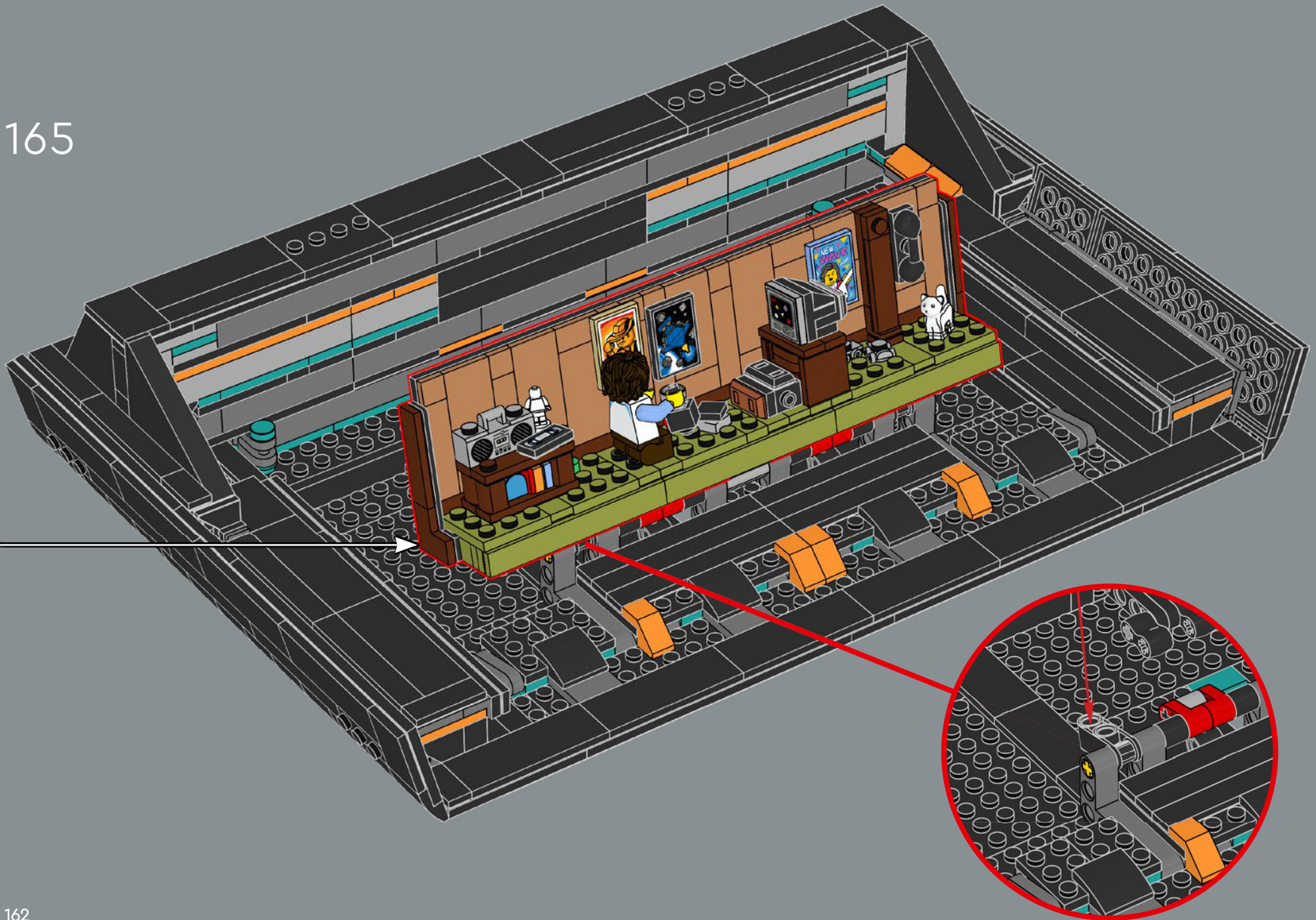

162

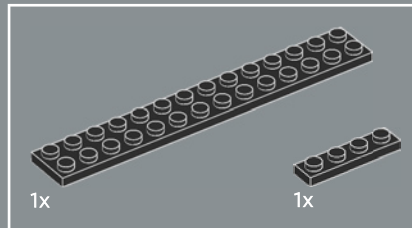
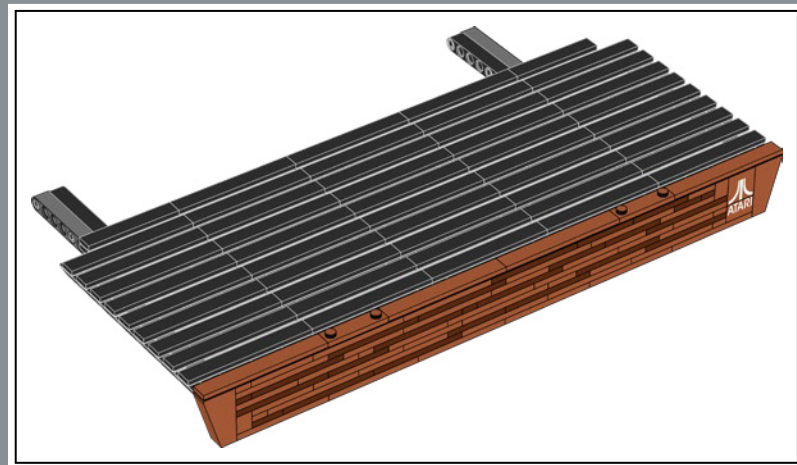
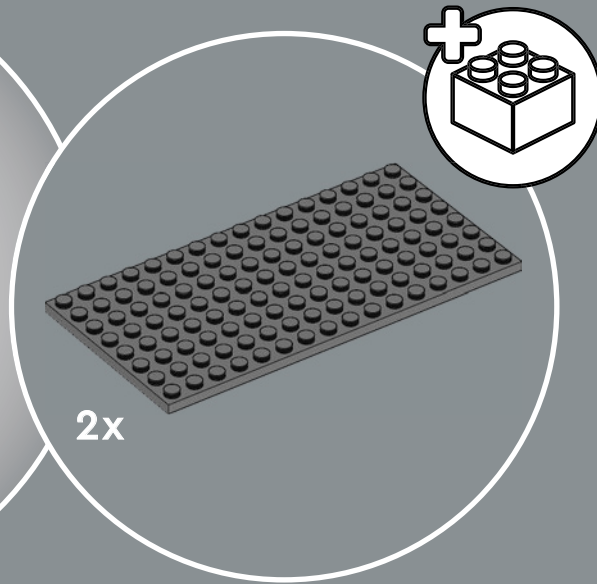

166

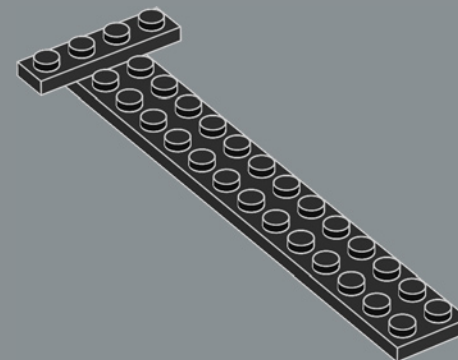

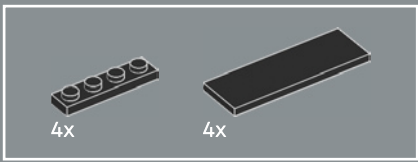

167

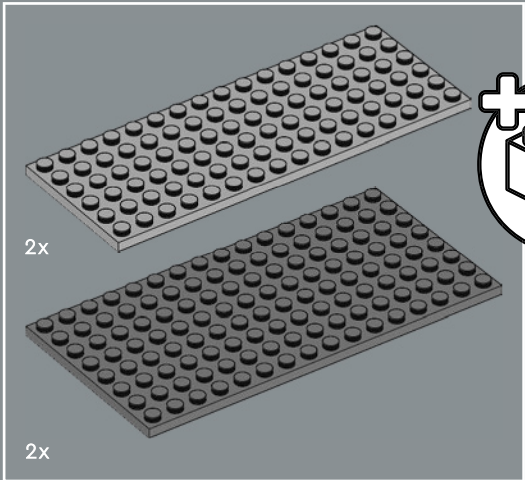
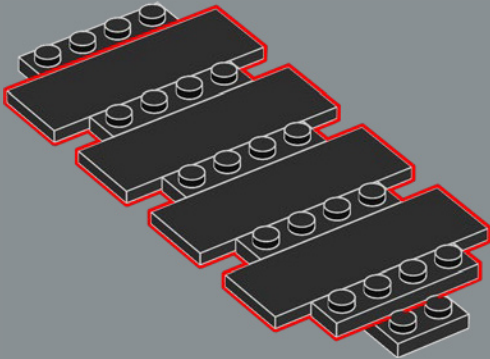

168

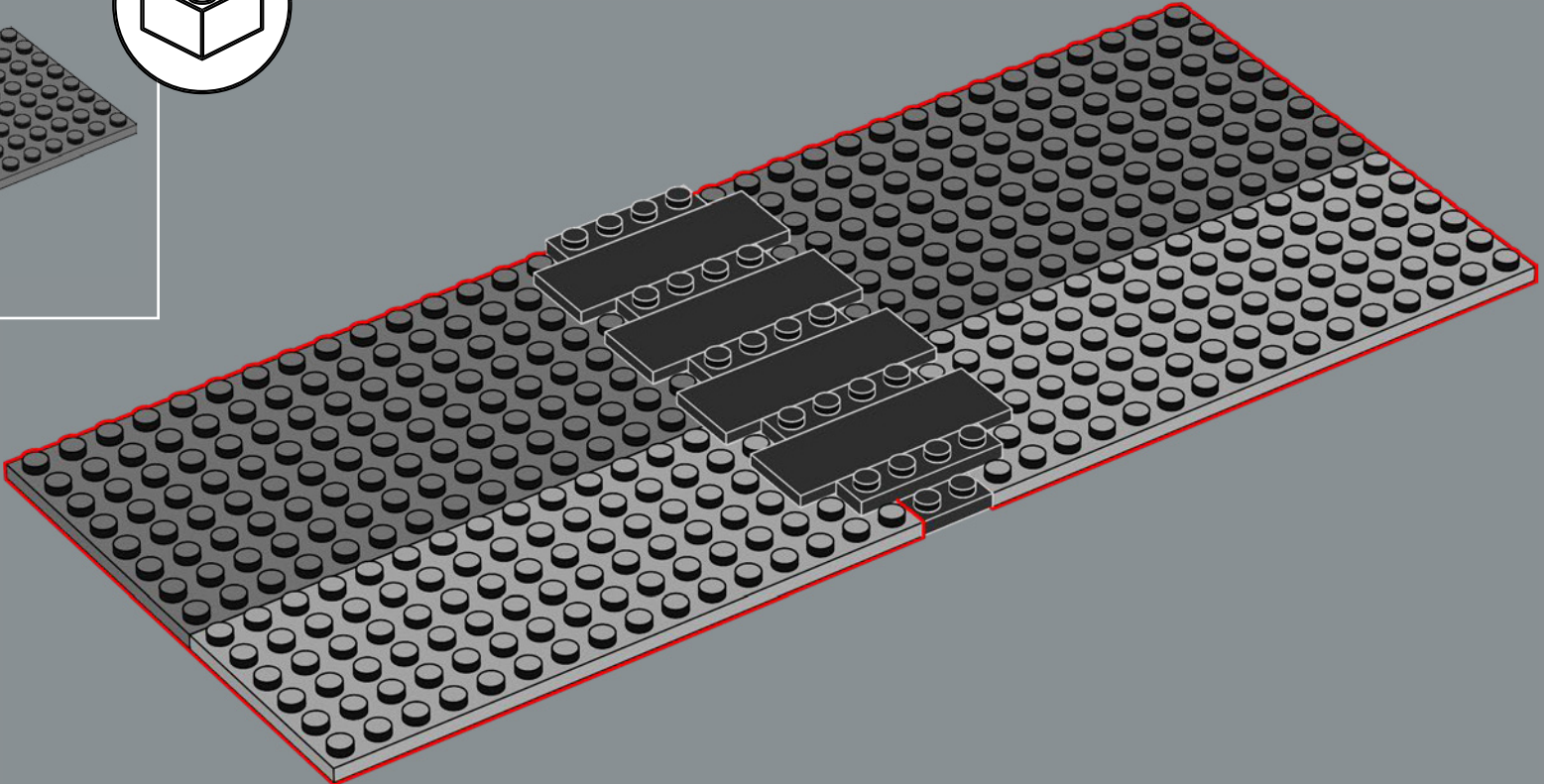

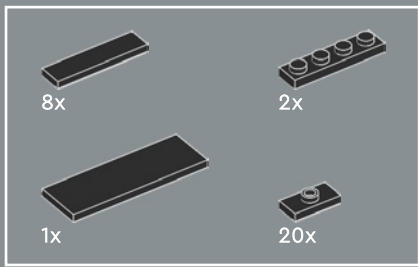

169

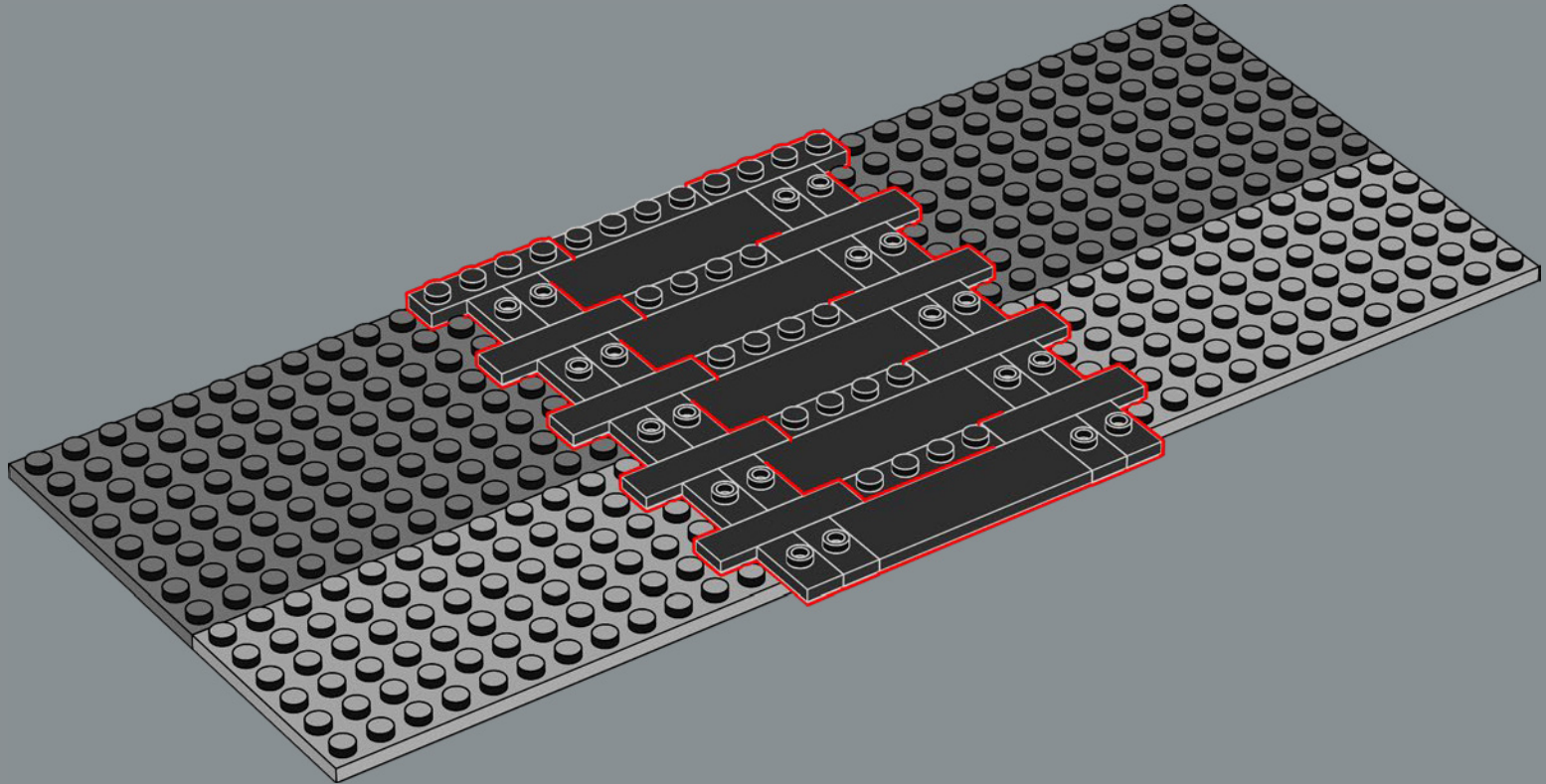

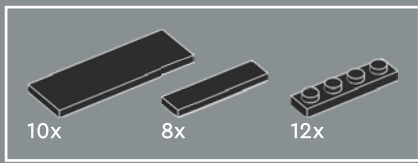

170

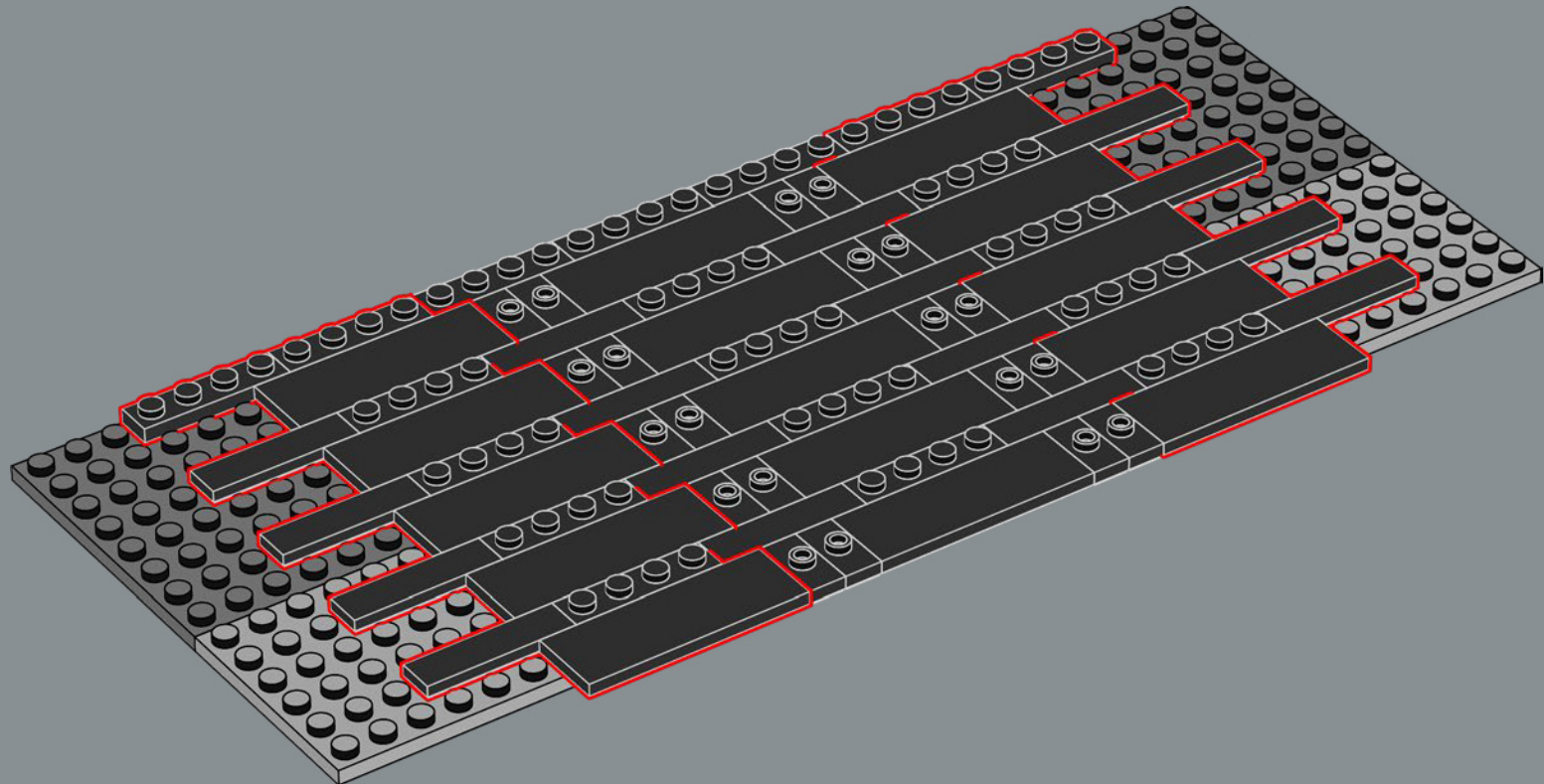



171

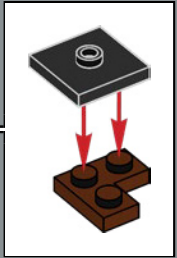
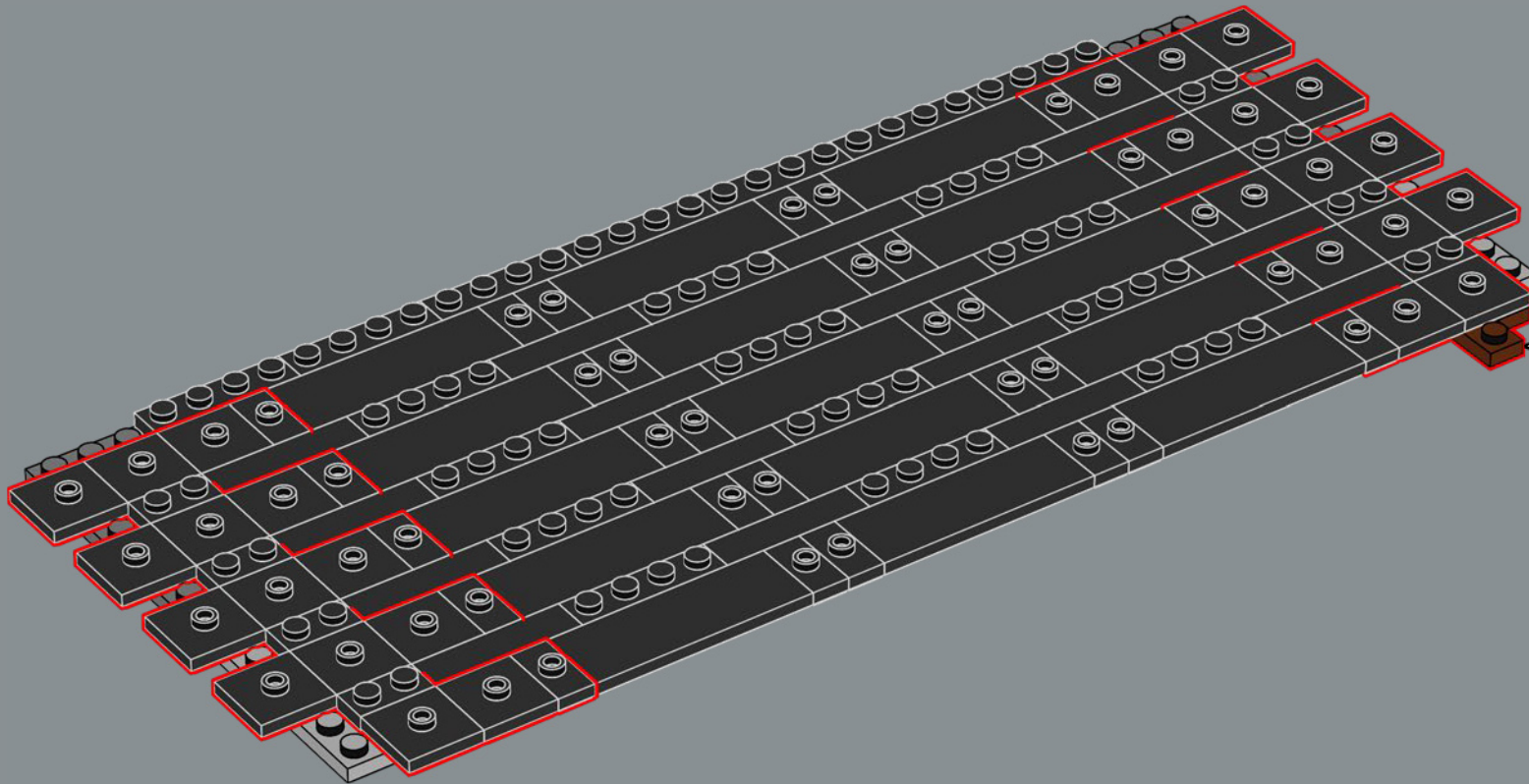

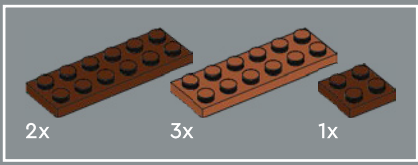

172

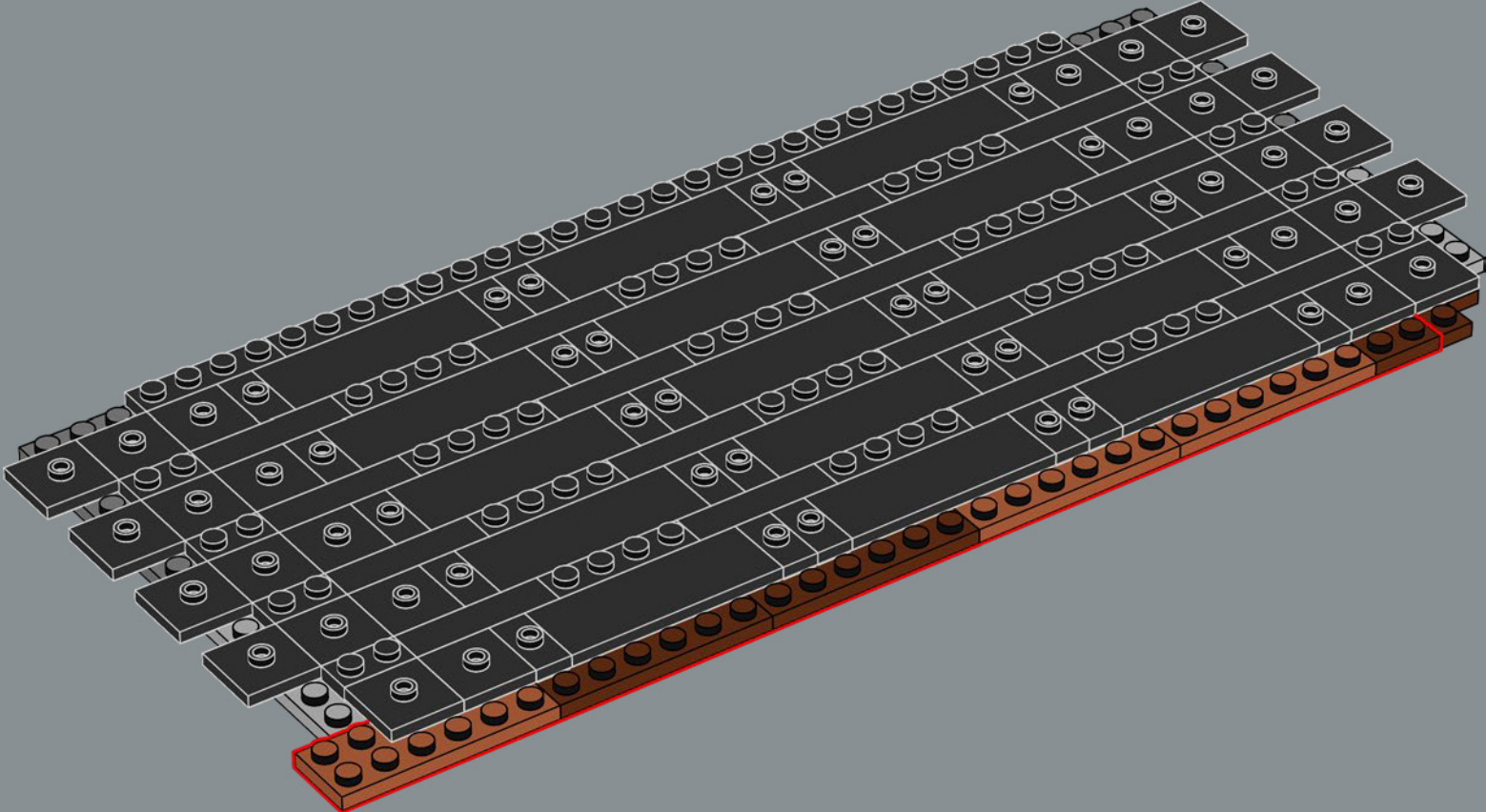

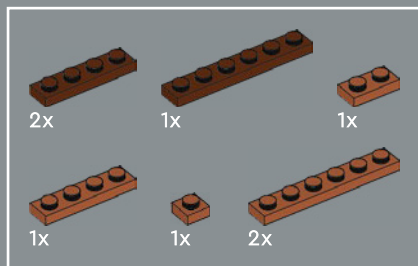

173

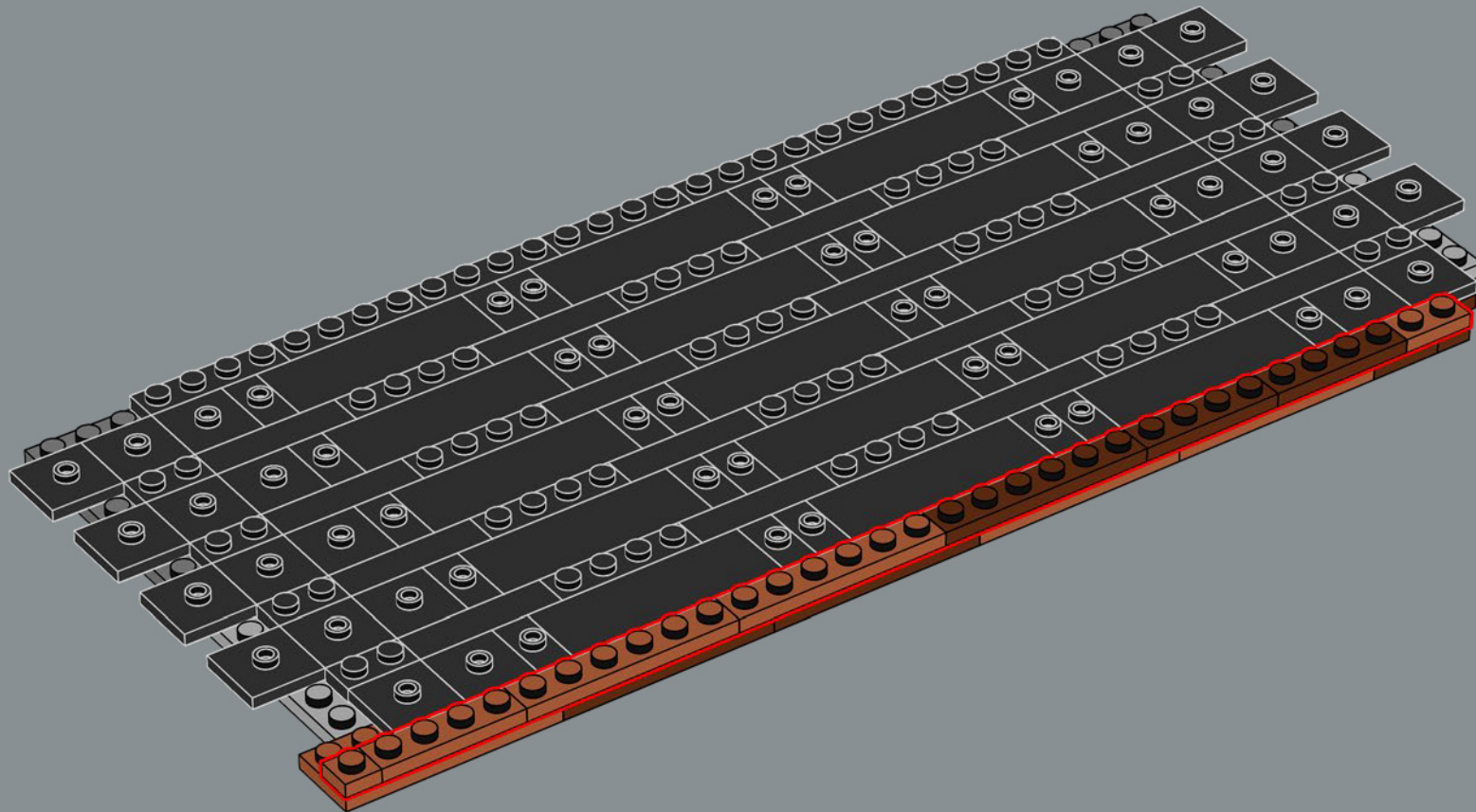

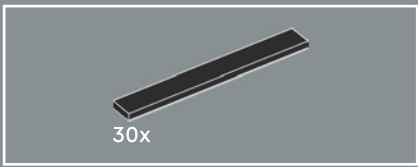

174

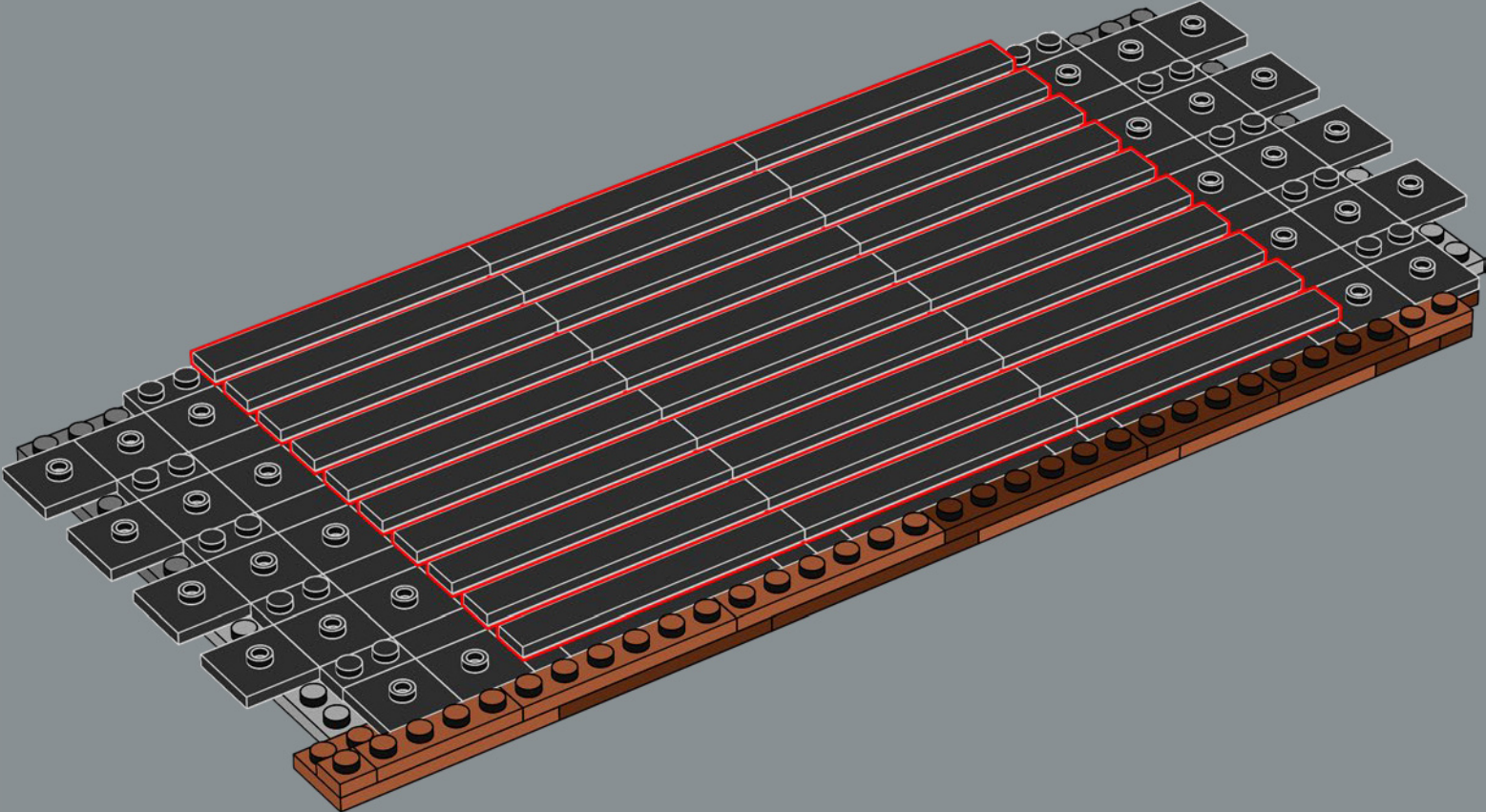

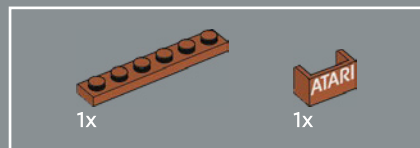
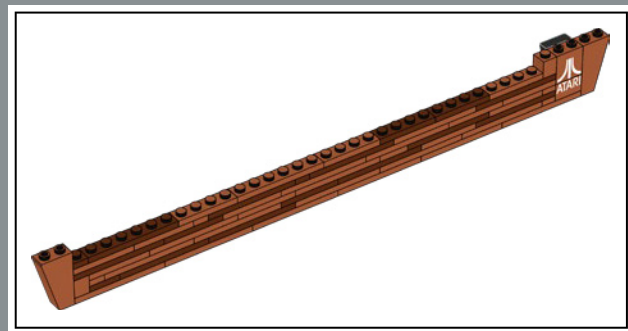

175

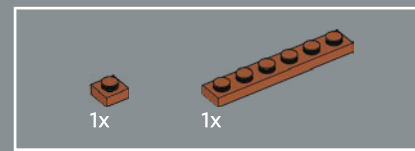
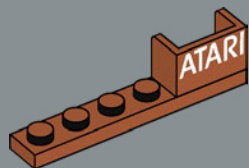

176

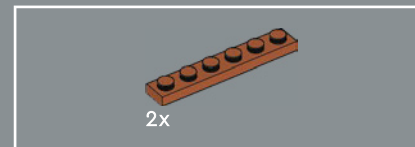
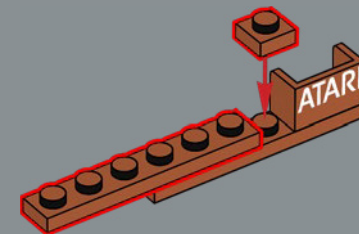

177

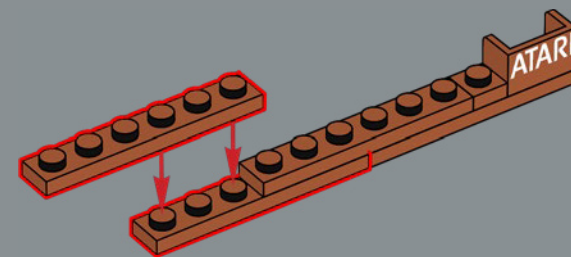

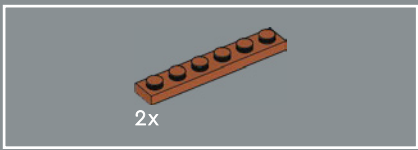

178

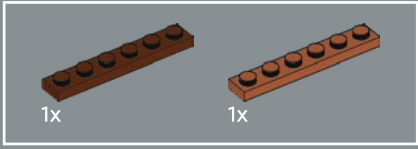
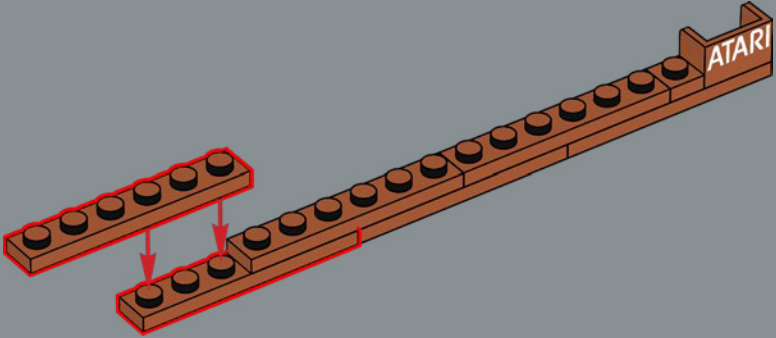

179

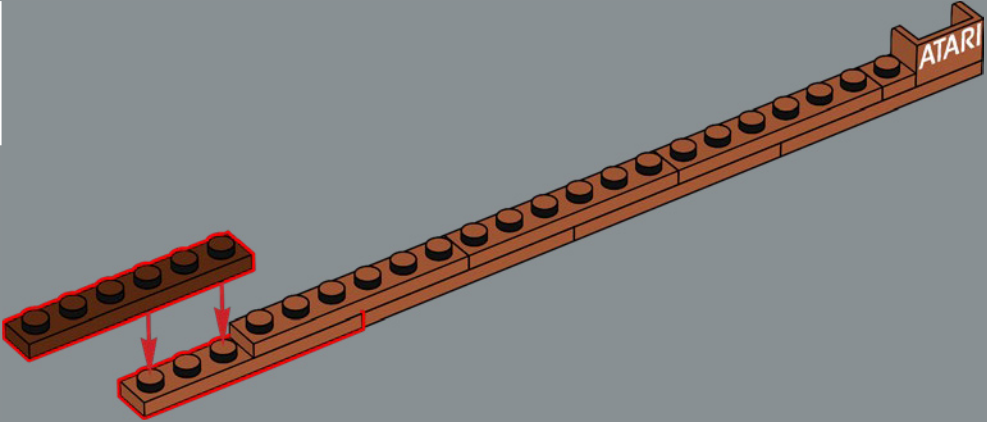

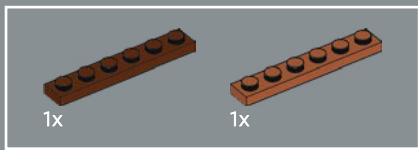

180

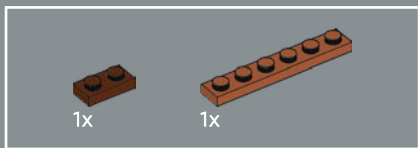
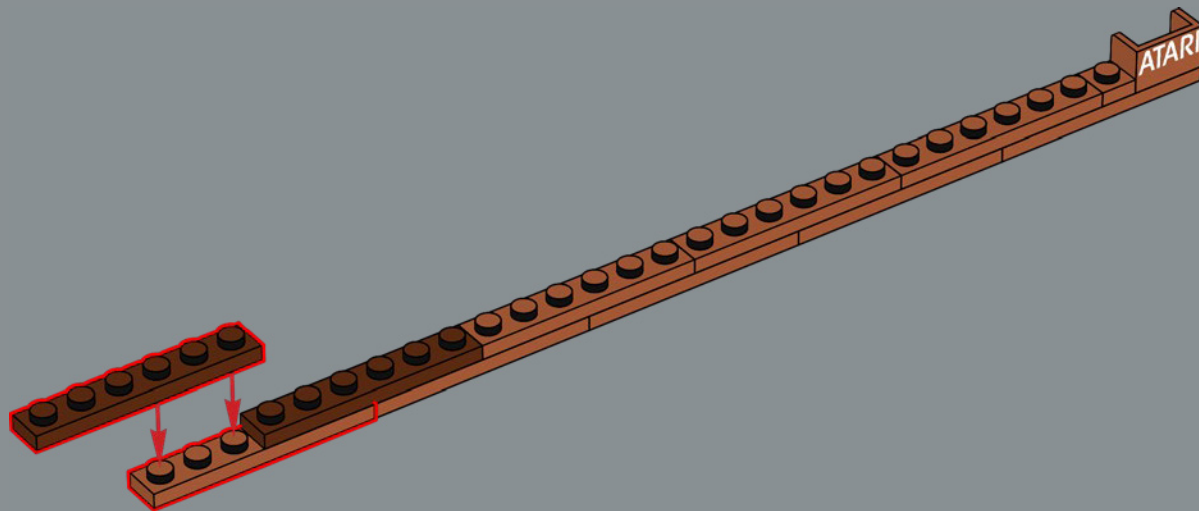

181

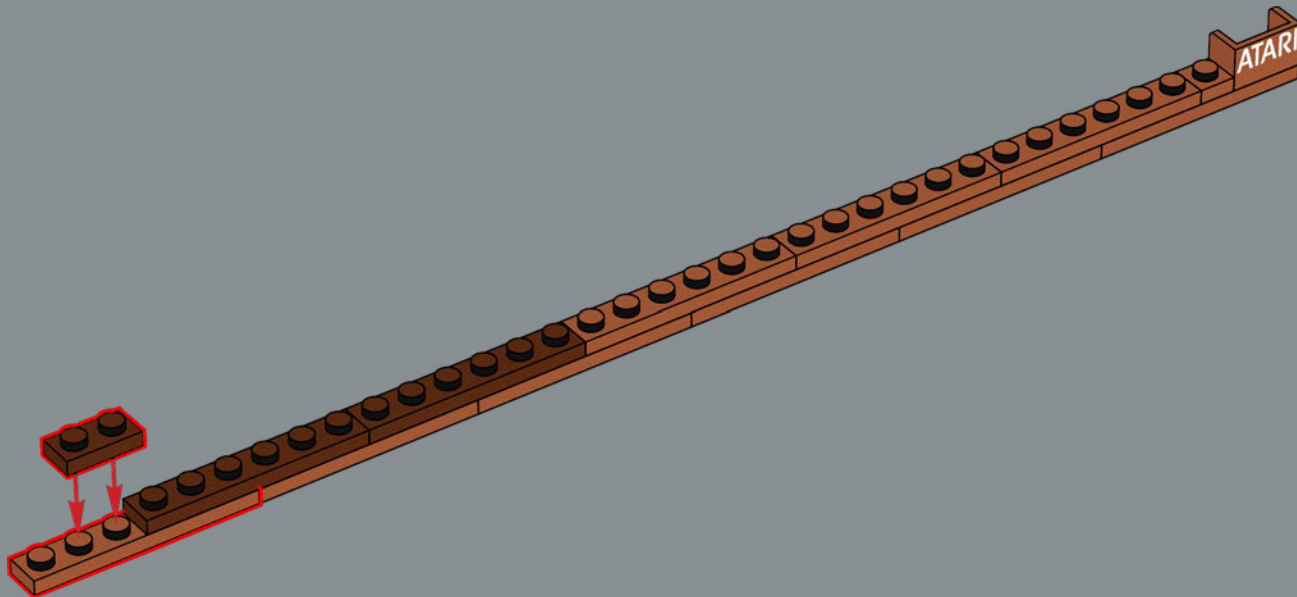

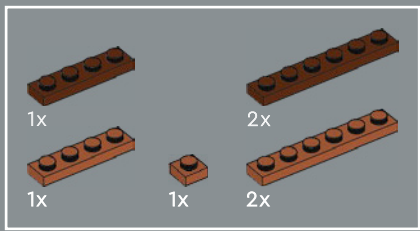

182

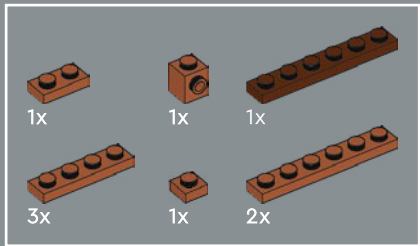
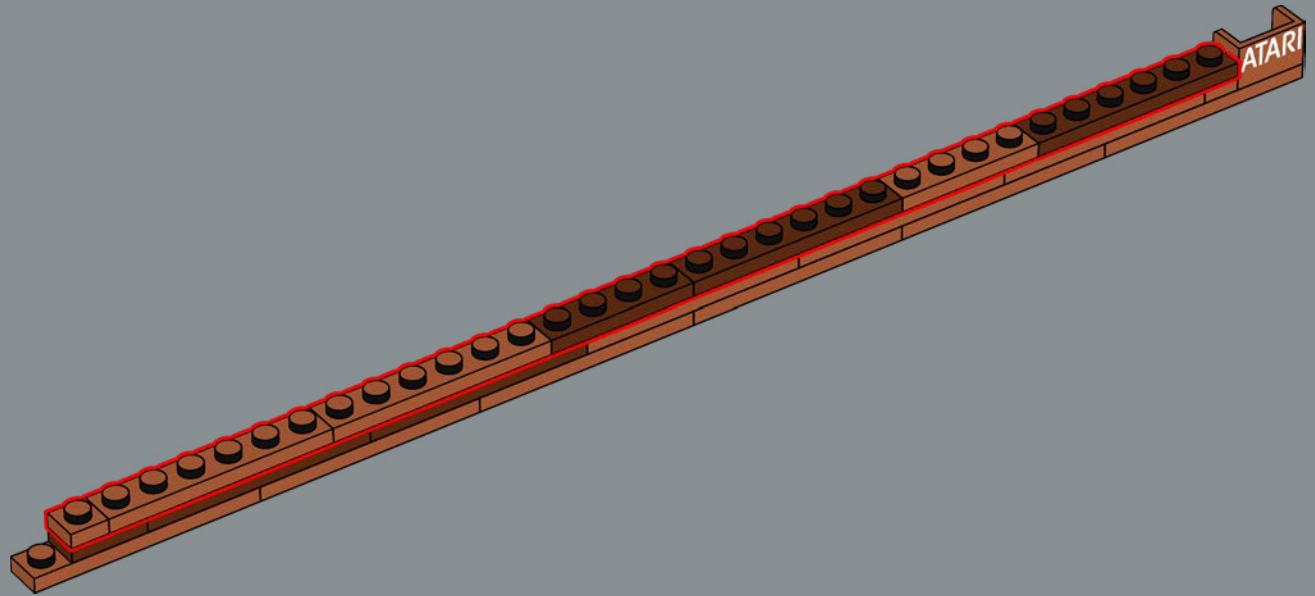

183

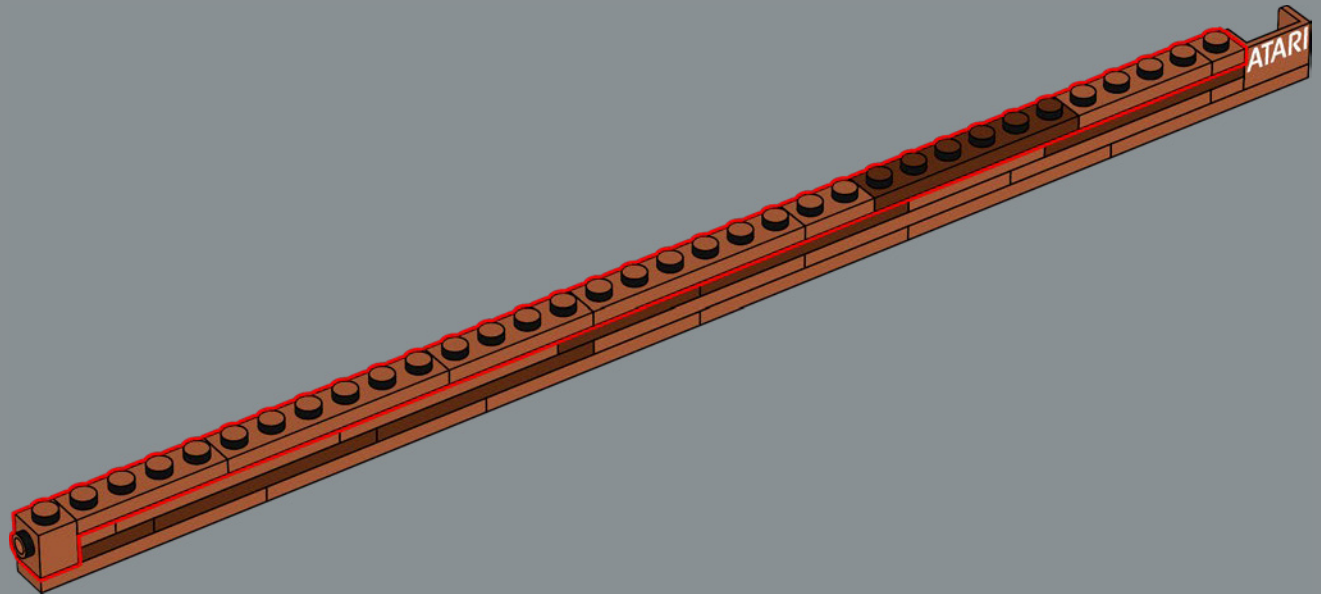

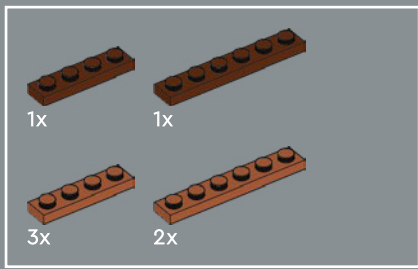

184

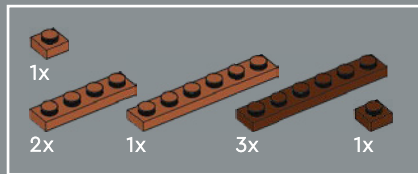
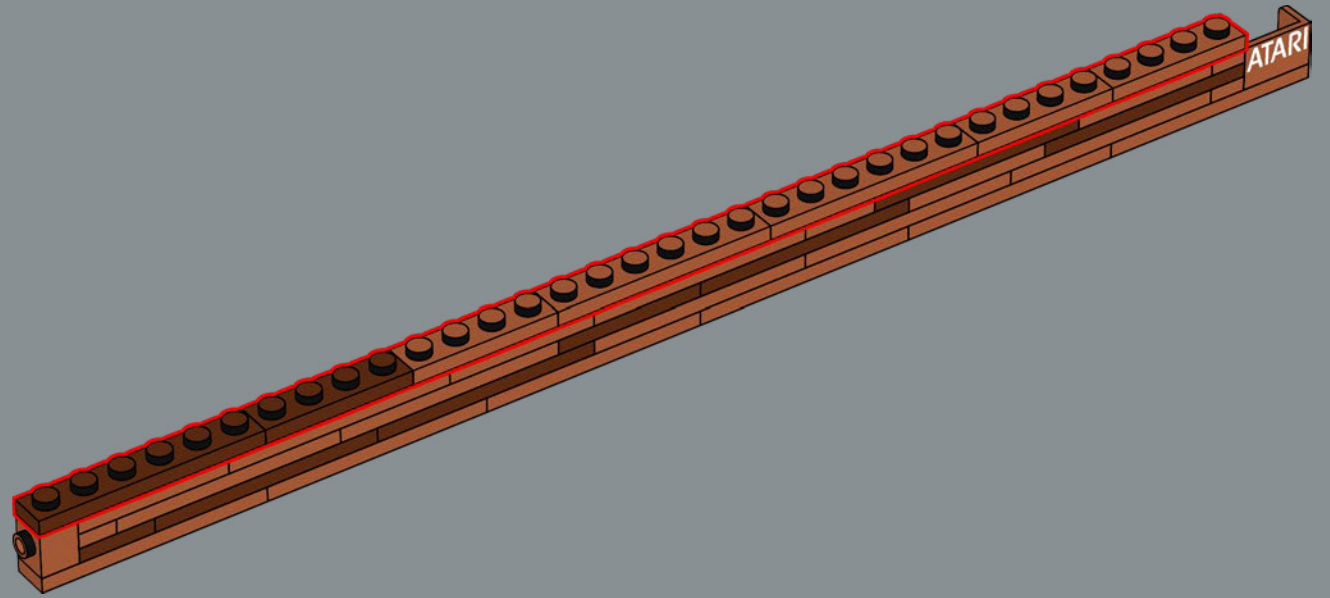

185

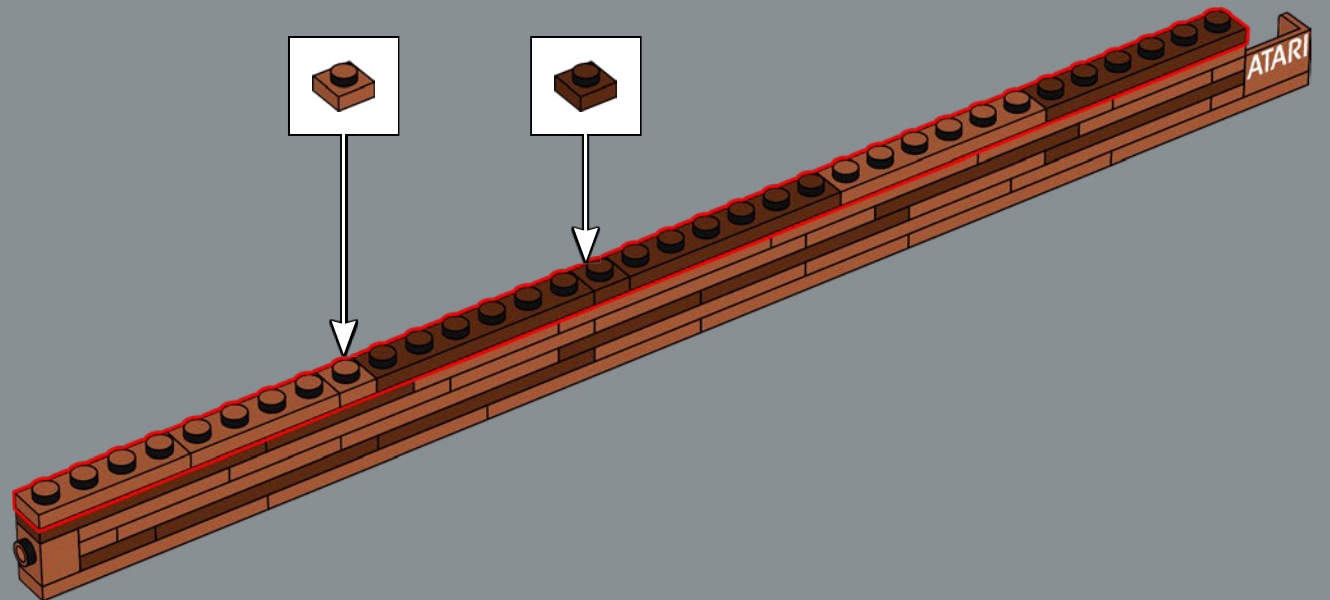

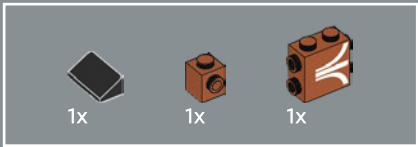

186

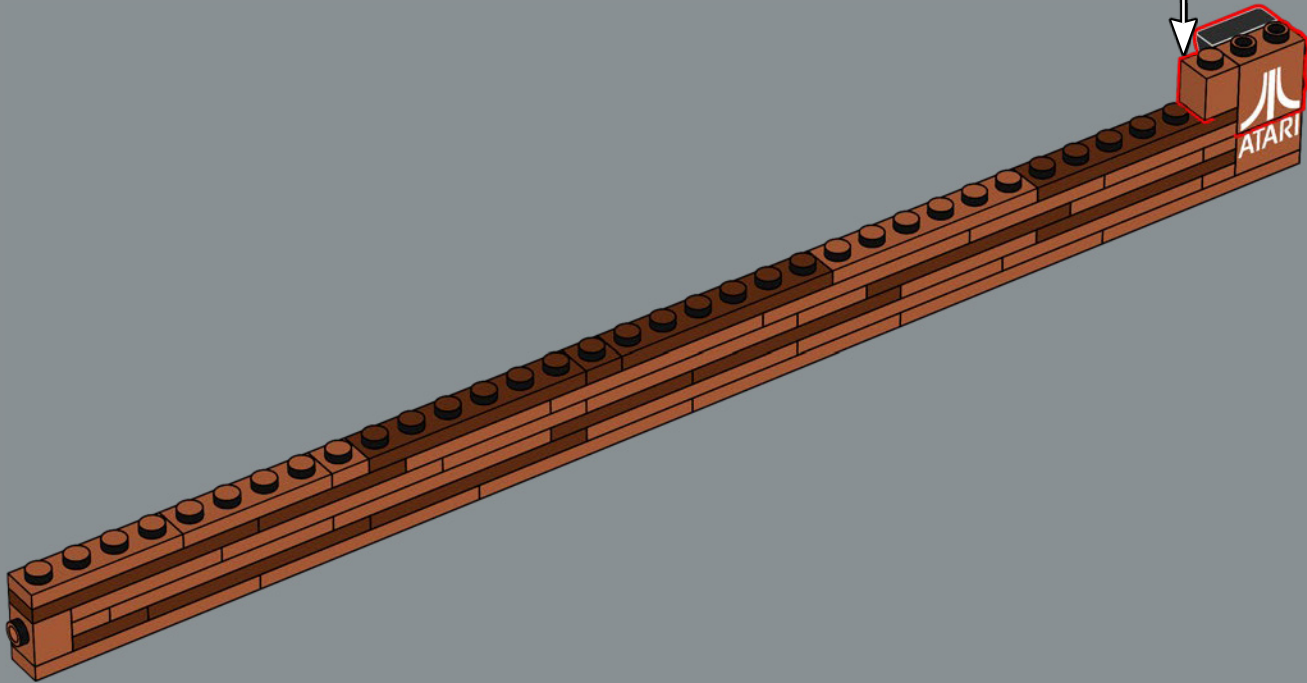
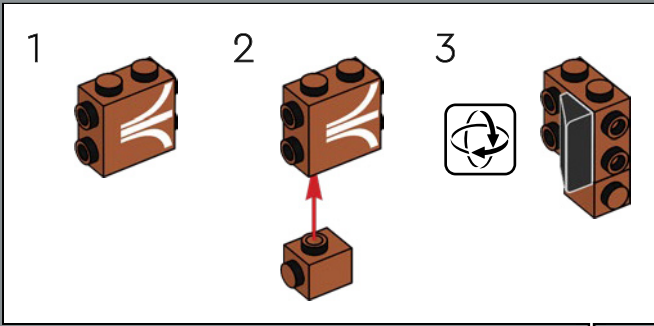

ATARI® was incorporated as a company on 27 June 1972.



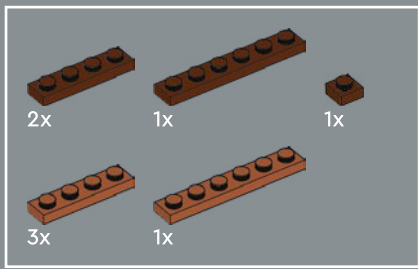

187

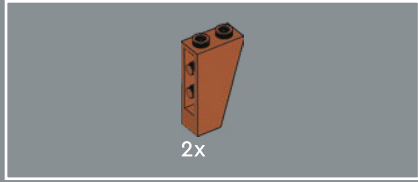
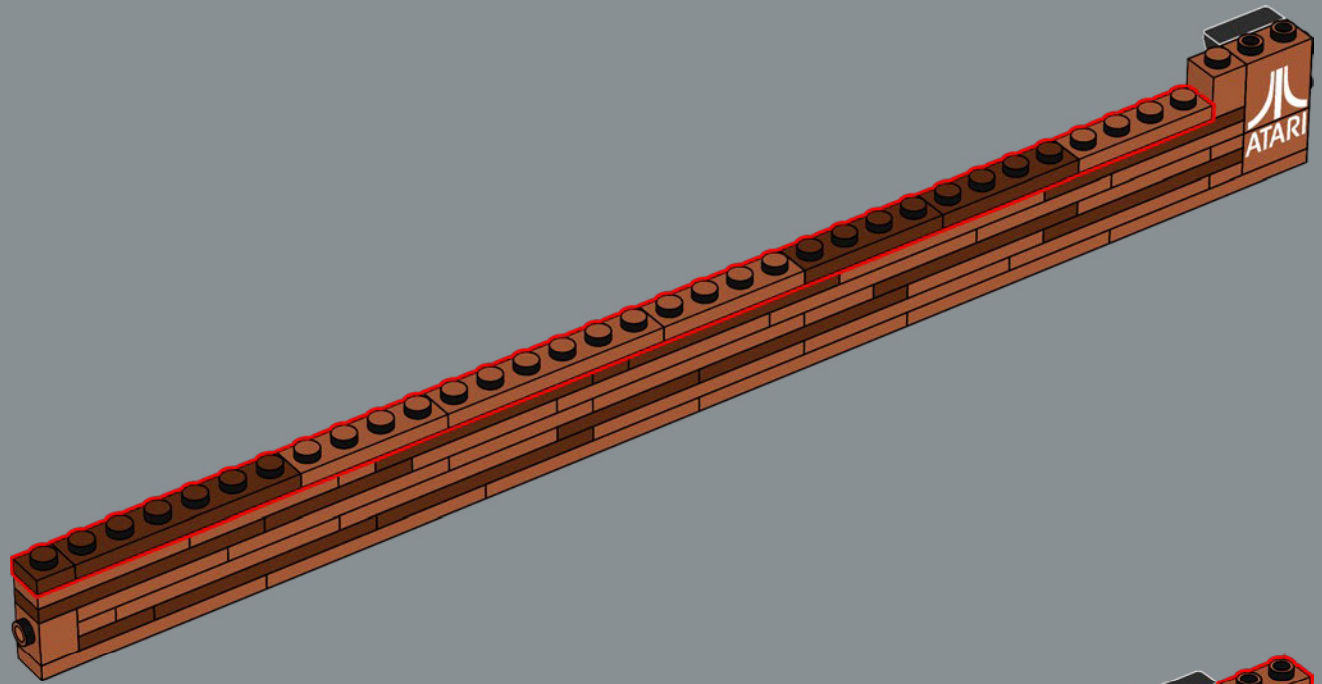

188

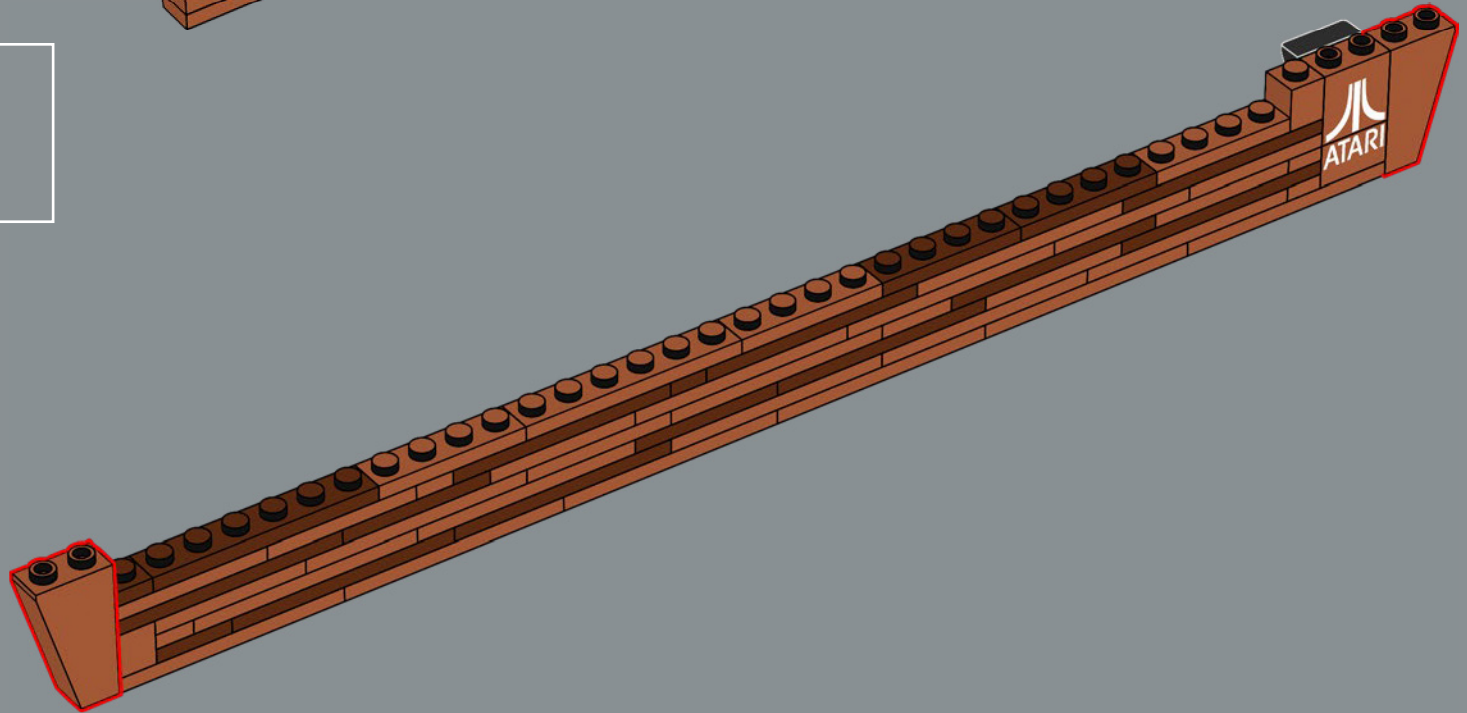

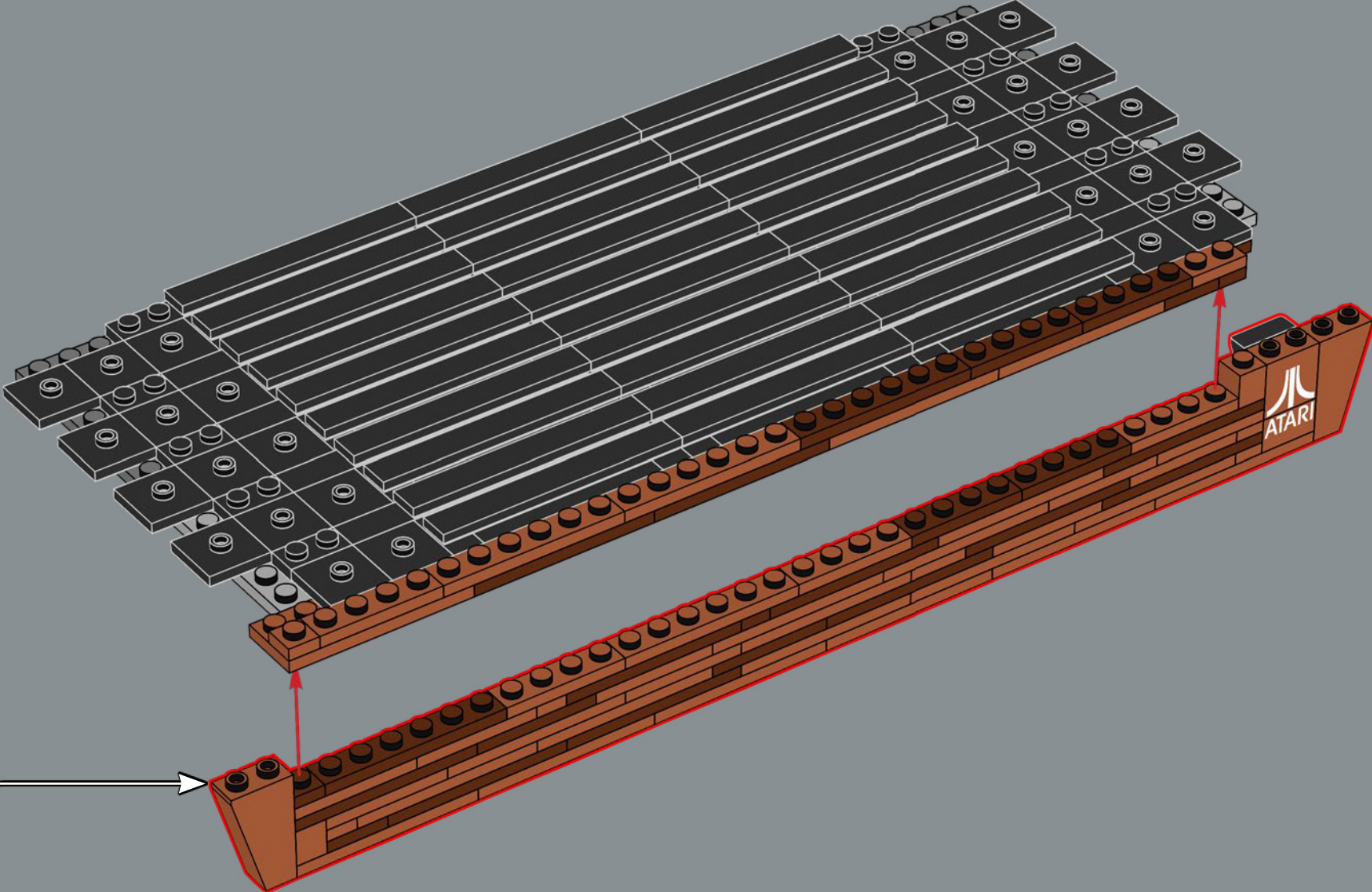

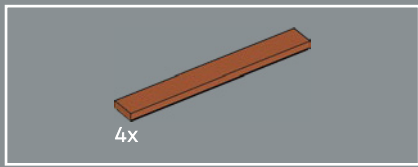

190

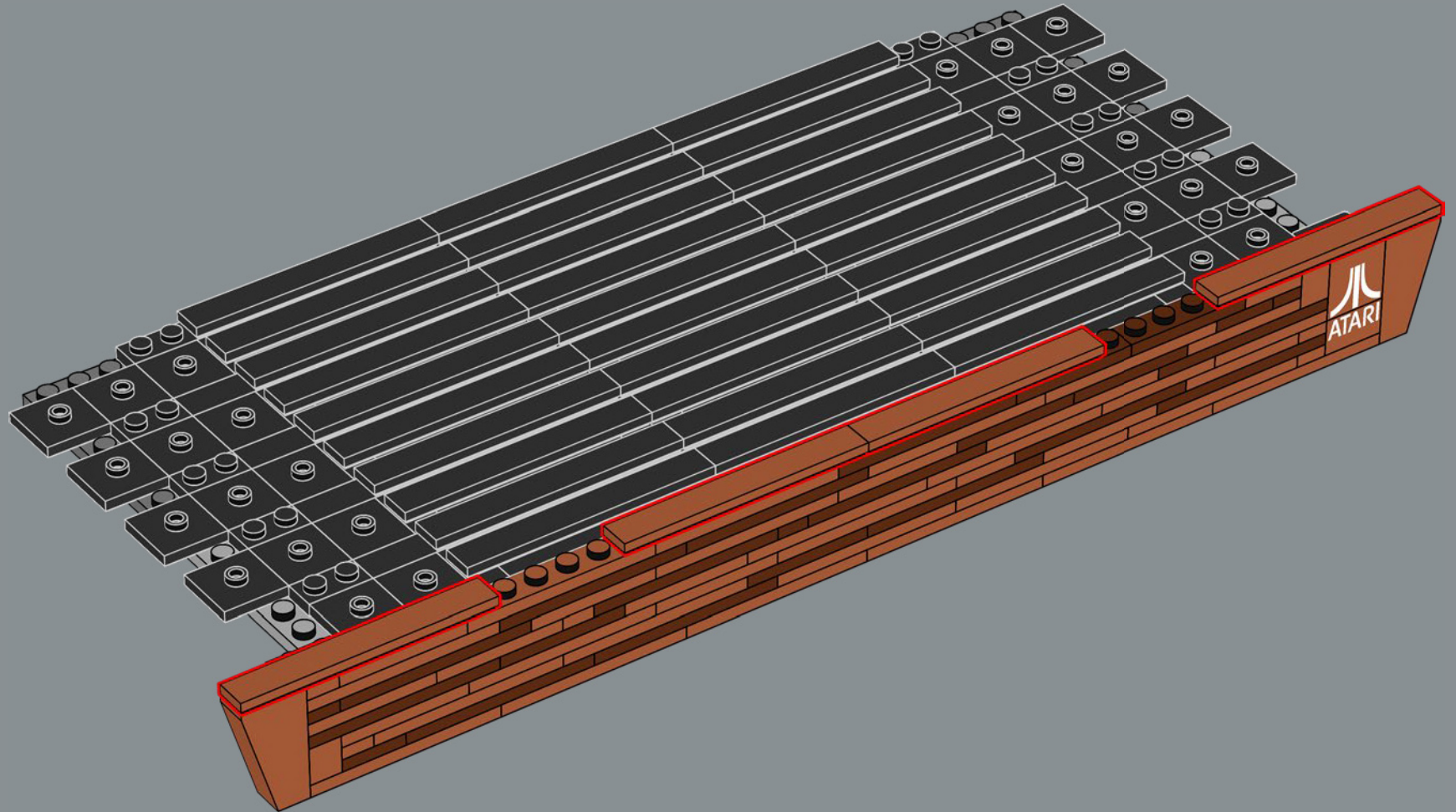

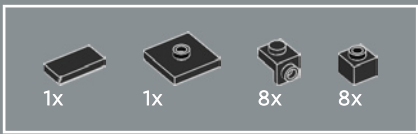

191

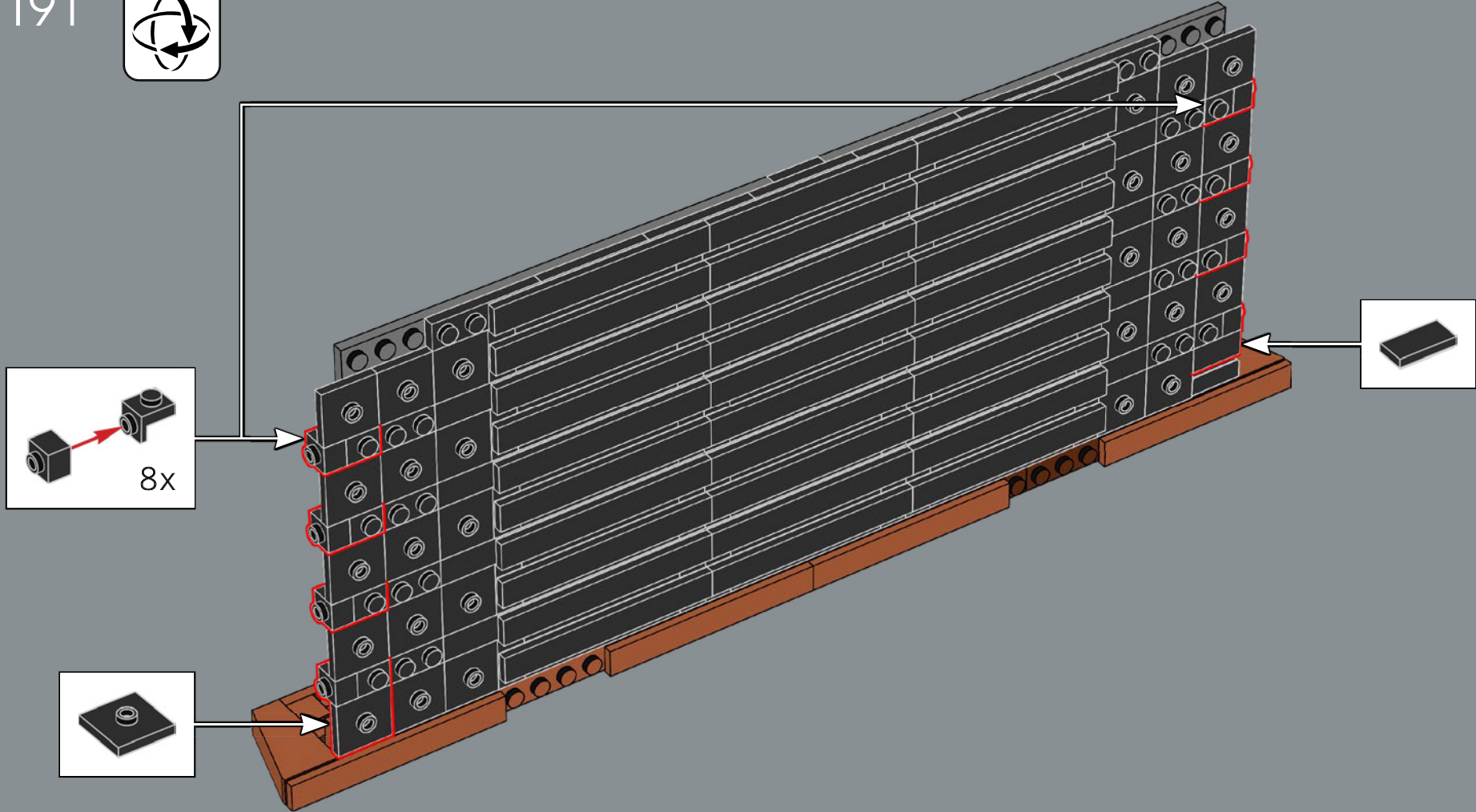

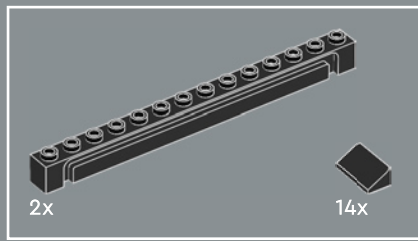

192

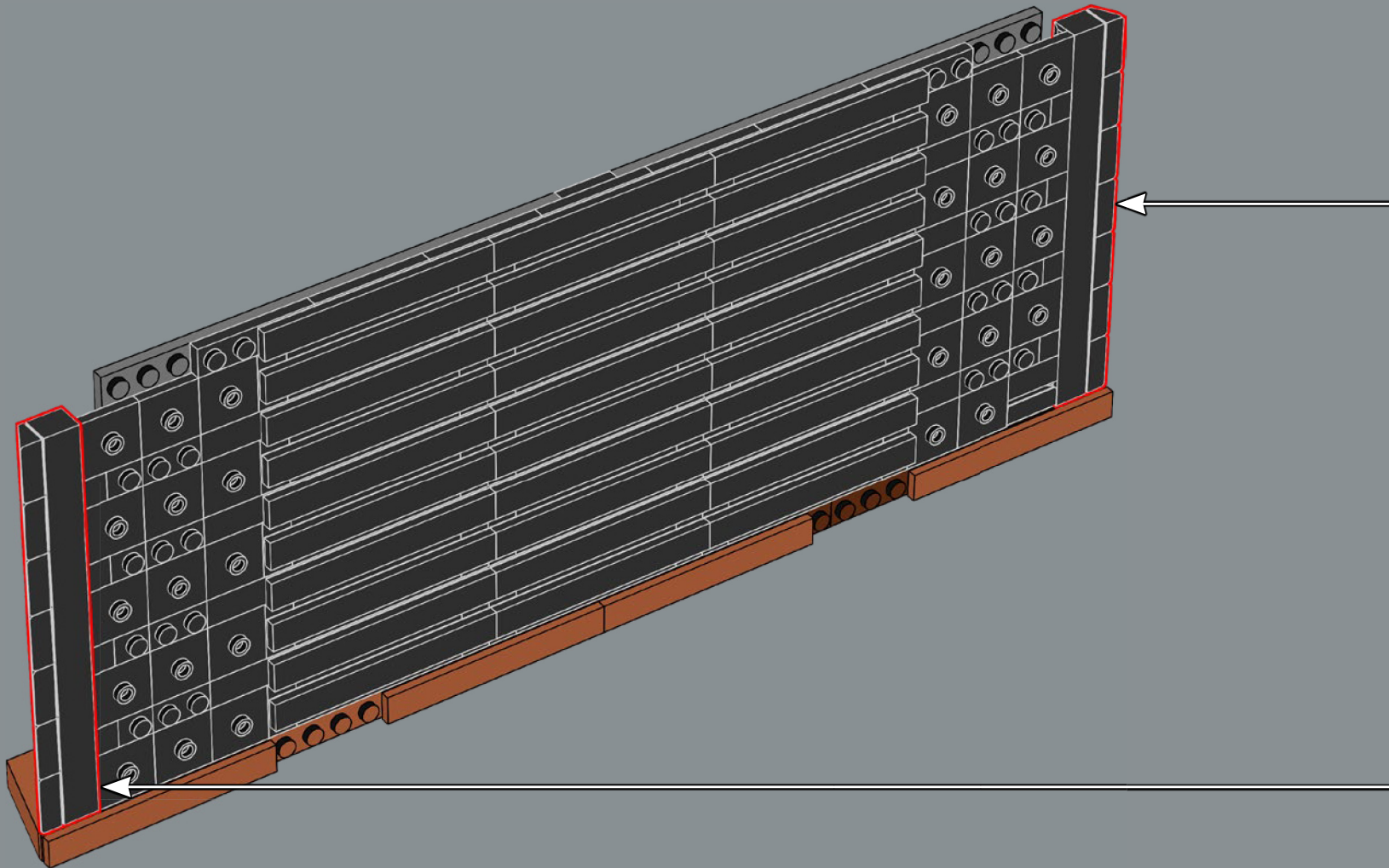
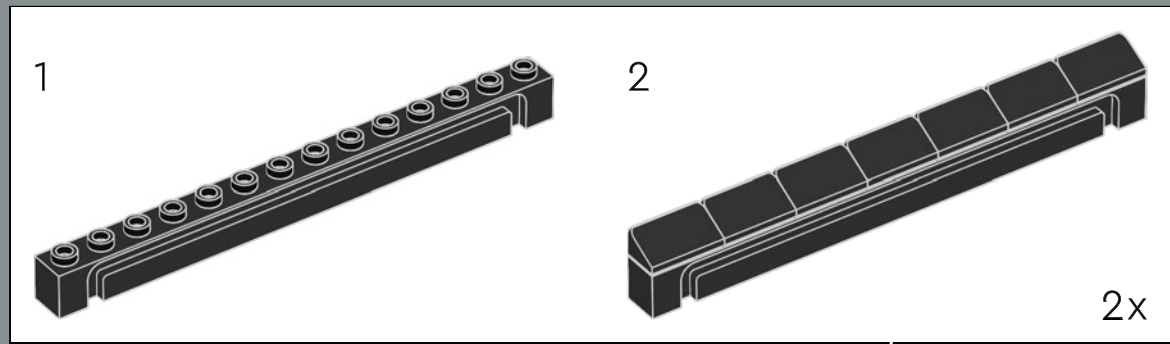

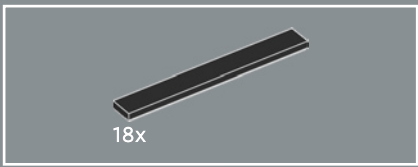

193

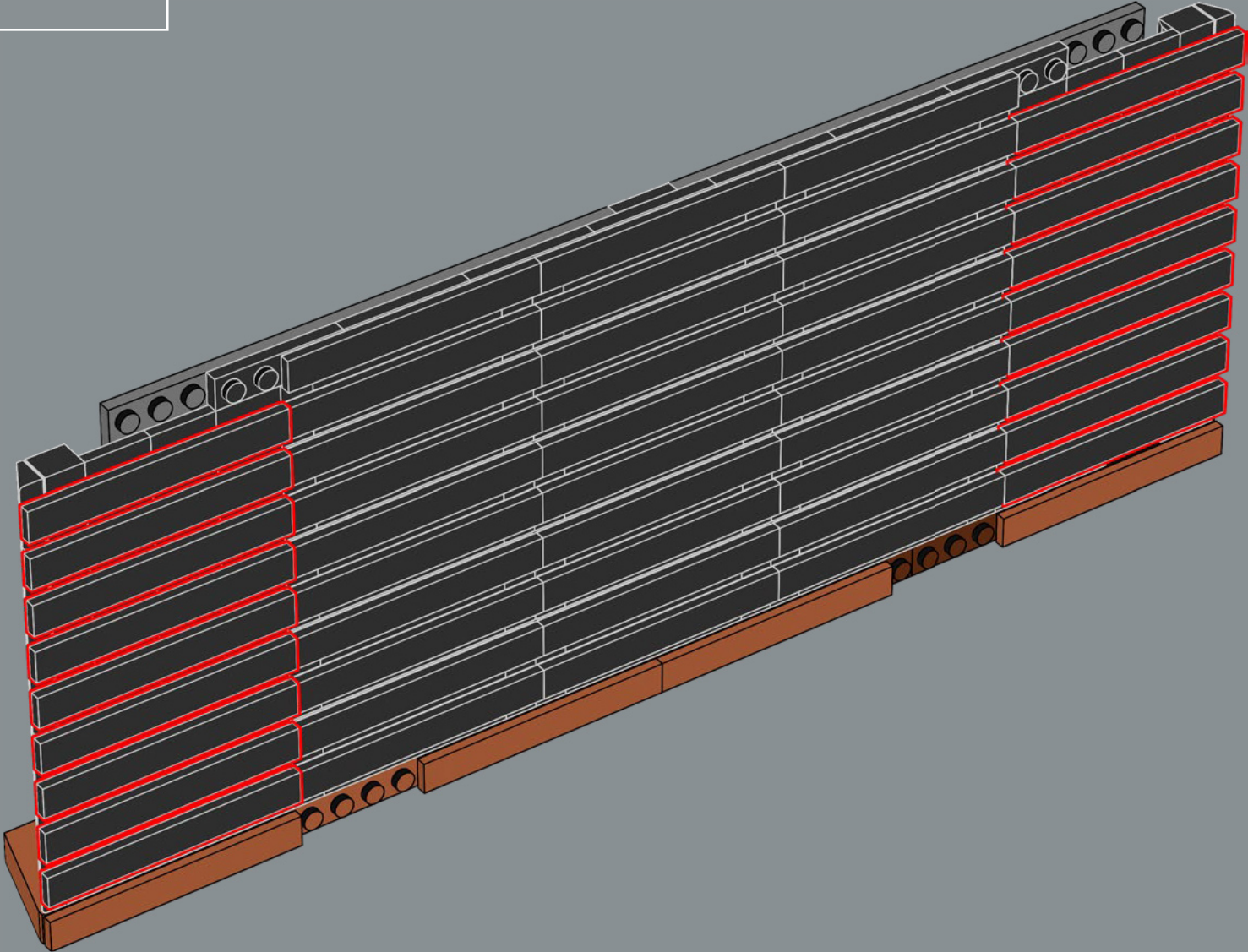



194

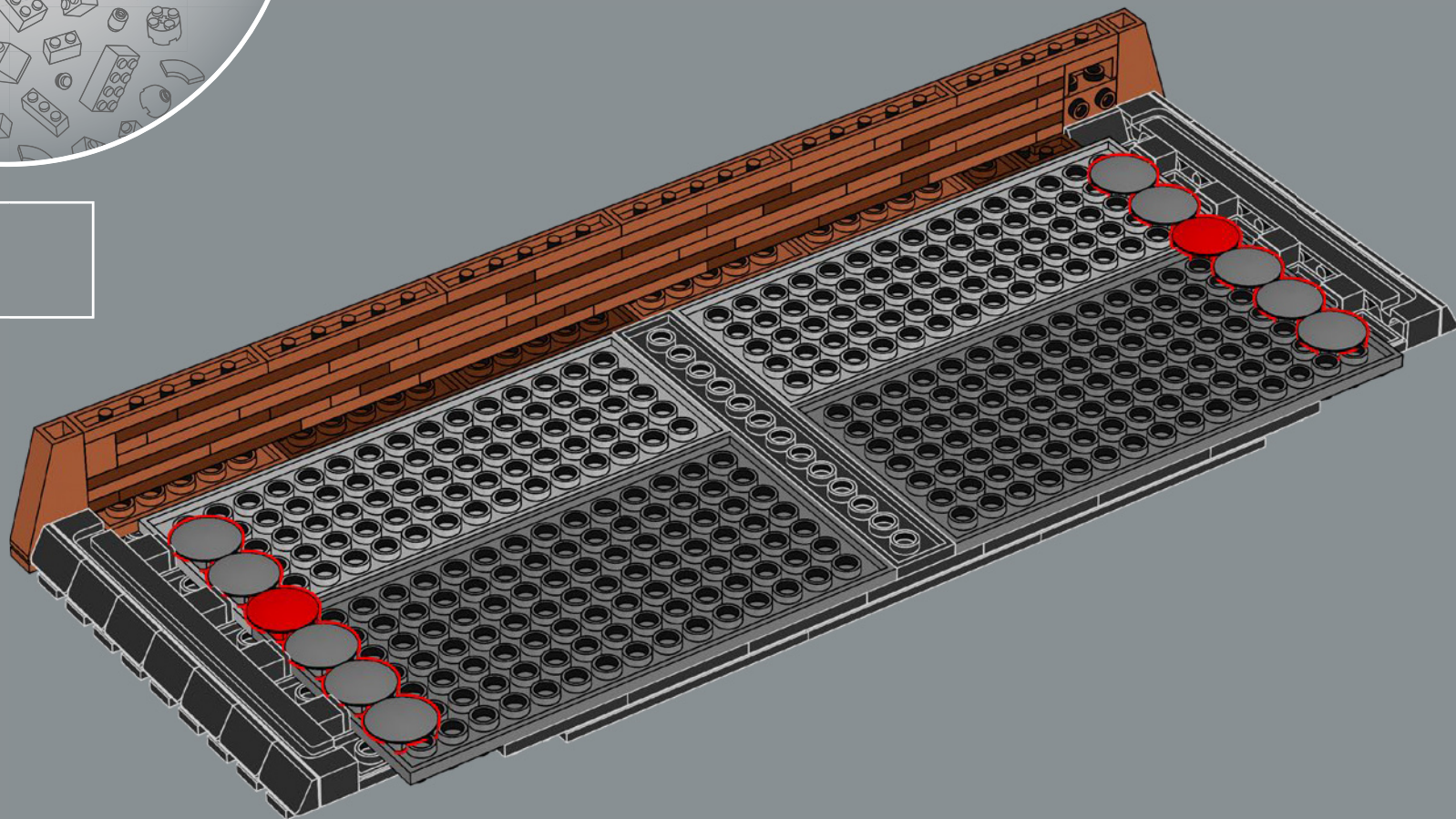

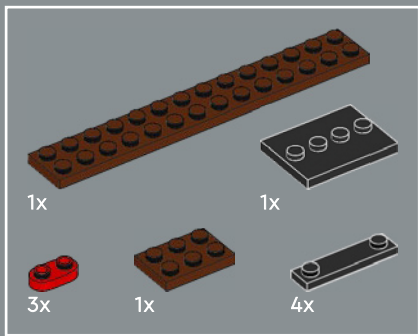

195

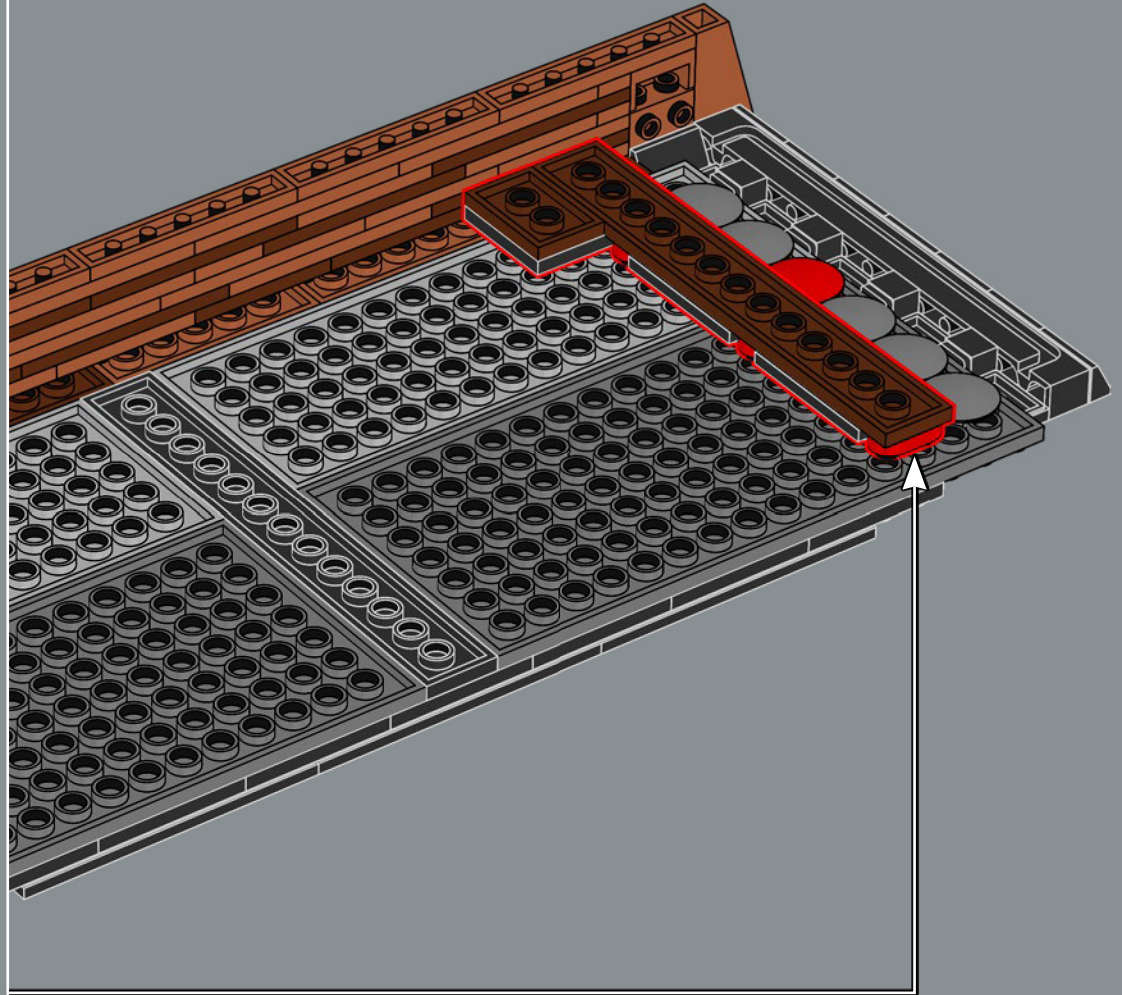
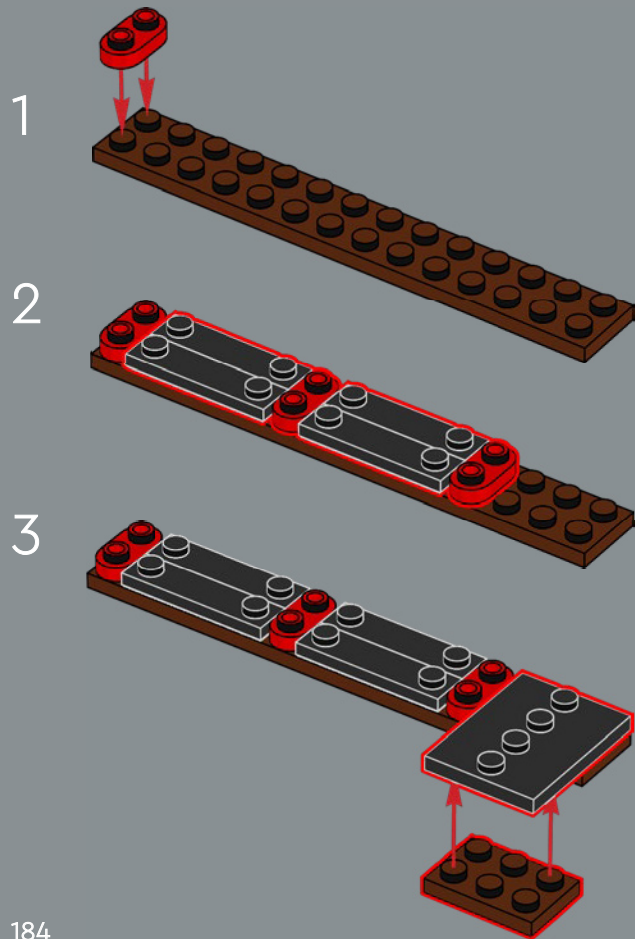

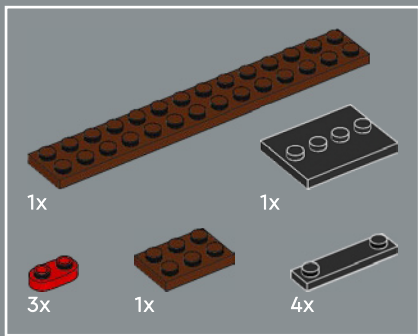

196

1

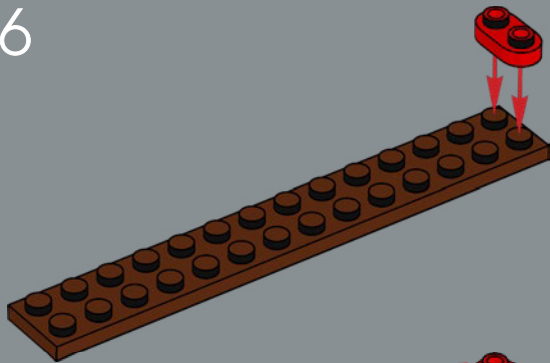

2

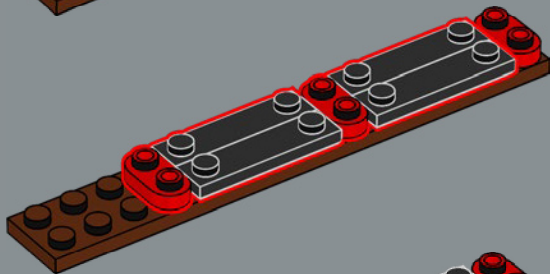

3

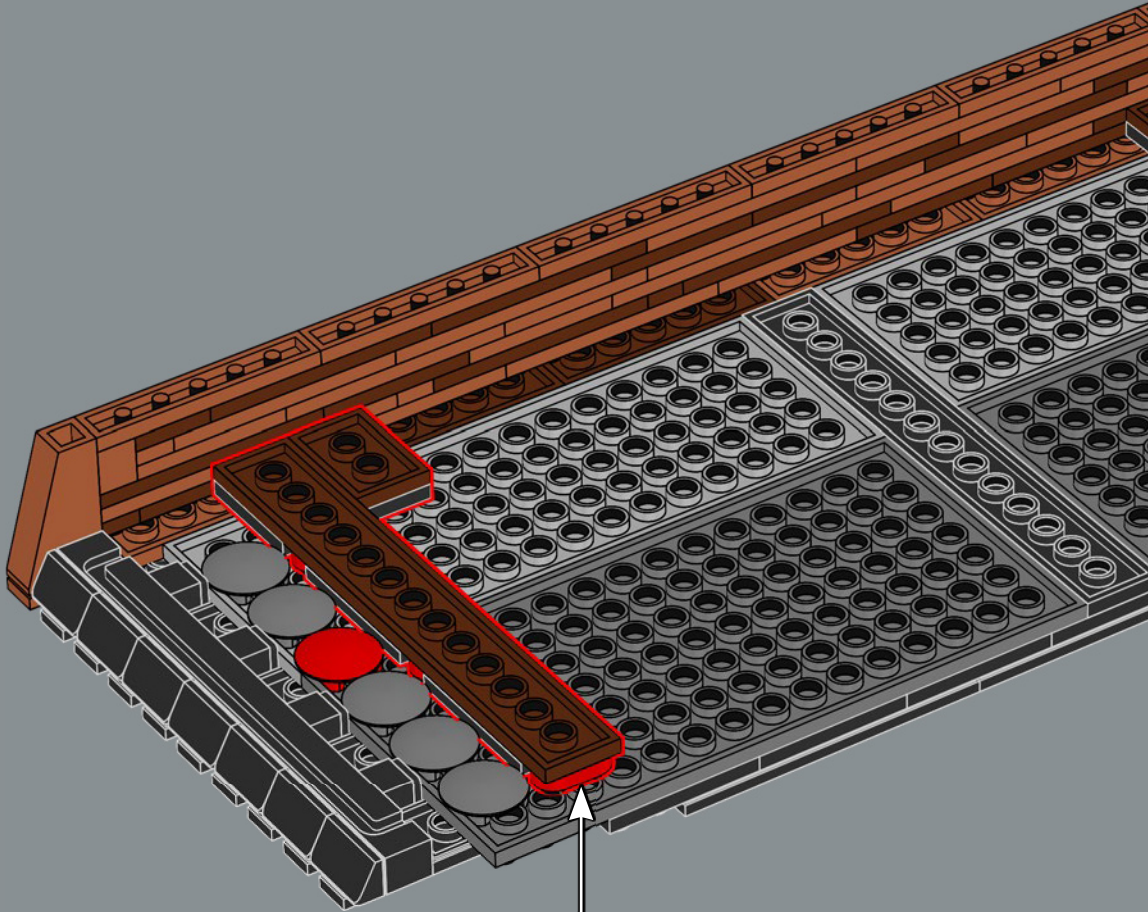
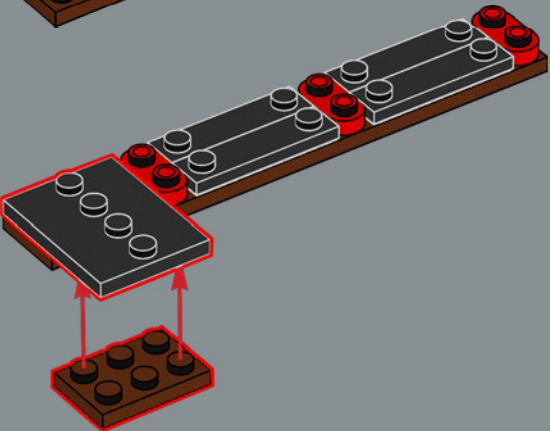

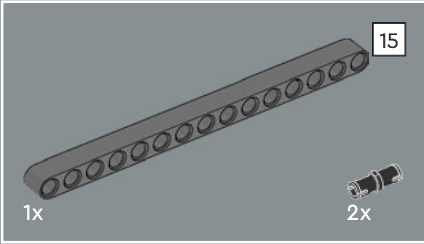
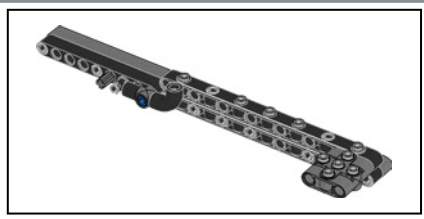

197

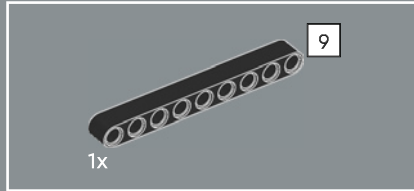
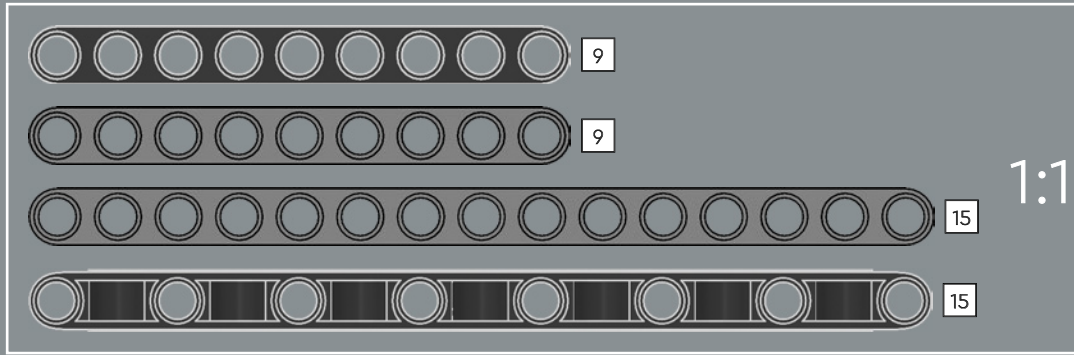

198



199

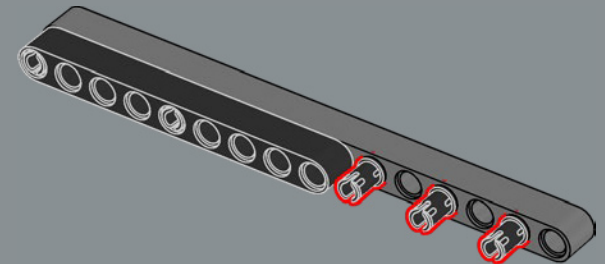
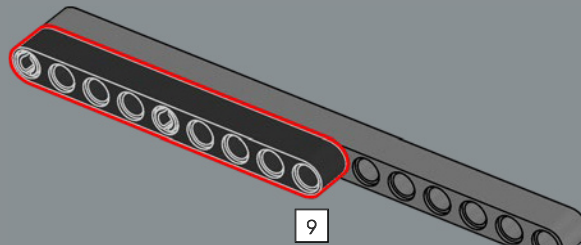
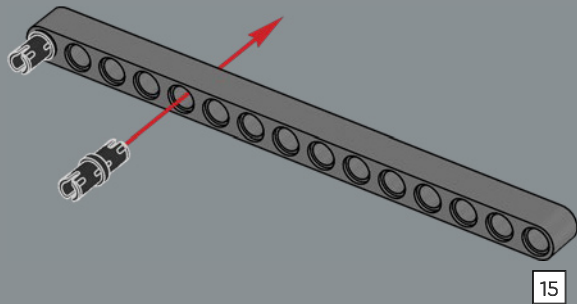

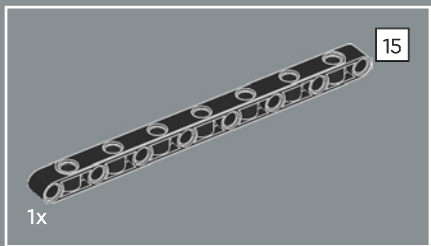

200

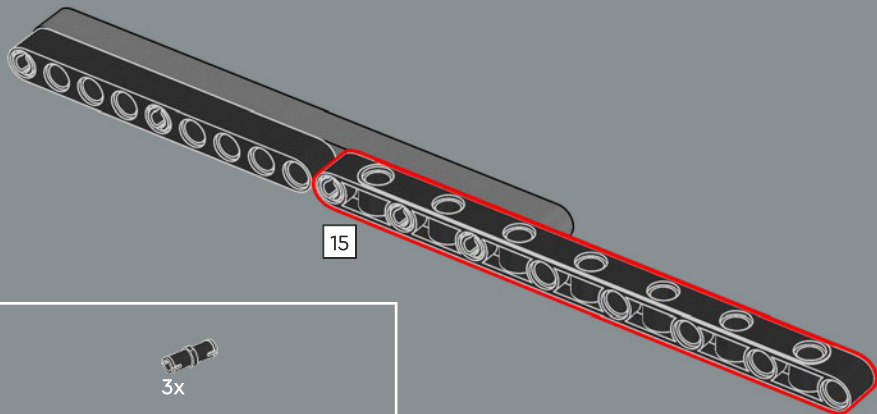

201

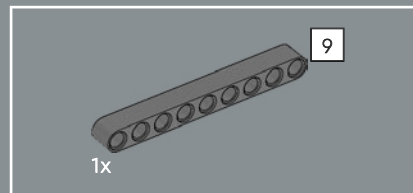
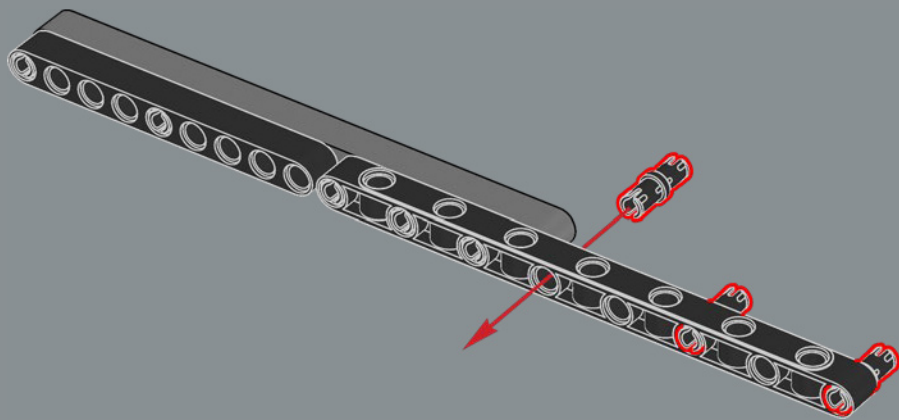

202

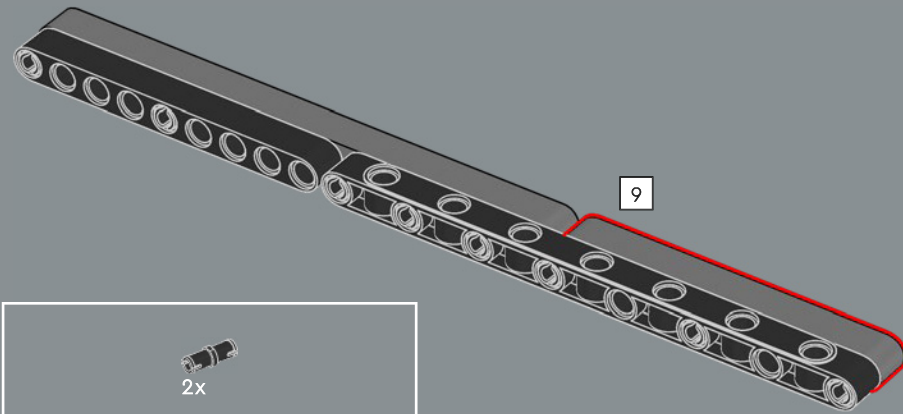

203

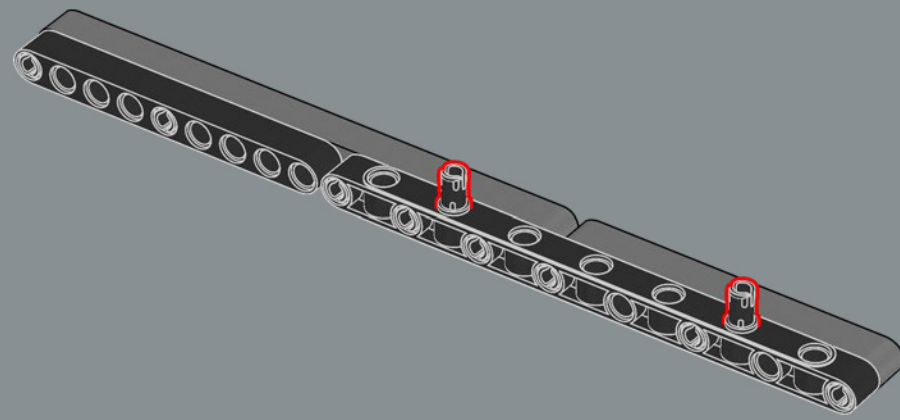

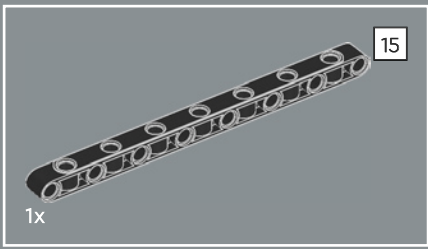

204

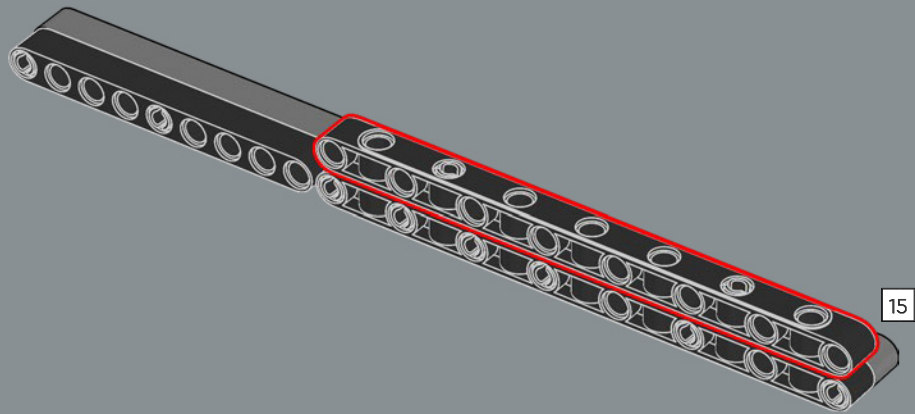

205

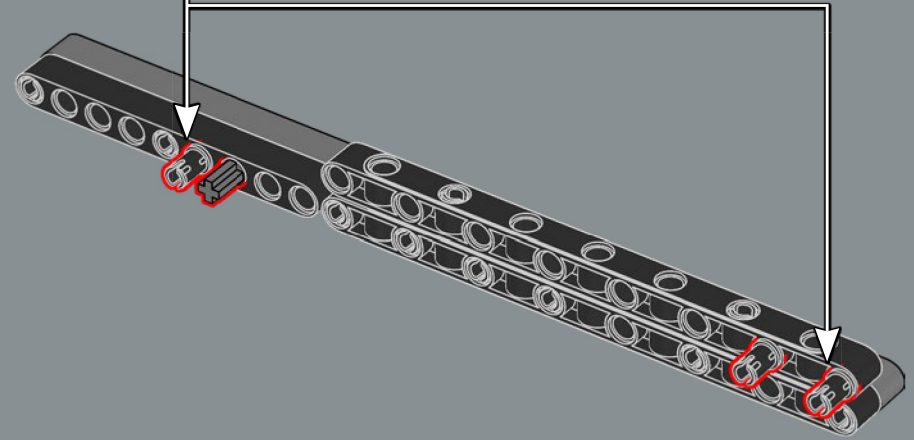
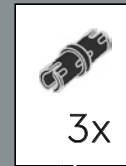

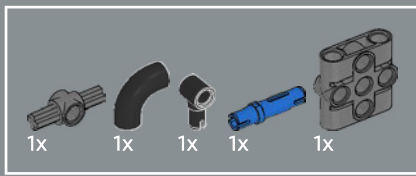

206

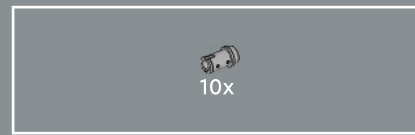
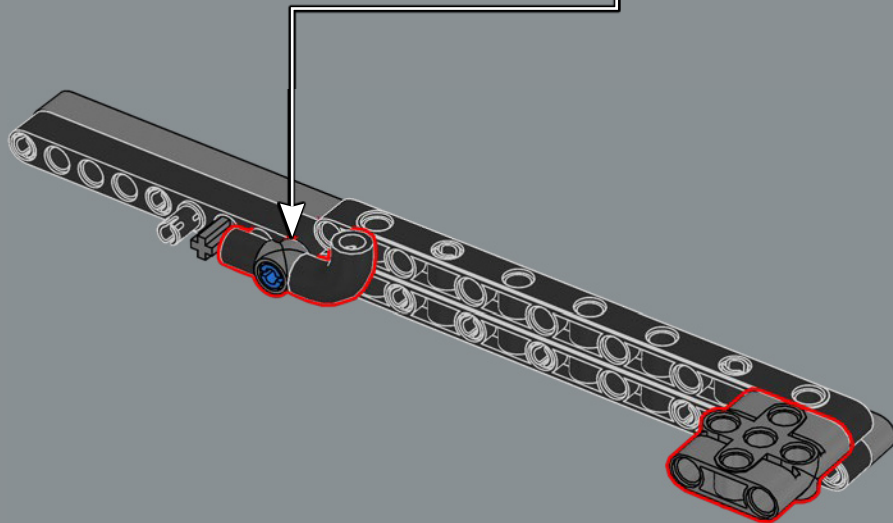
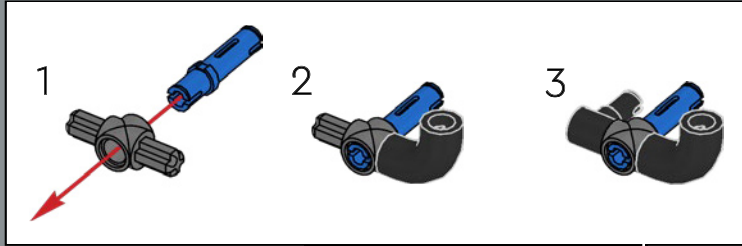

207

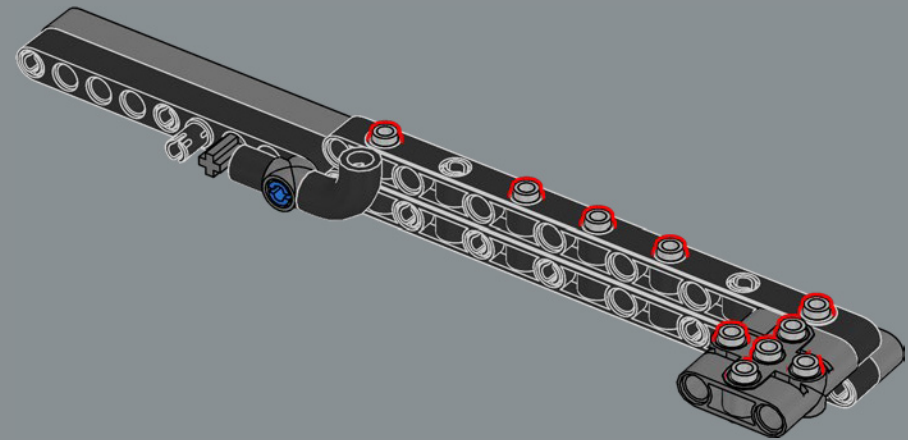

208

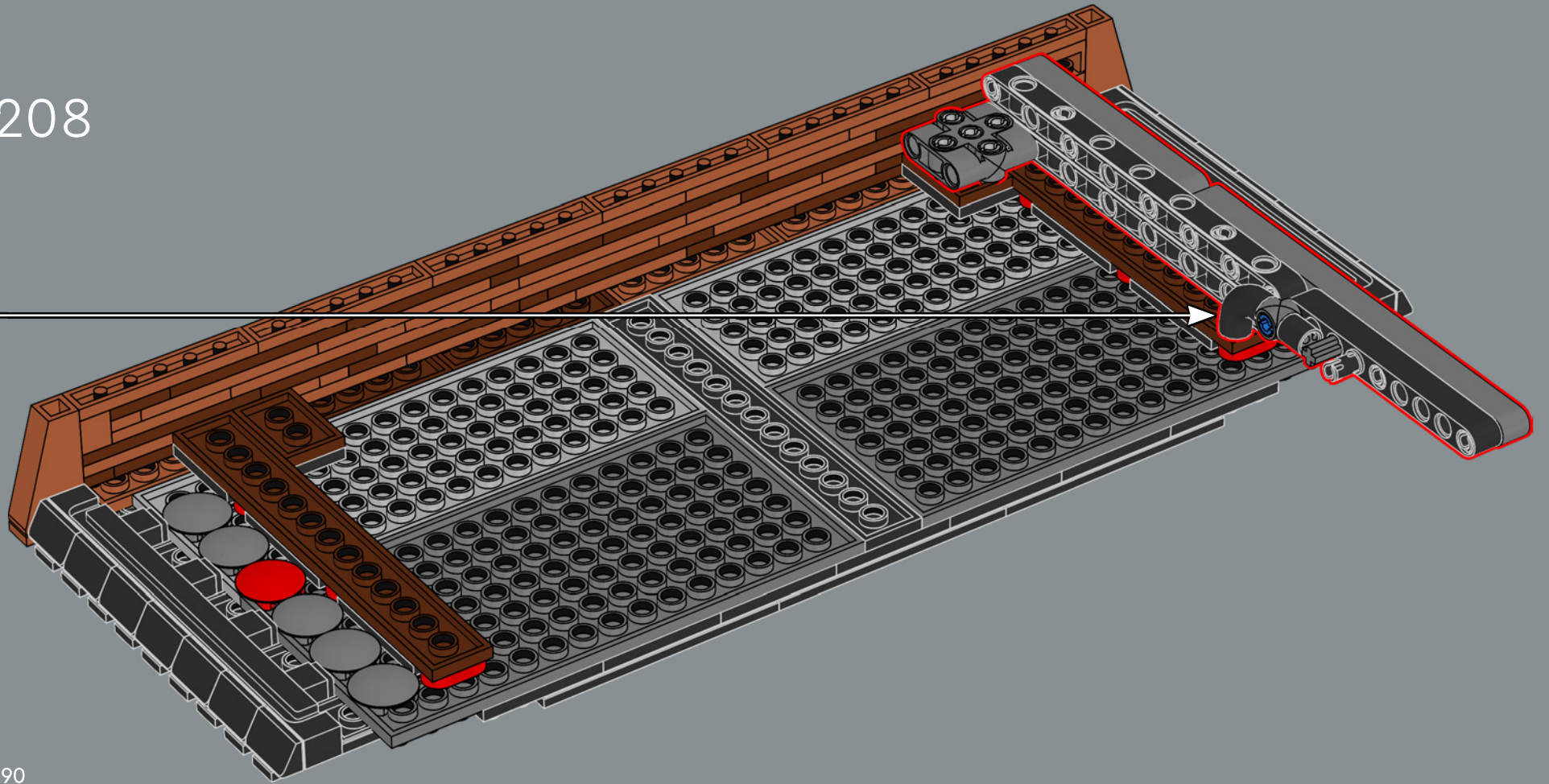

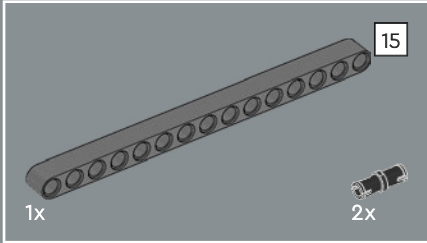
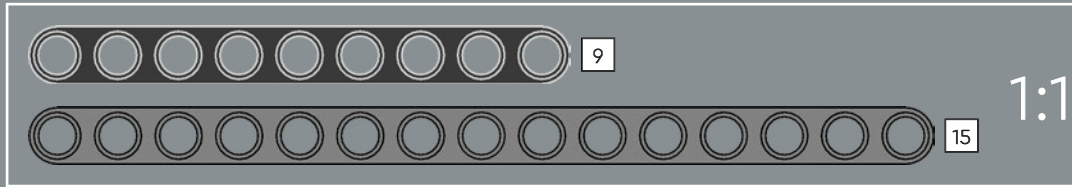
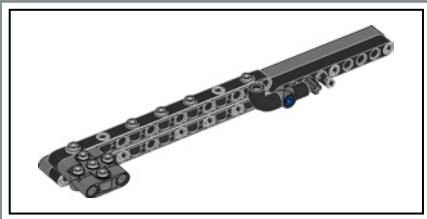

209

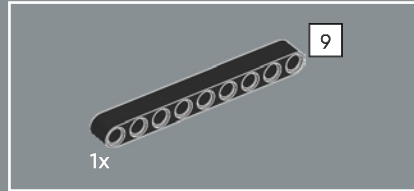

210



211

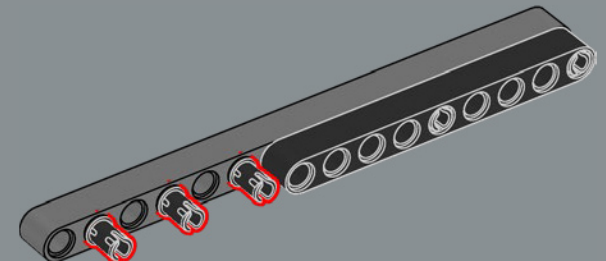
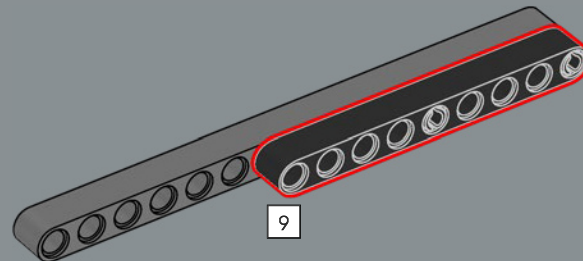
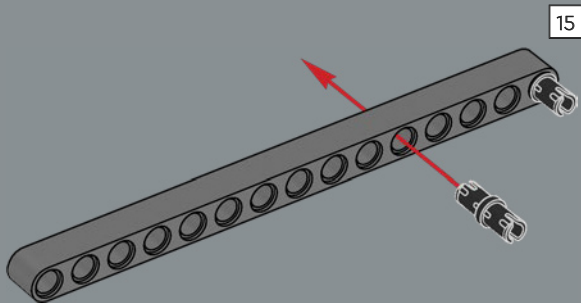

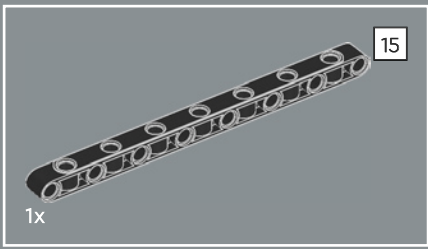

212

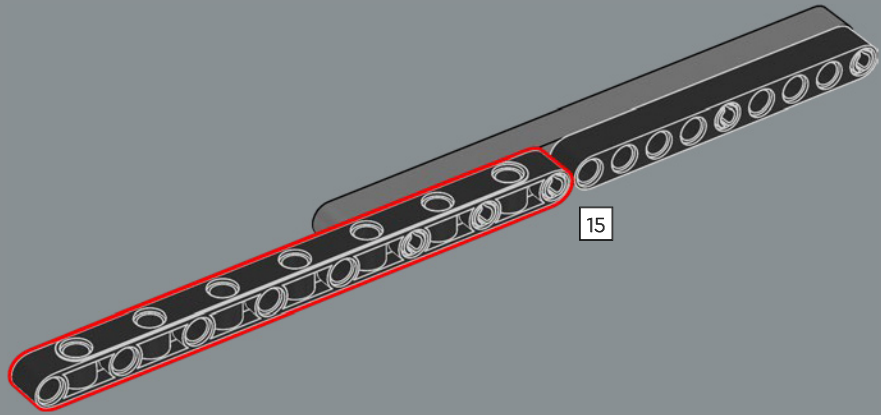

213

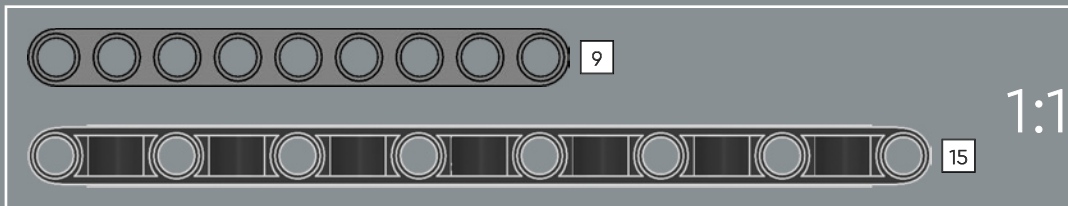
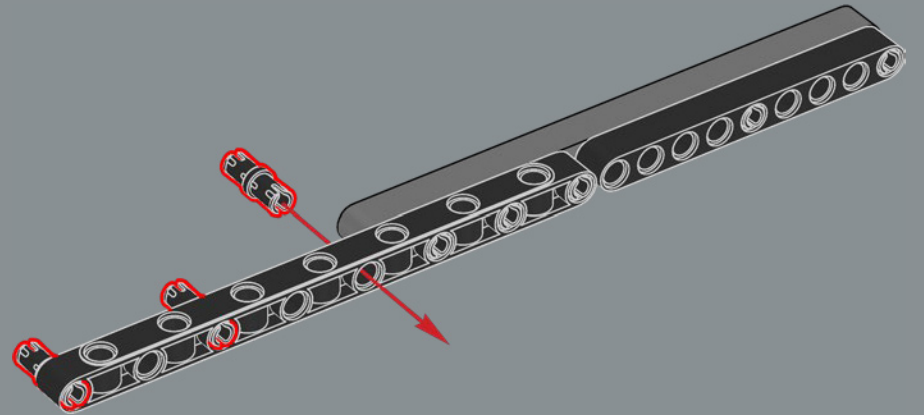

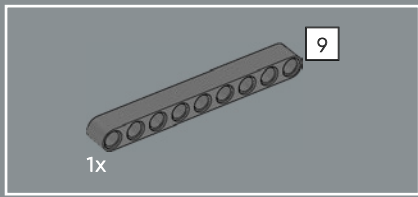

214

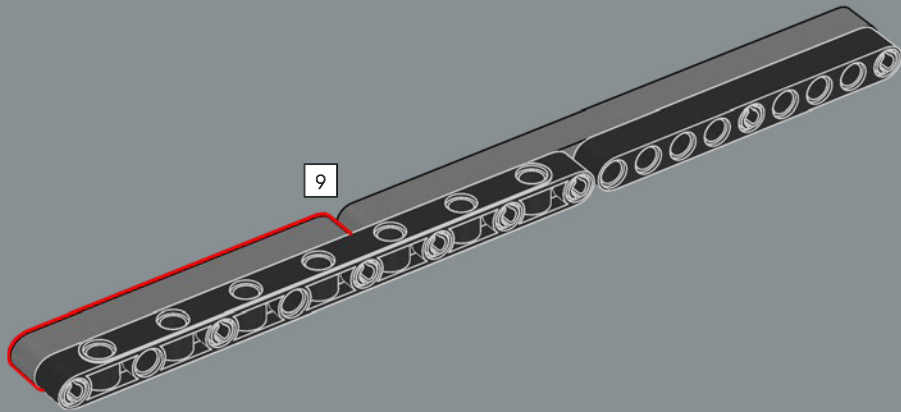

215

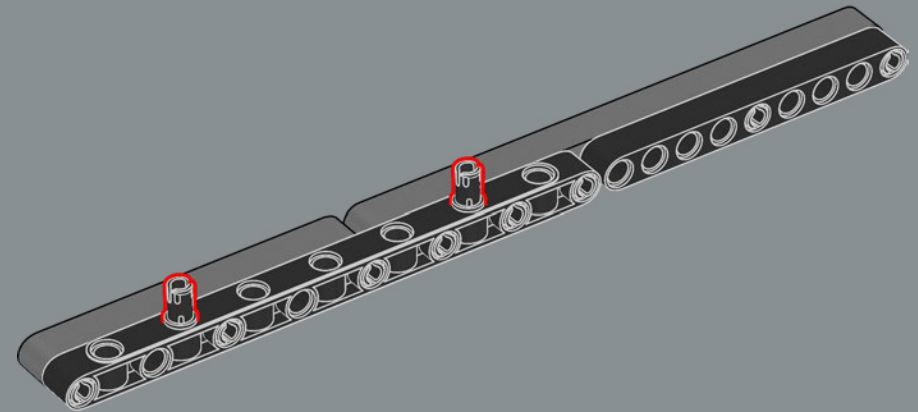

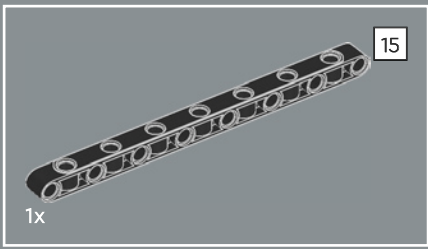

216

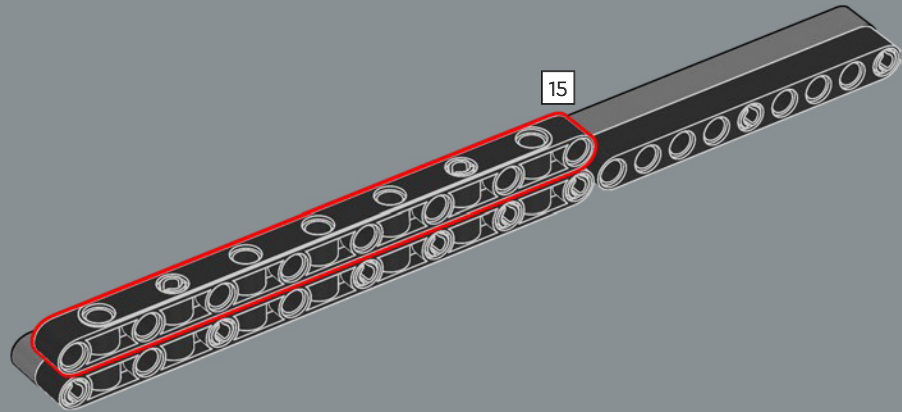

217

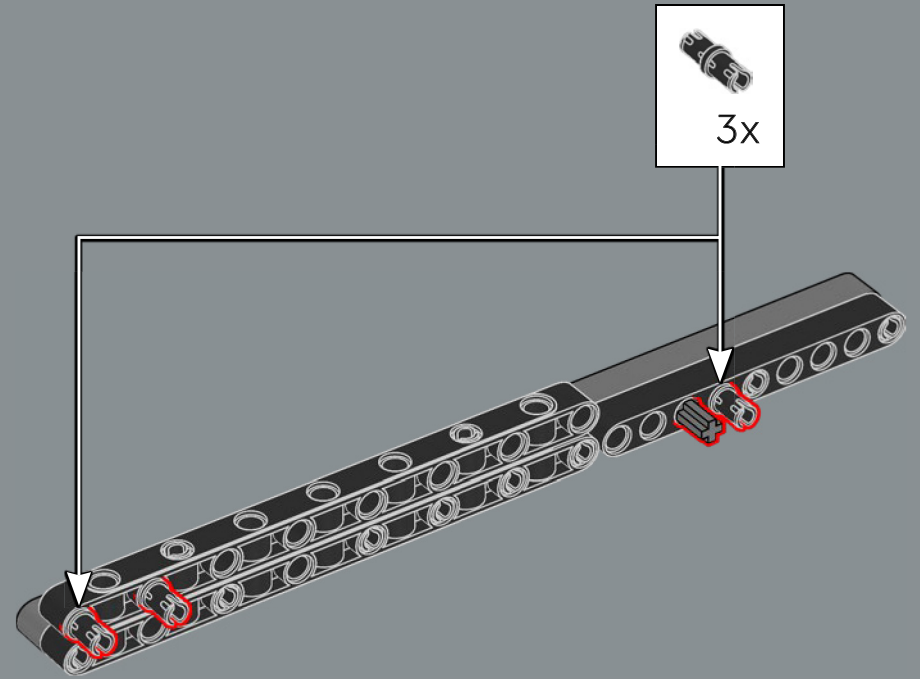

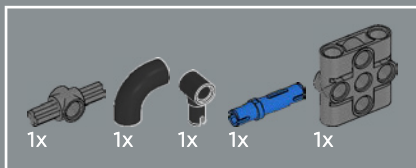

218

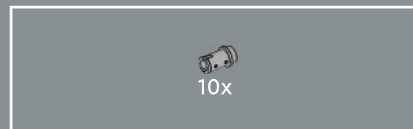
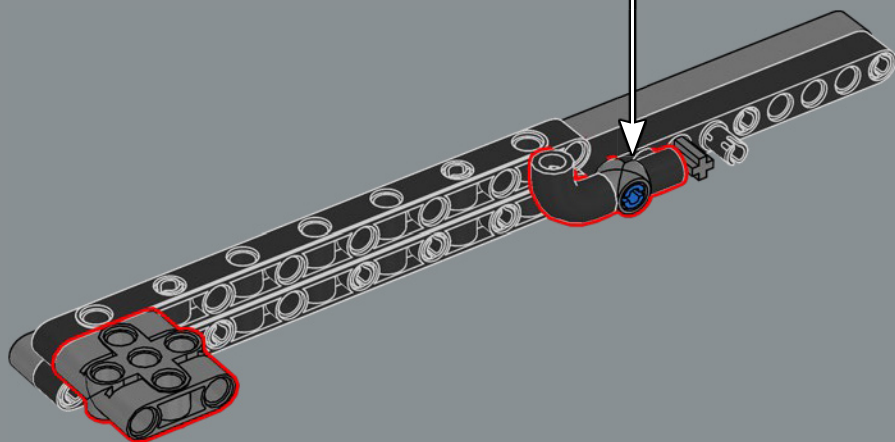
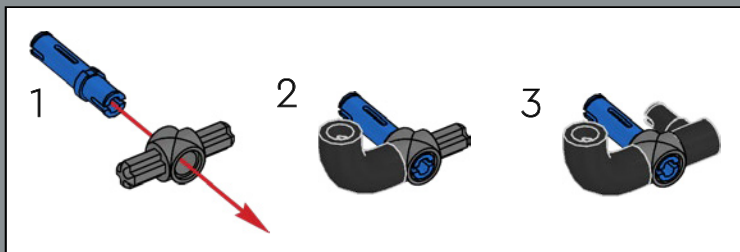

219

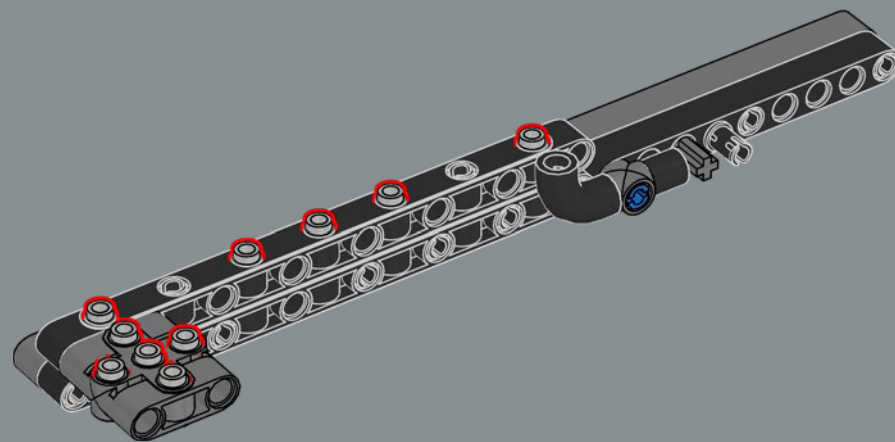

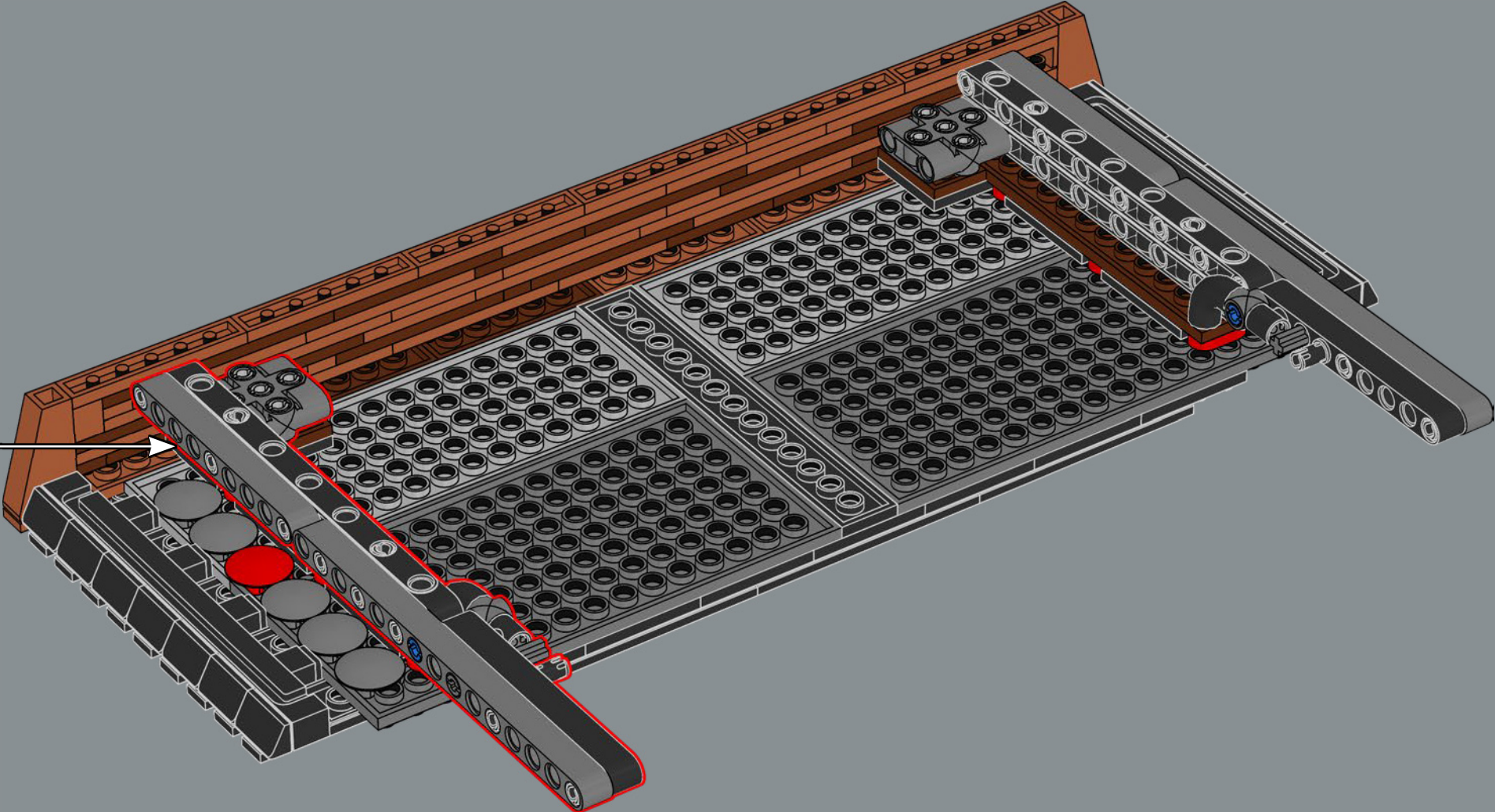

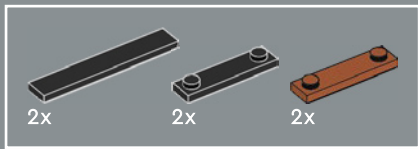

221

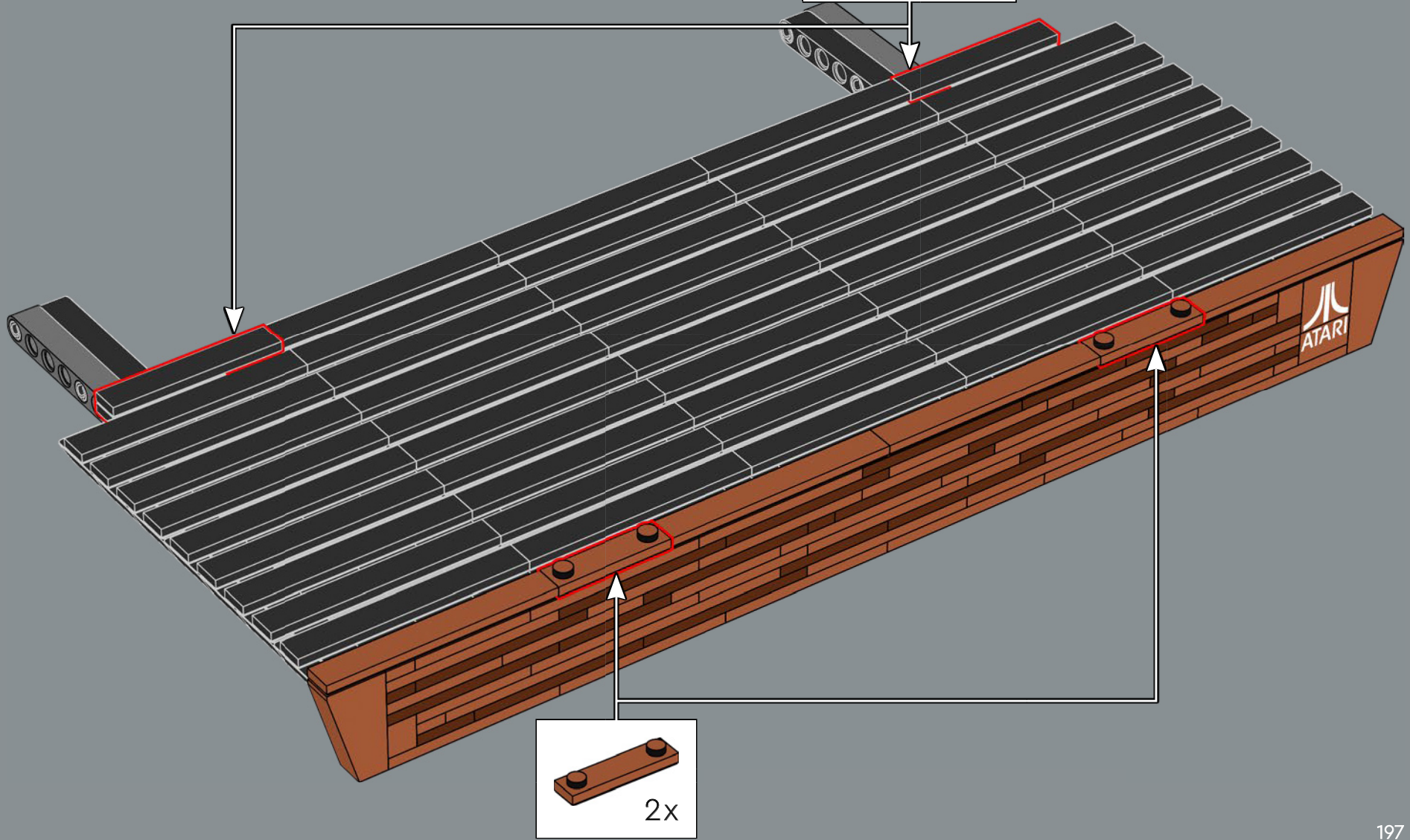
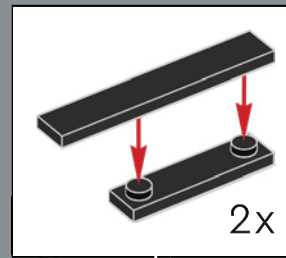

222

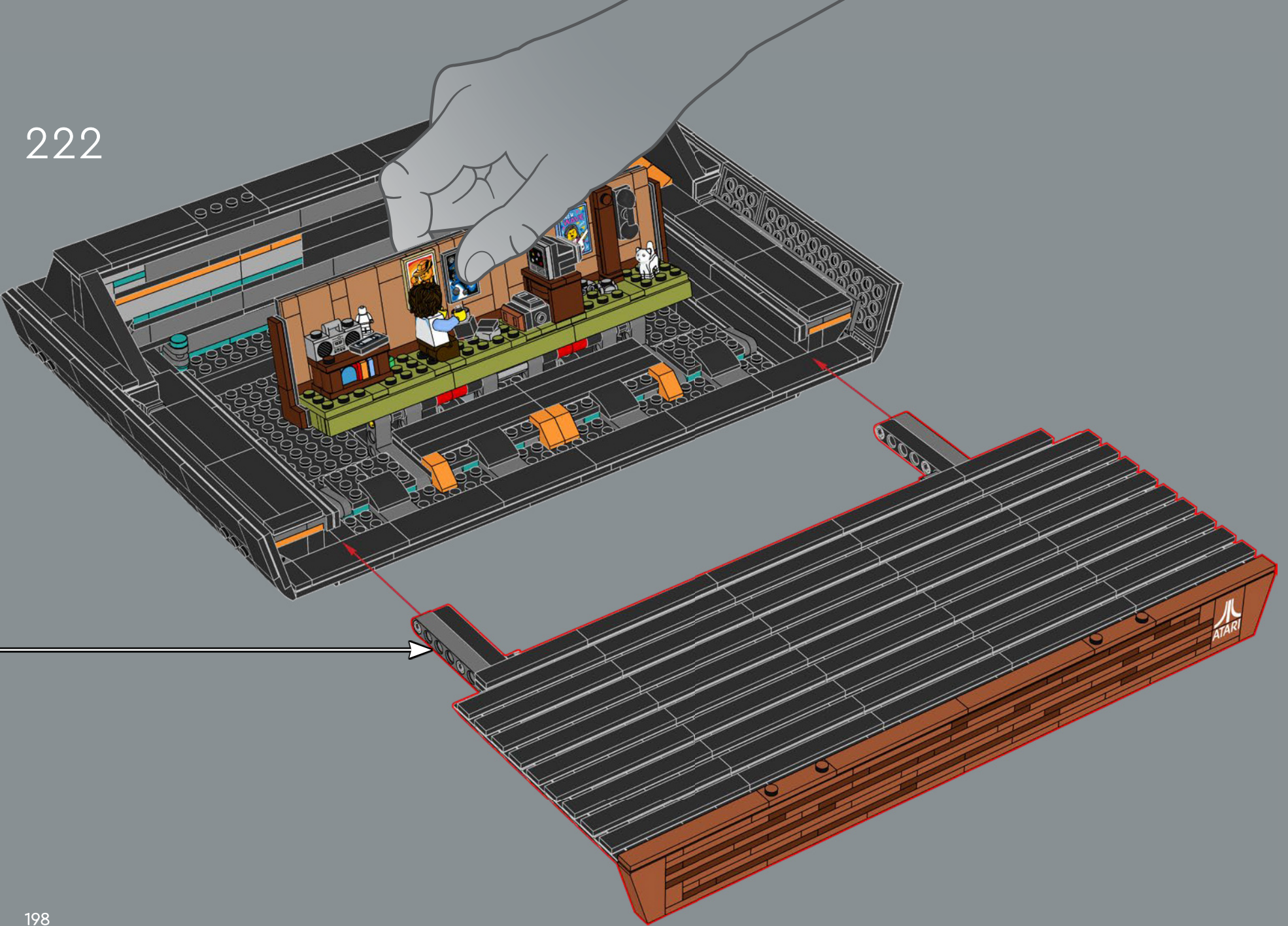

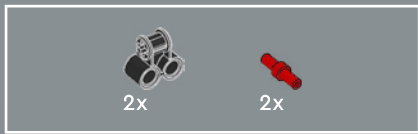

223

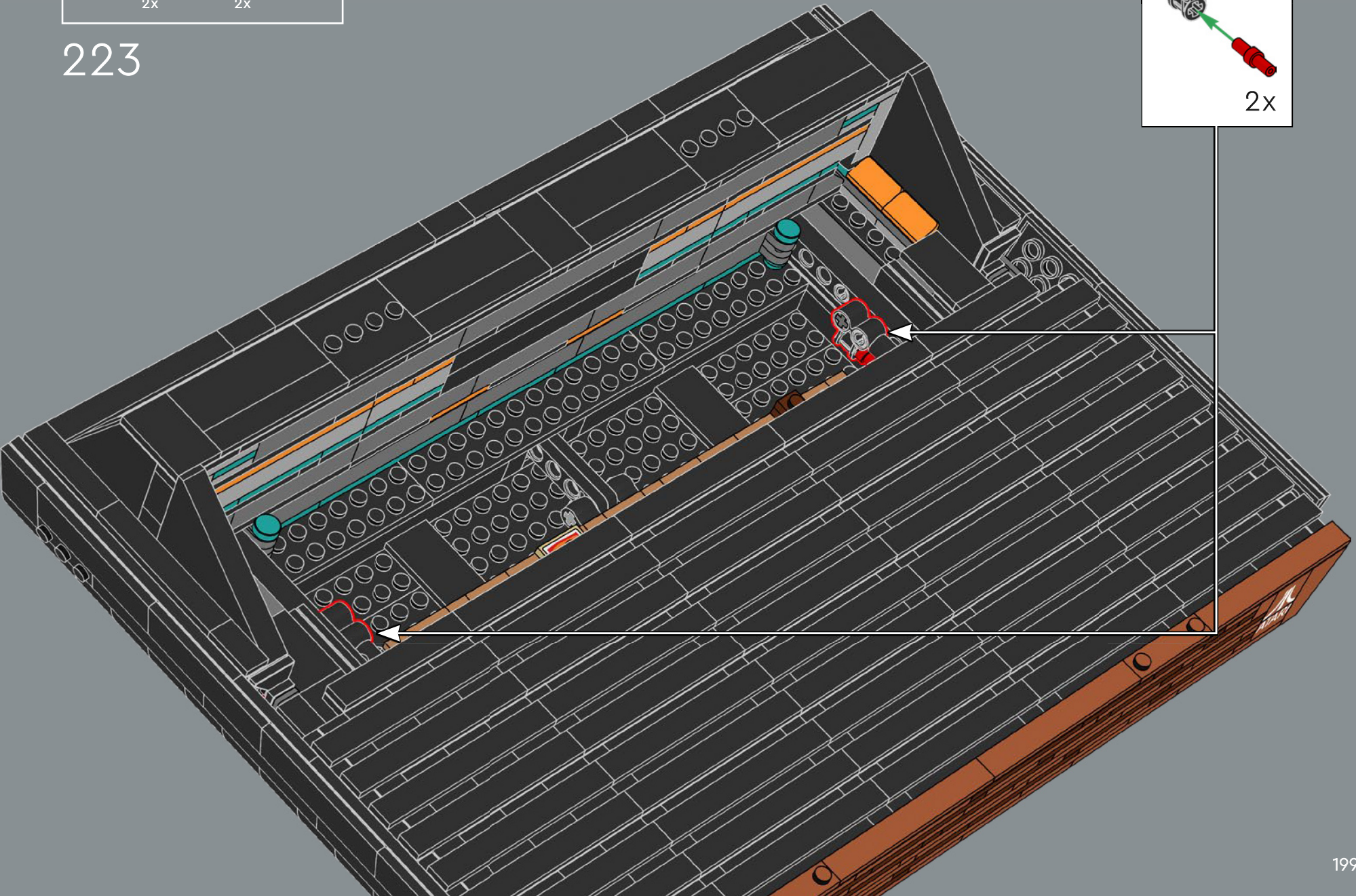
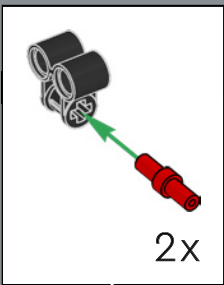





224

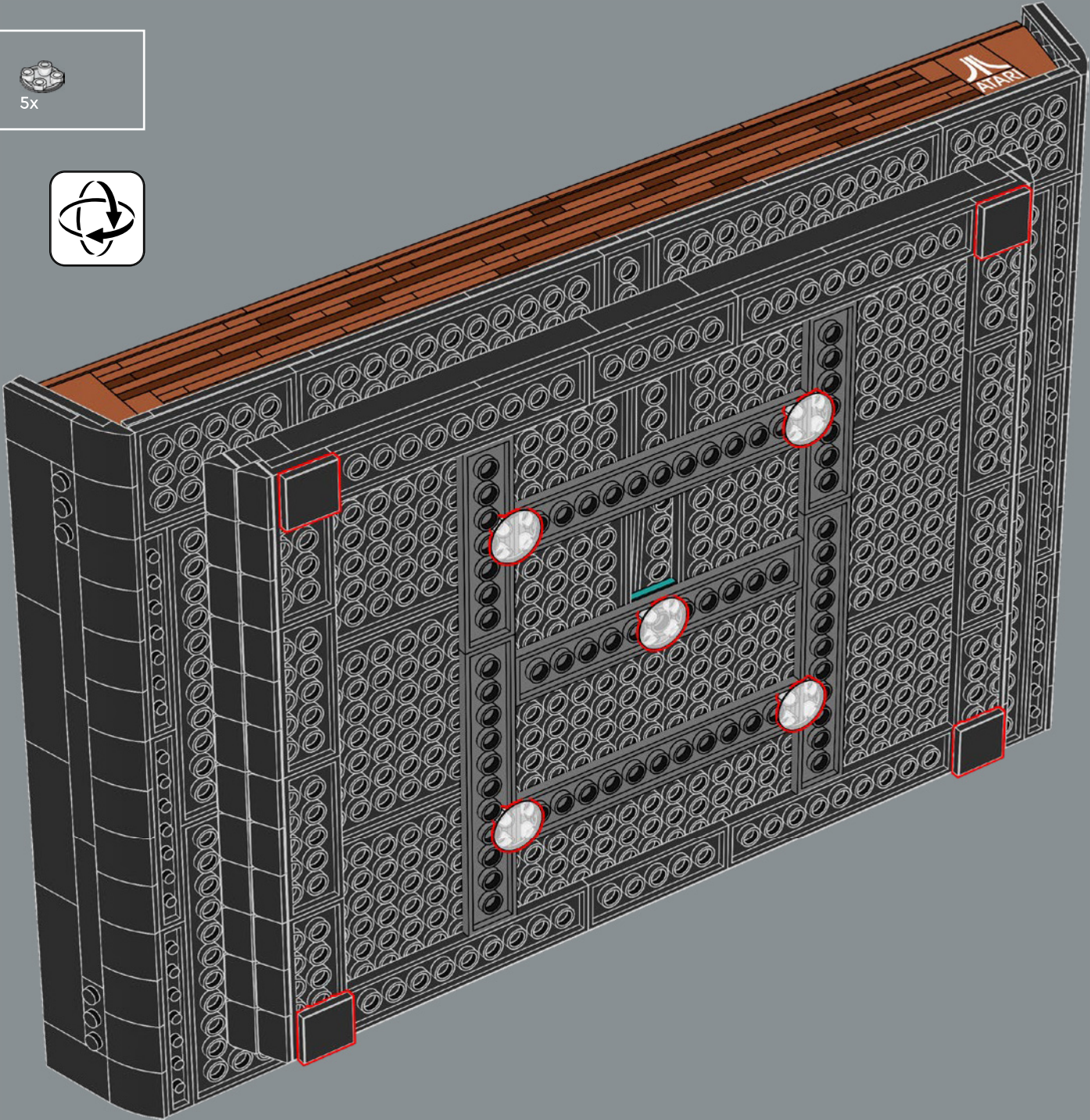

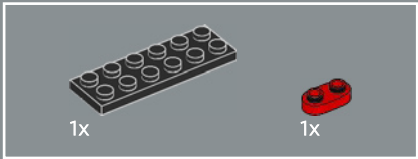
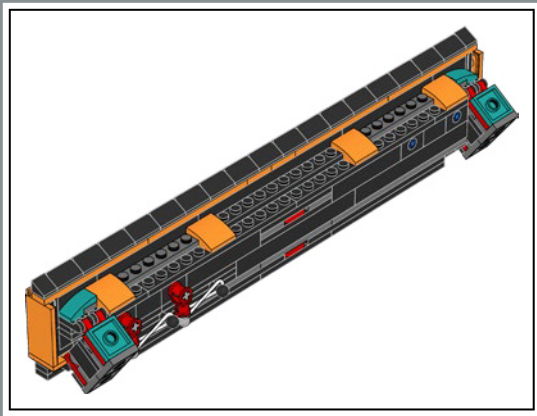

225

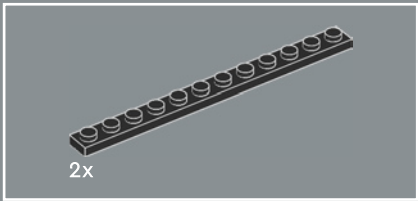
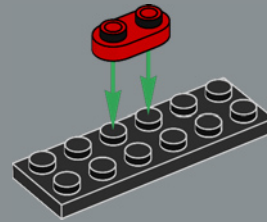

226

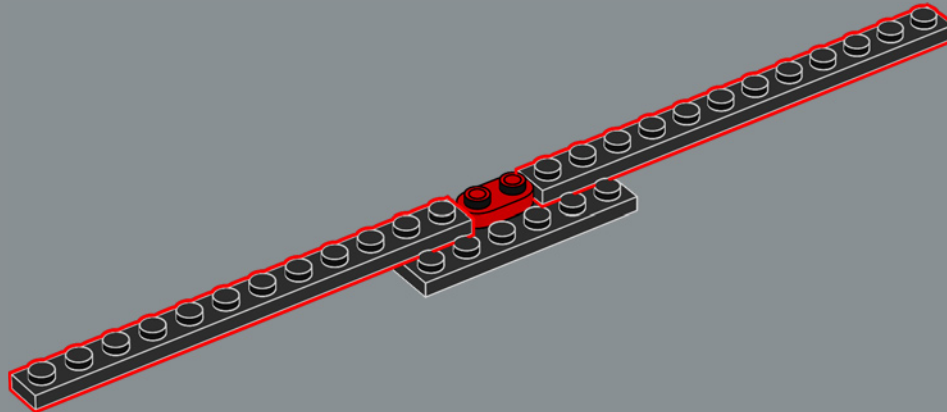

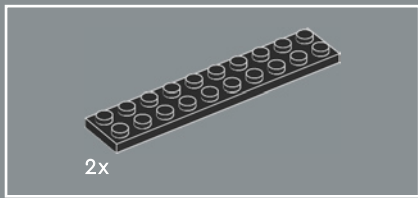

227

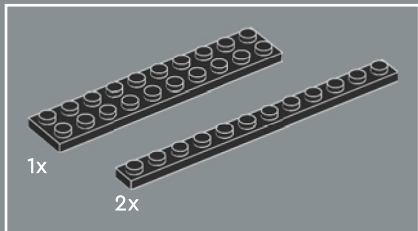
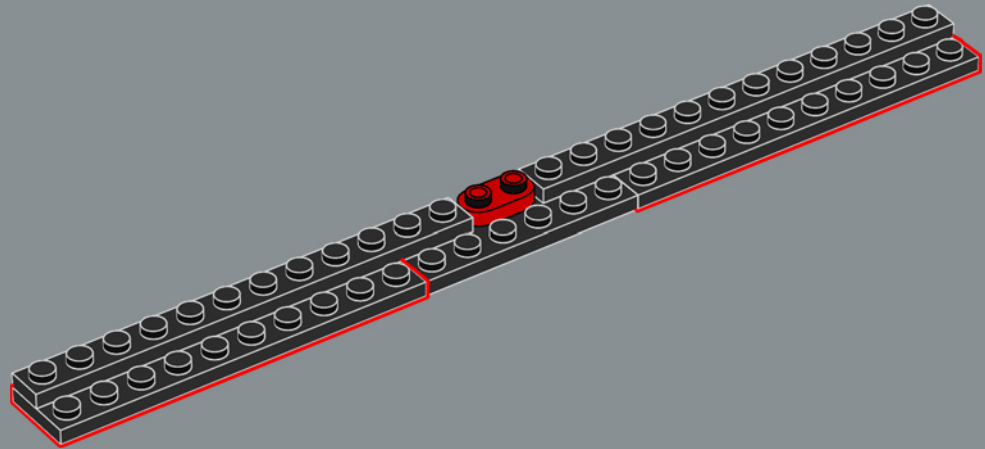

228

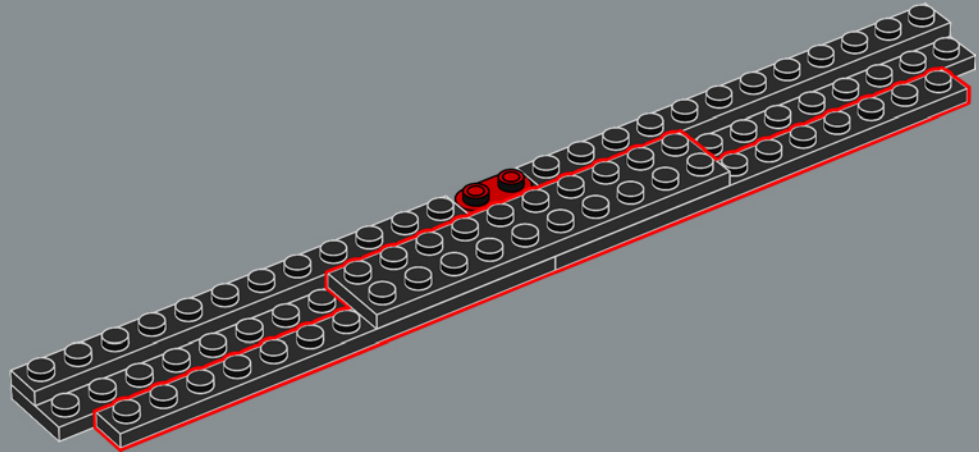

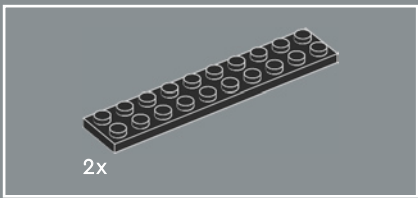

229

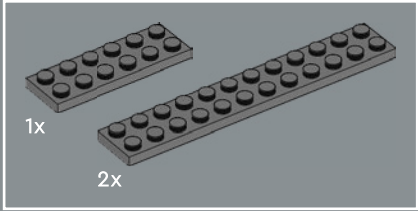
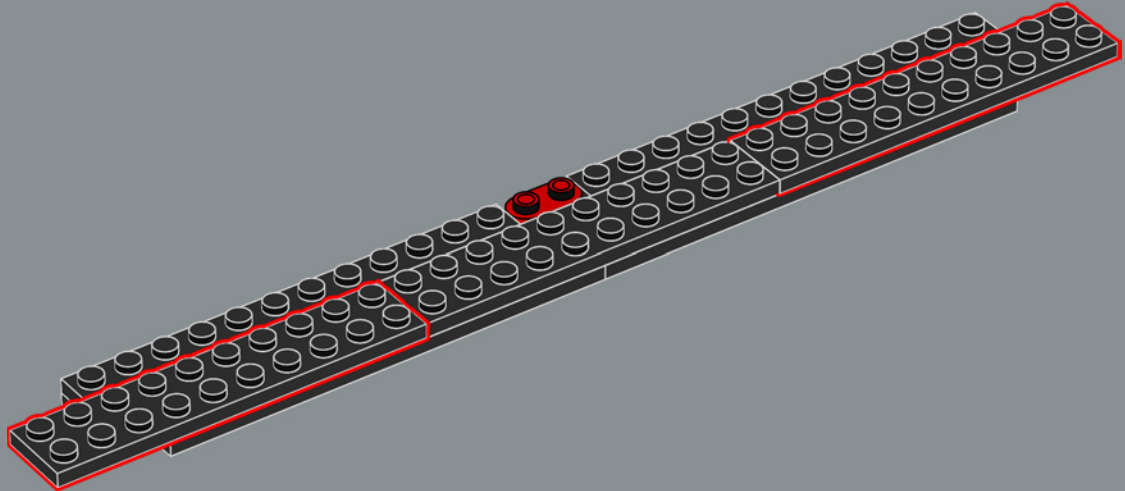

230

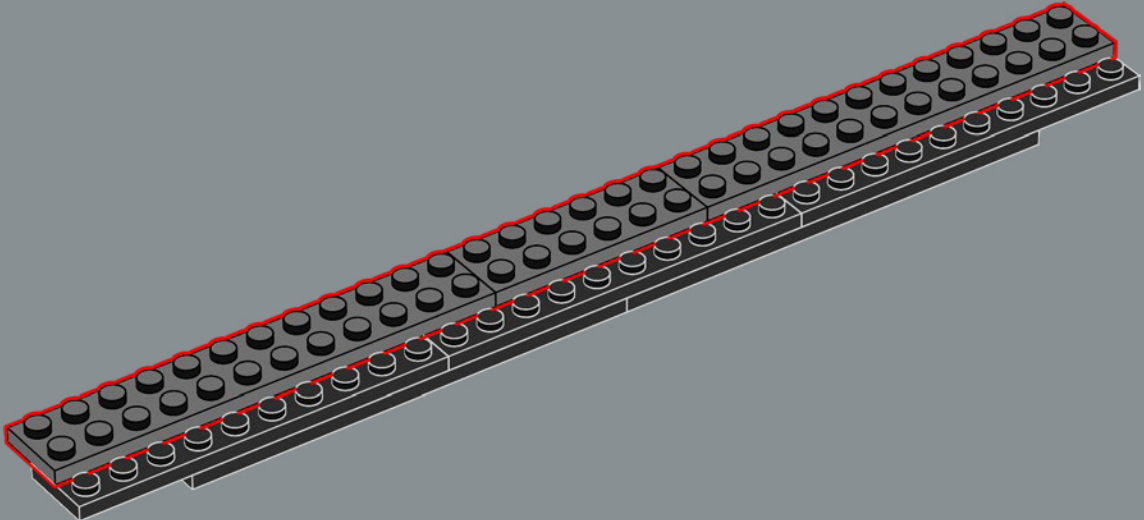

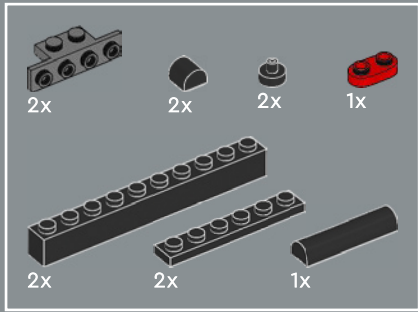

231

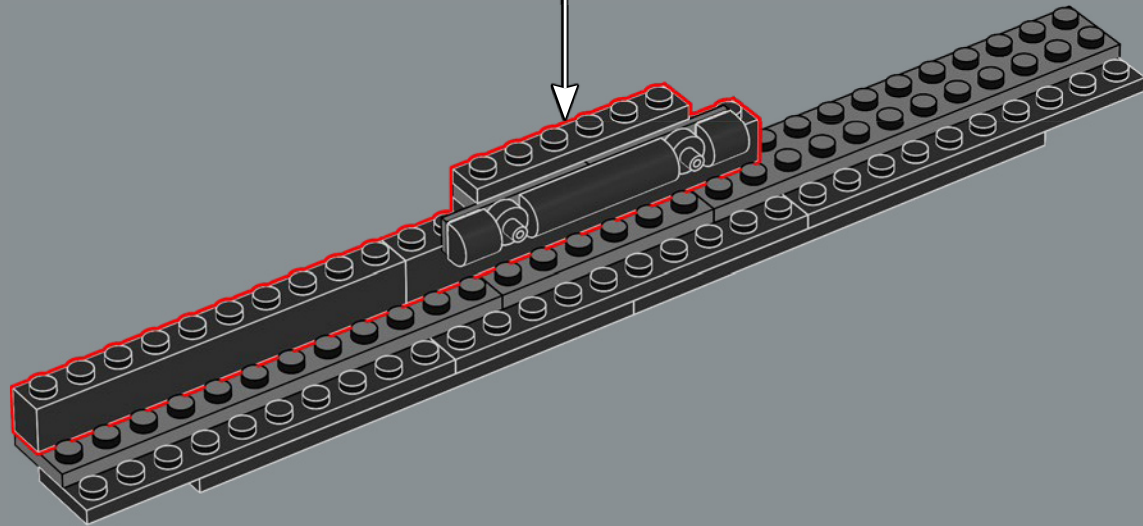
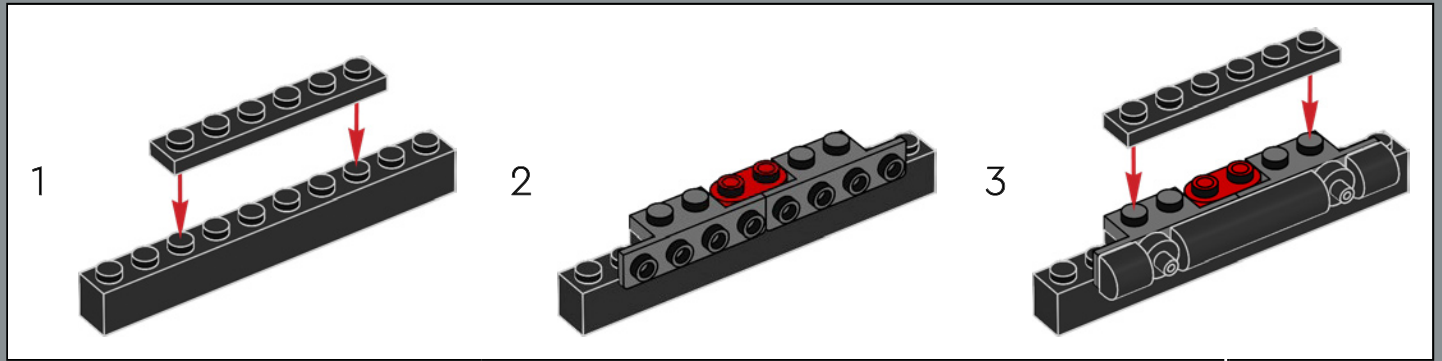

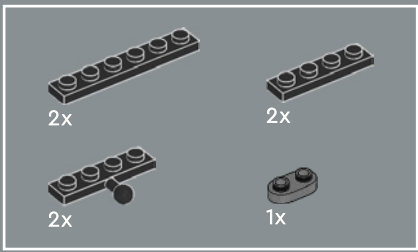

232

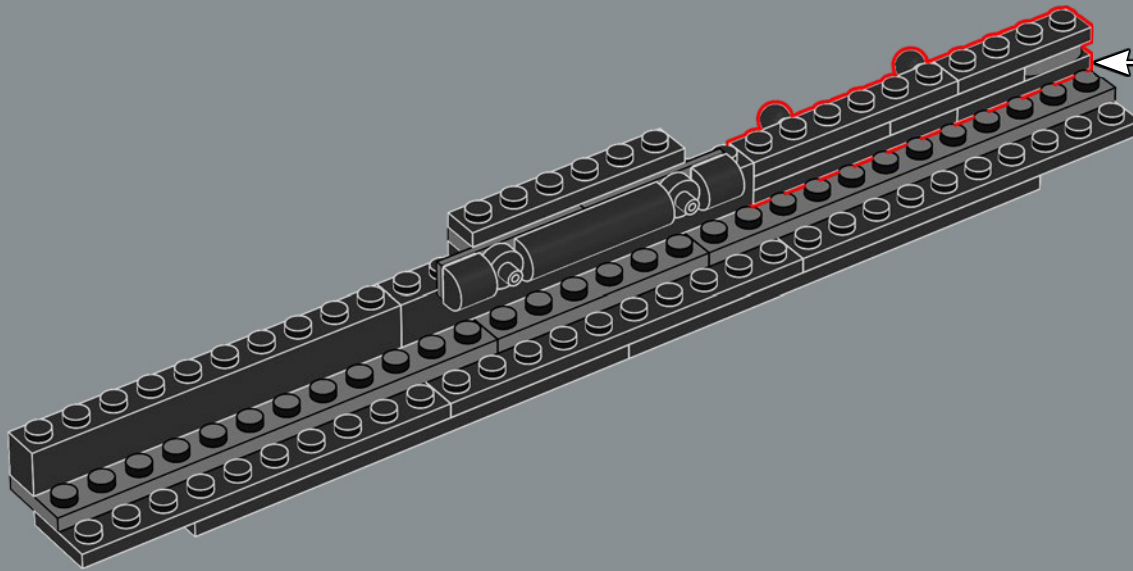
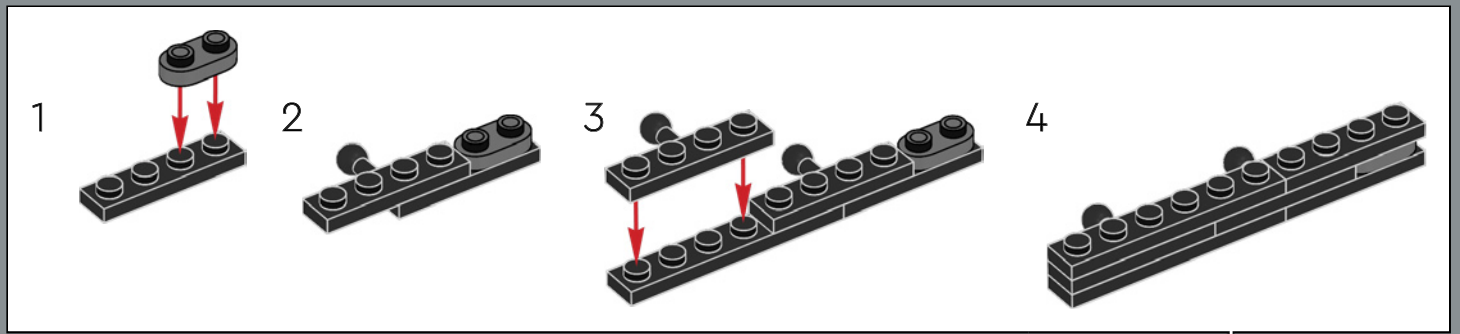

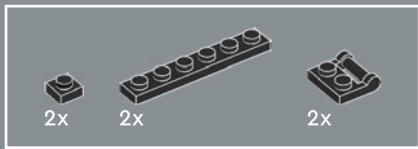

233

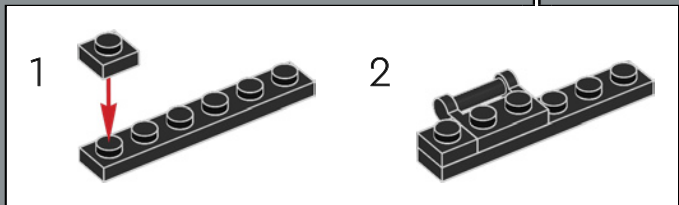
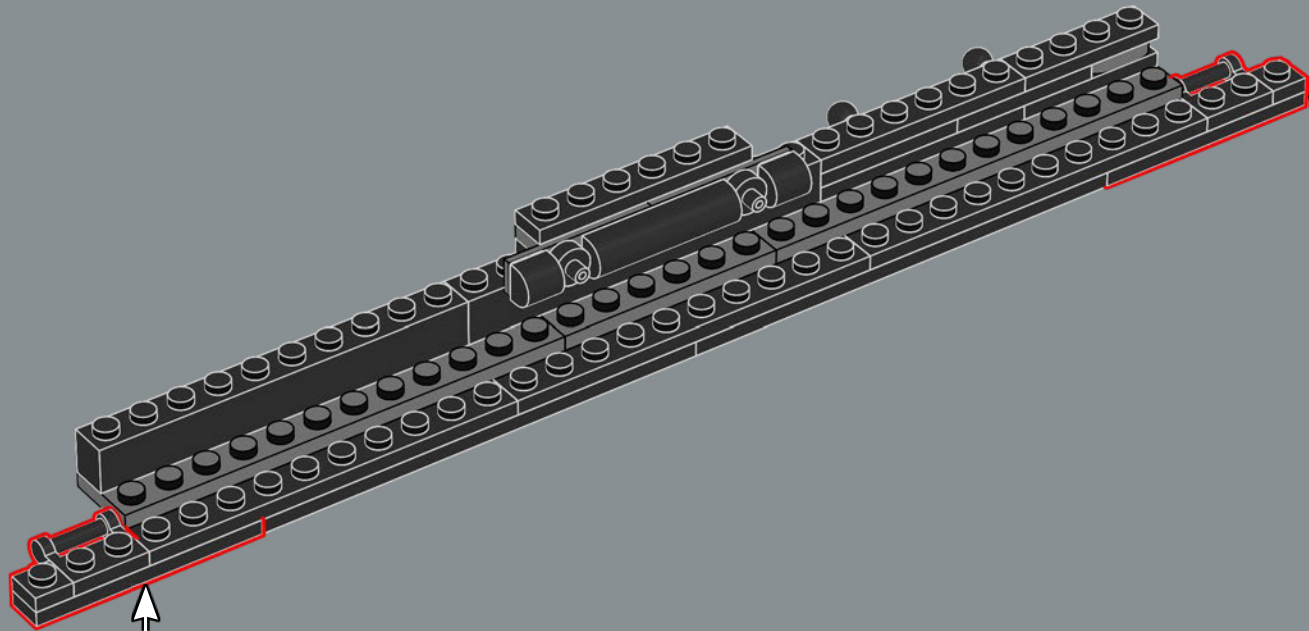
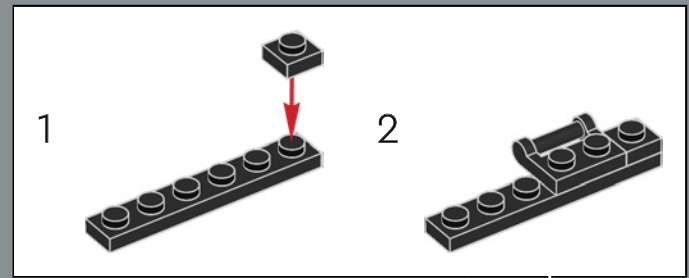

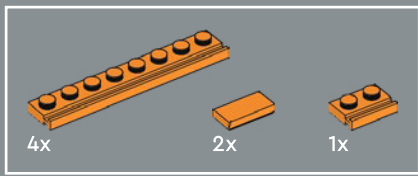

234

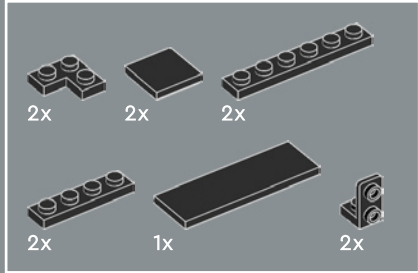
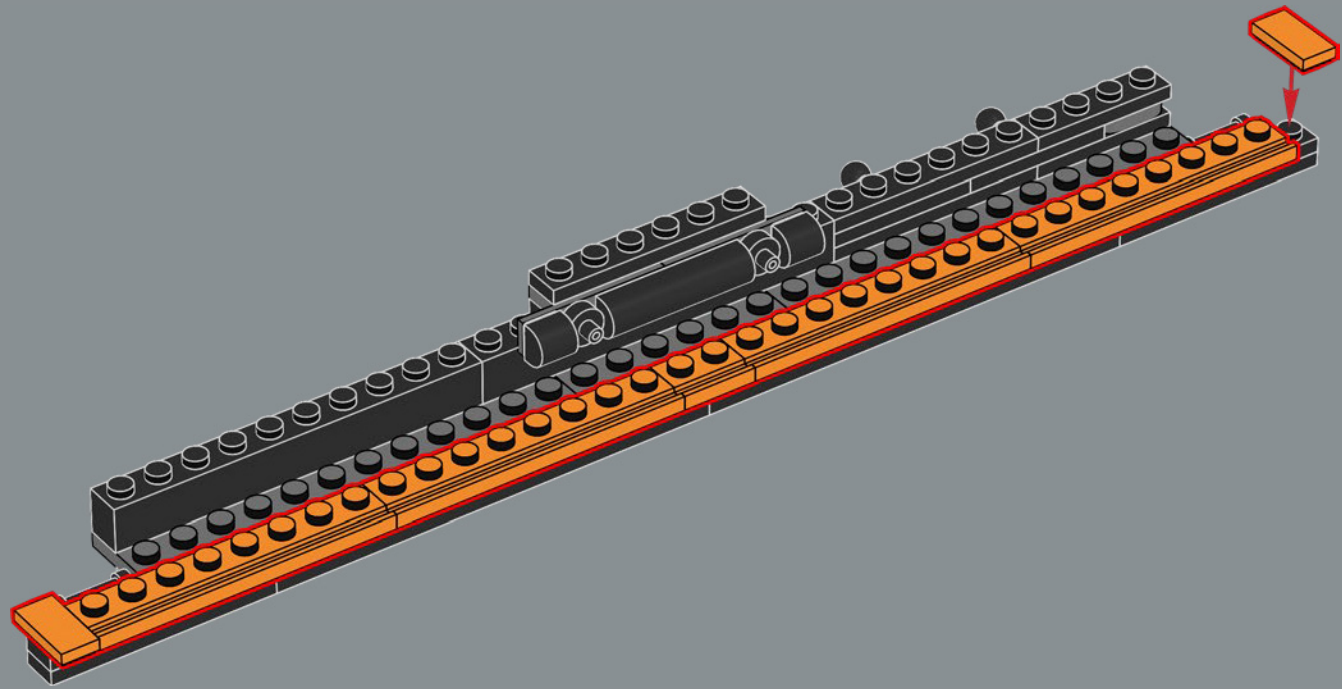

235

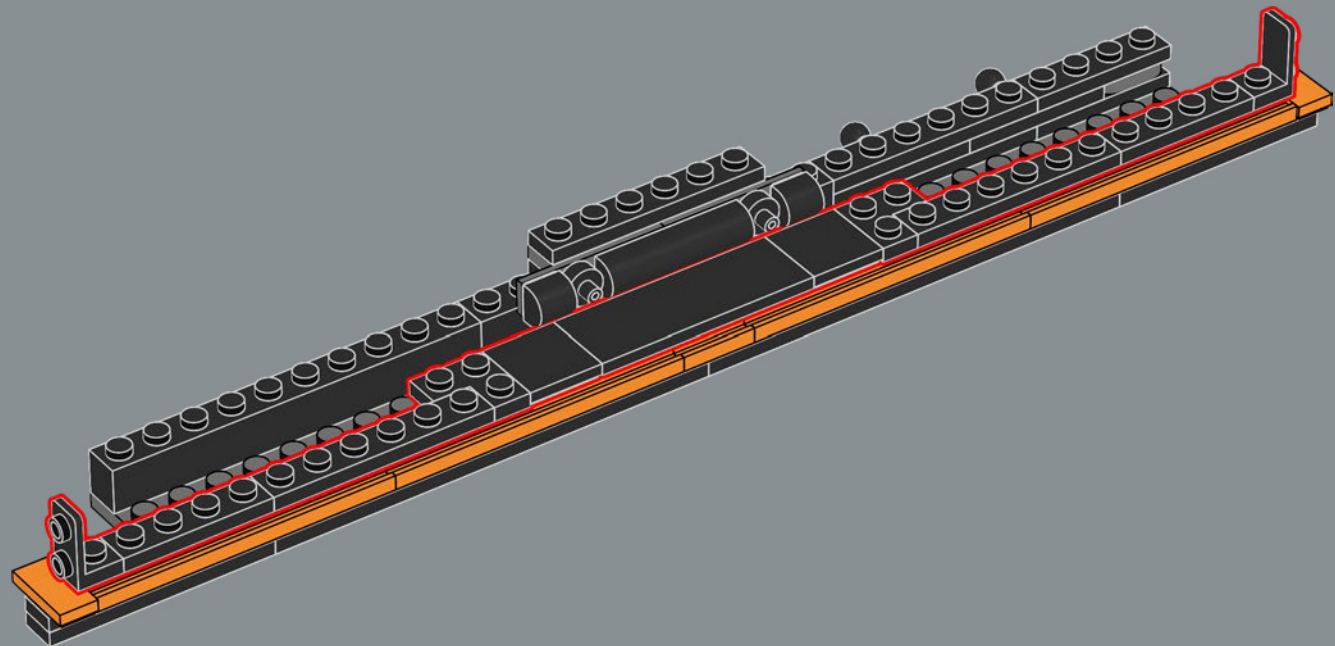

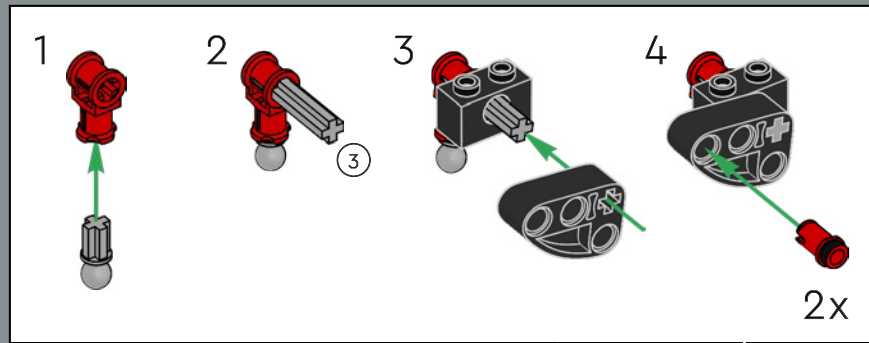
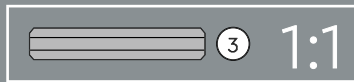
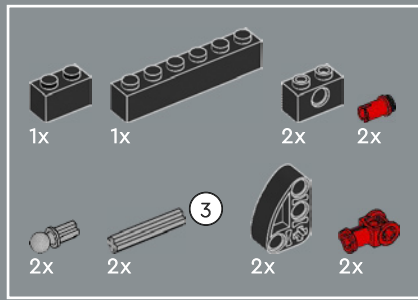

236

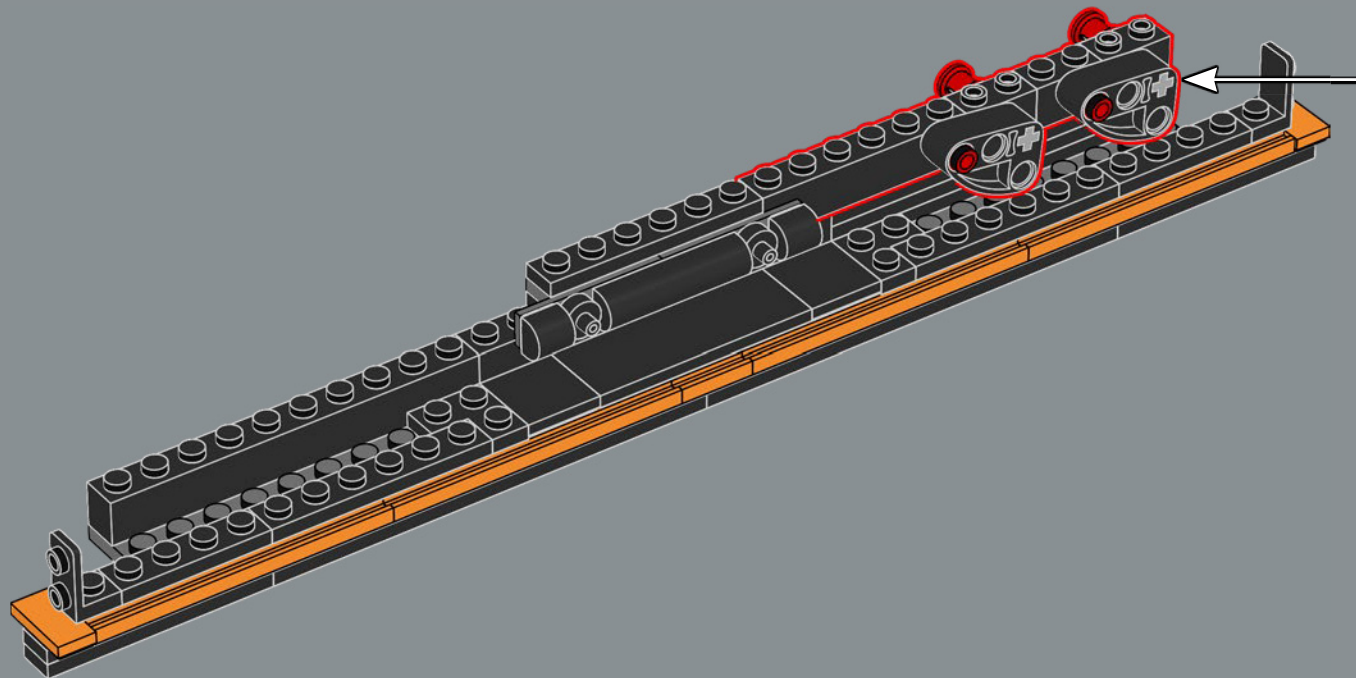

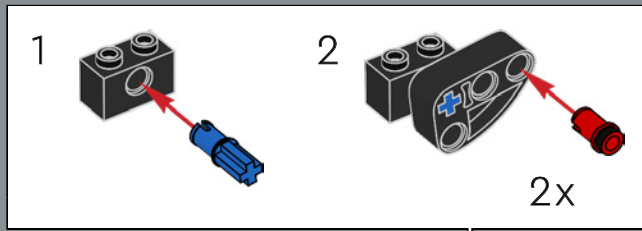
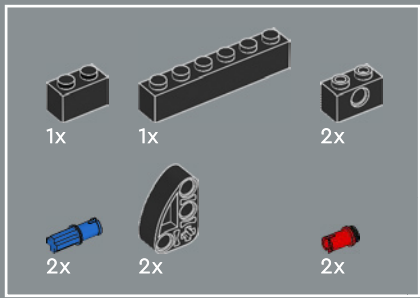

237

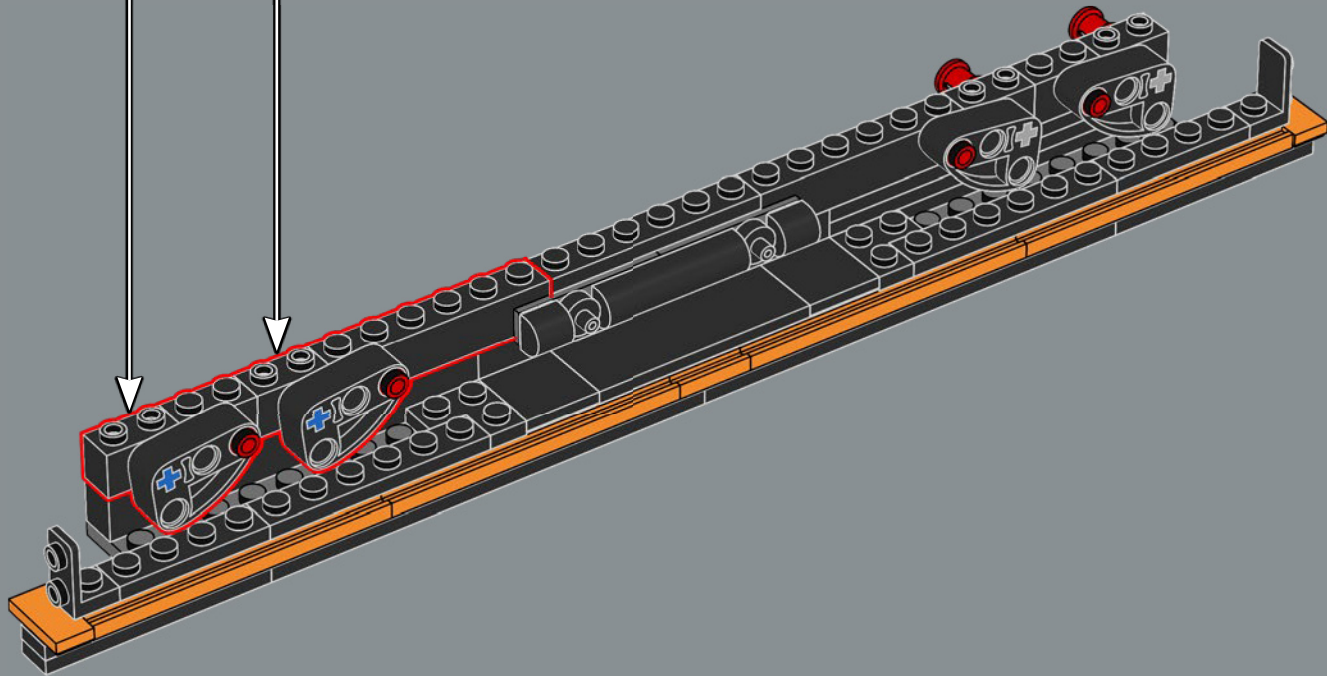

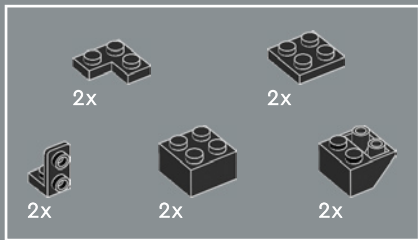

238

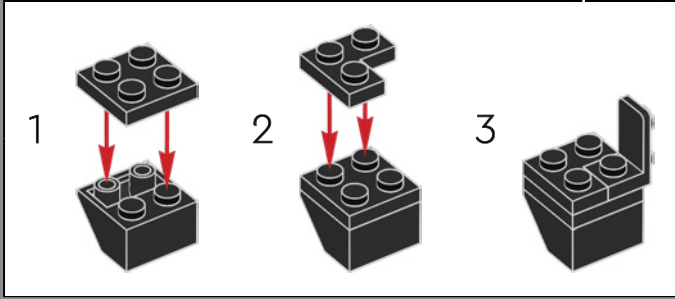
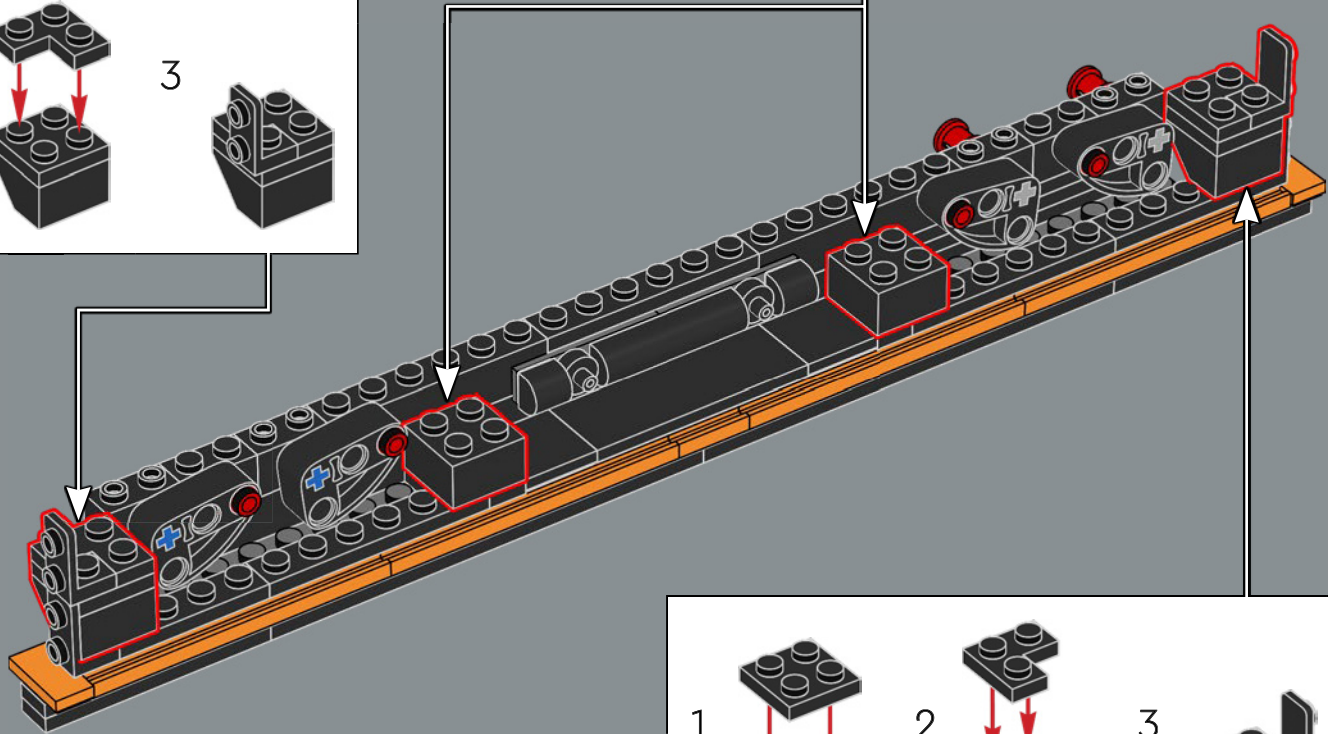
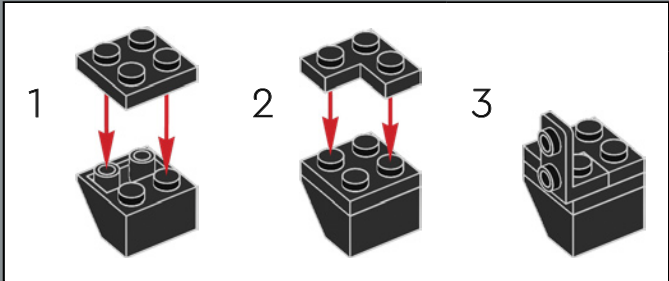
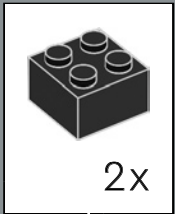

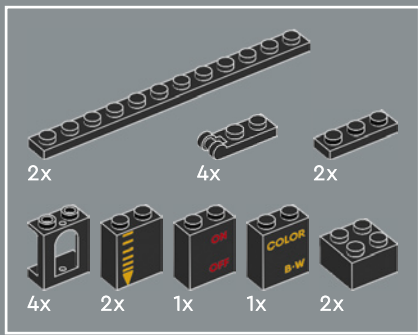

239

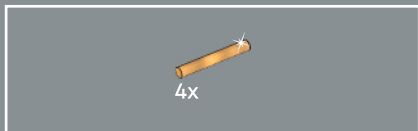
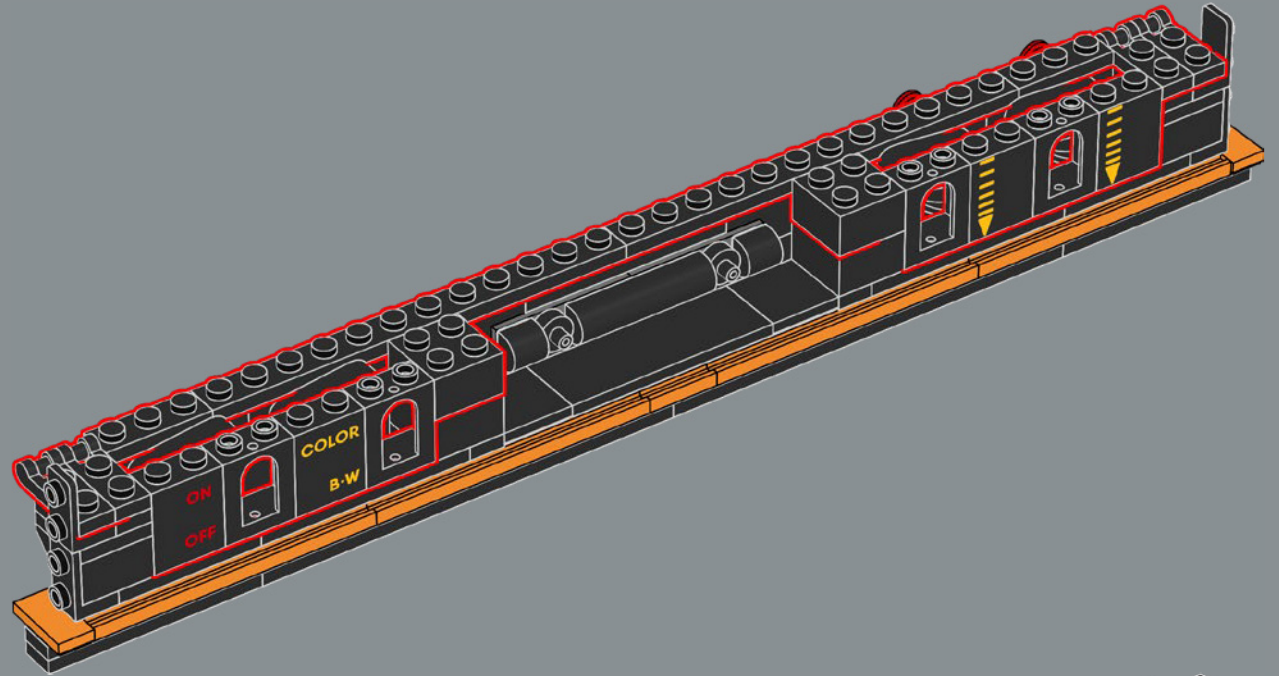

240

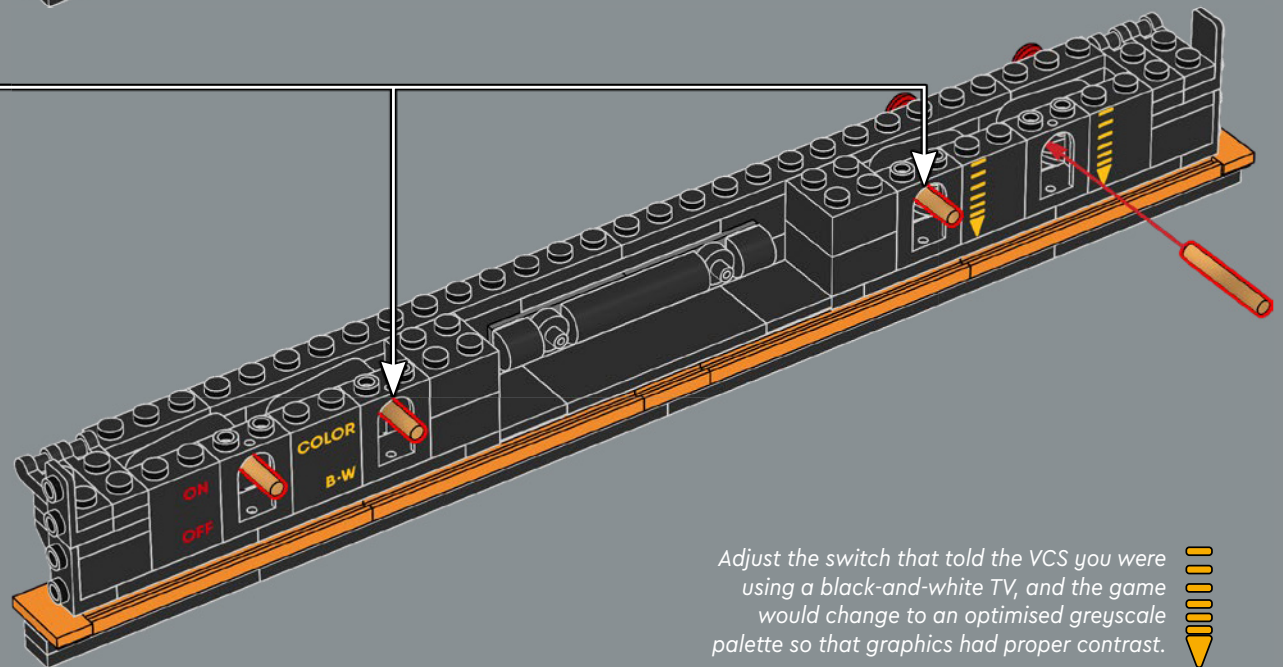
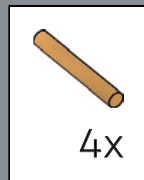

Adjust the switch that told the VCS you were using a black-and-white TV, and the game would change to an optimised greyscale palette so that graphics had proper contrast.



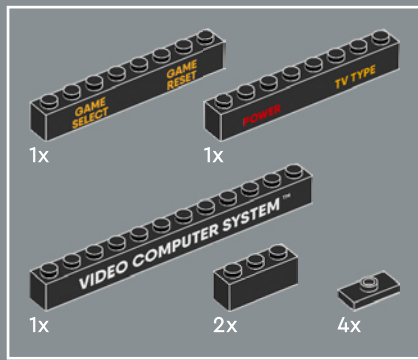

241

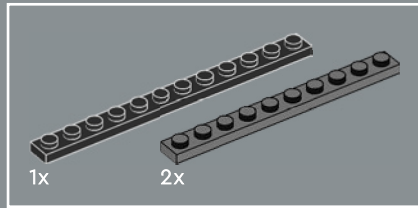
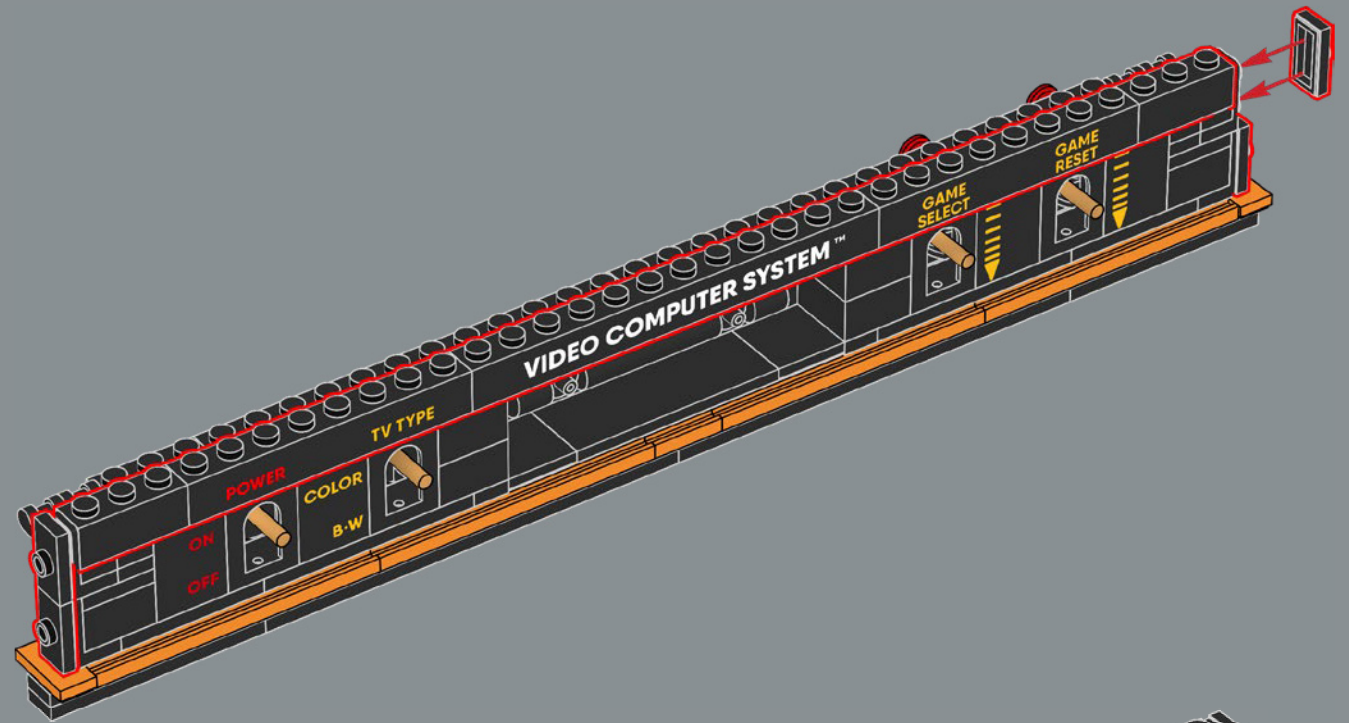

242

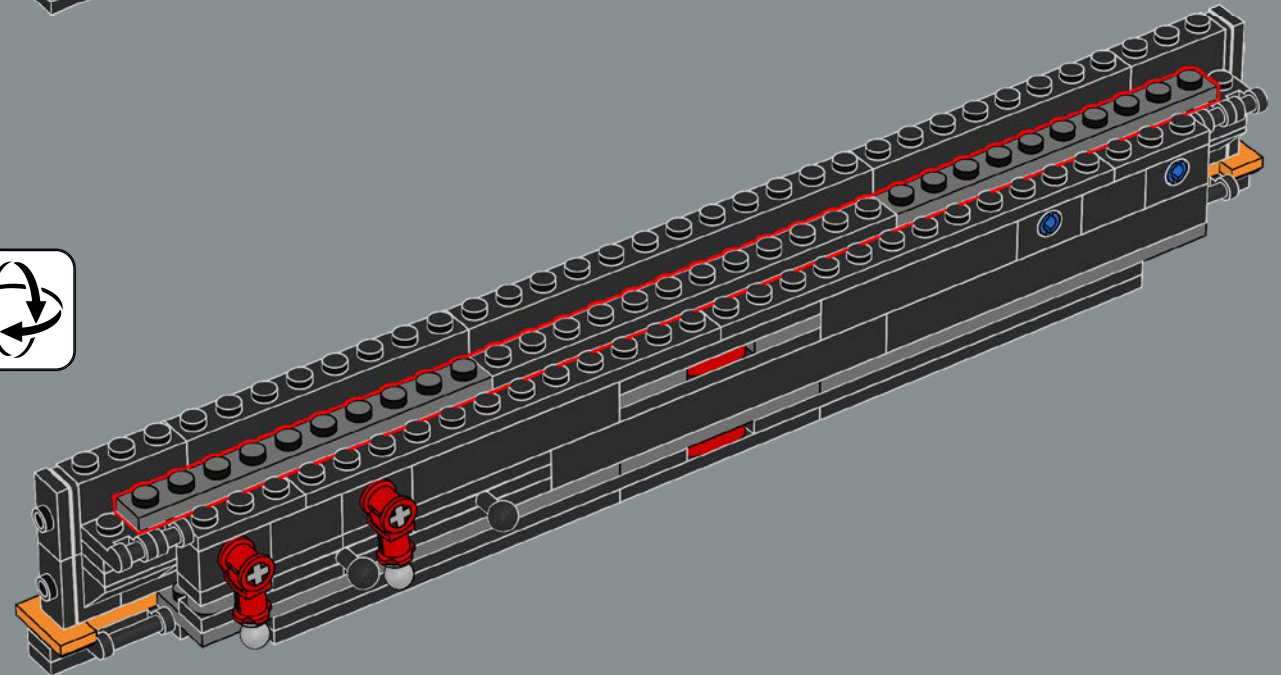

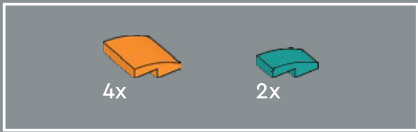

243

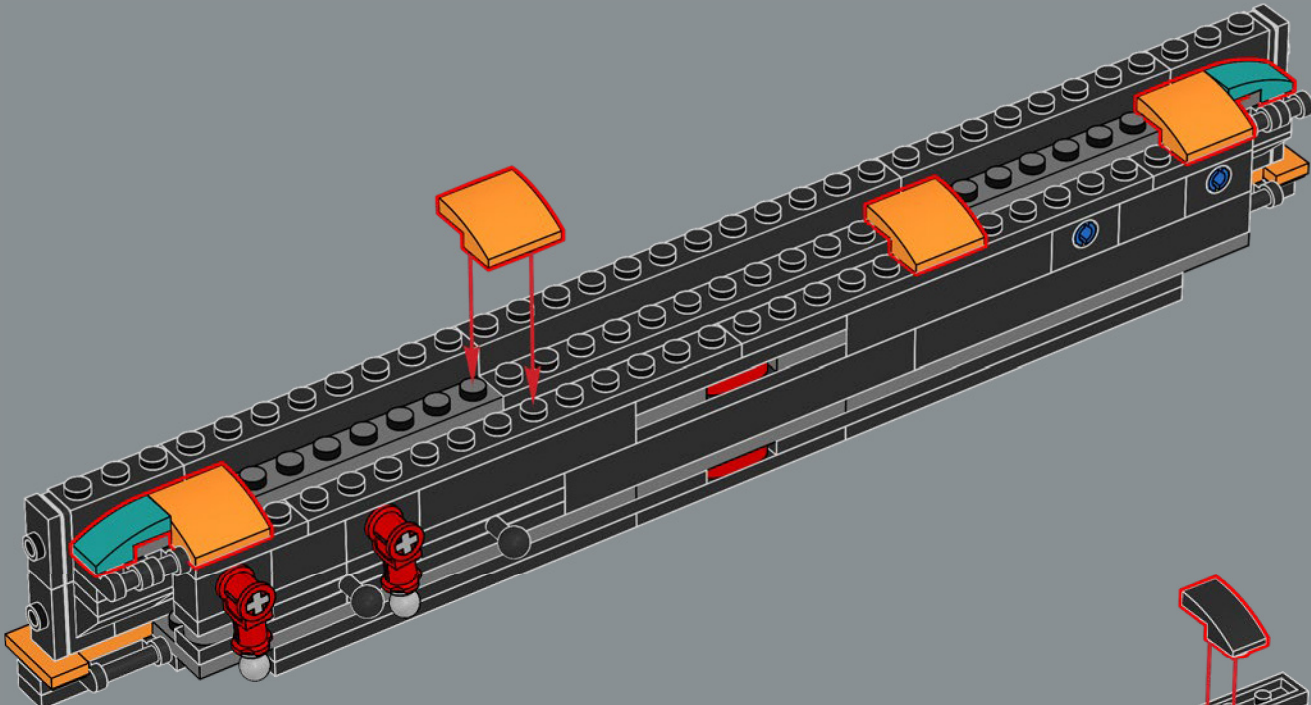

244



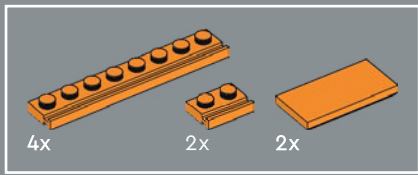

245

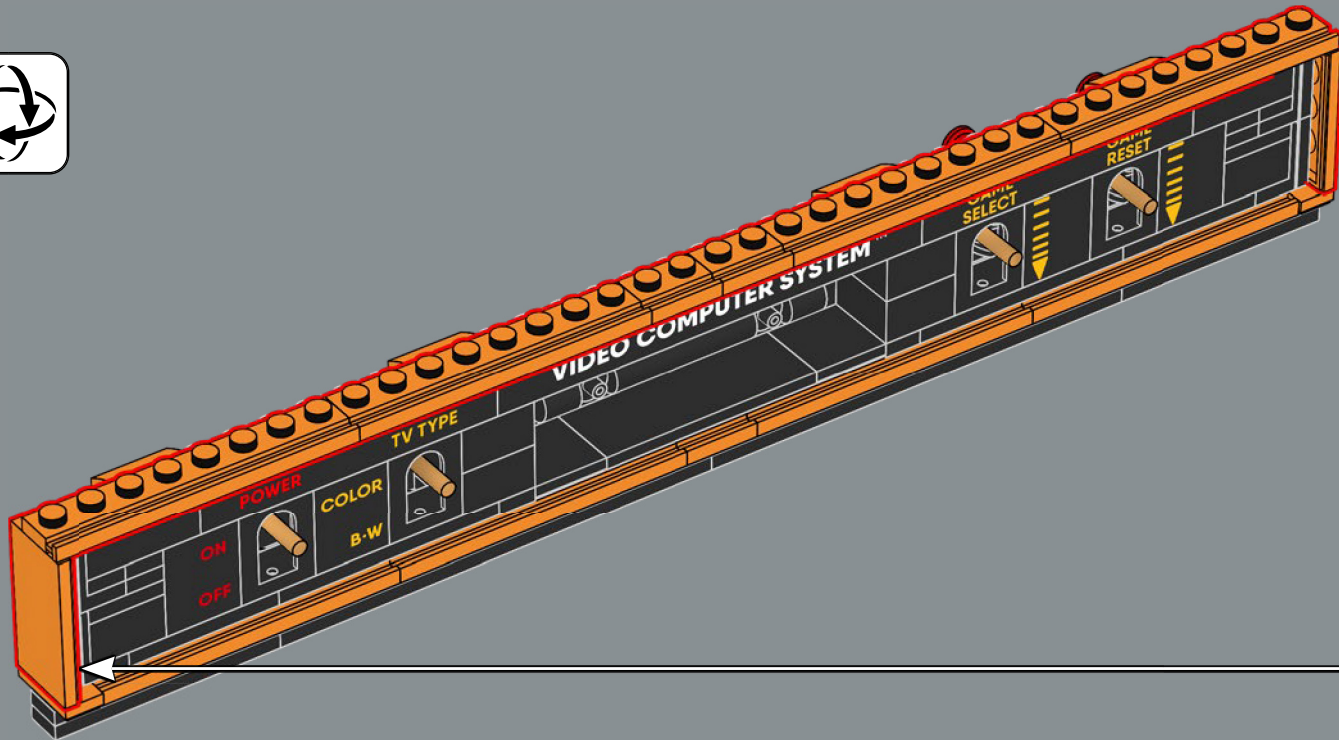
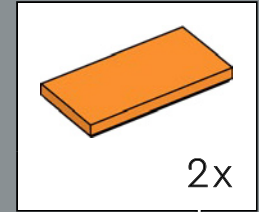



246

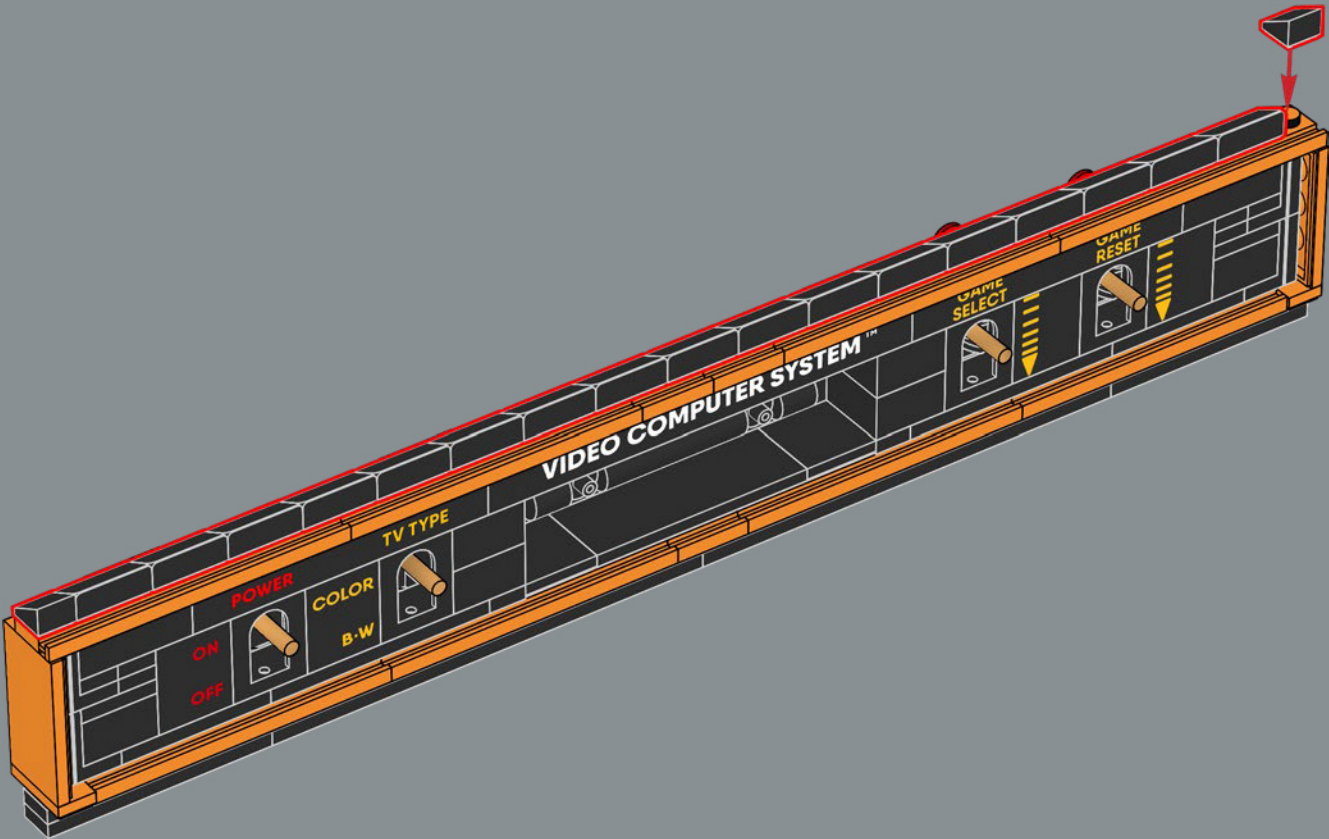



247

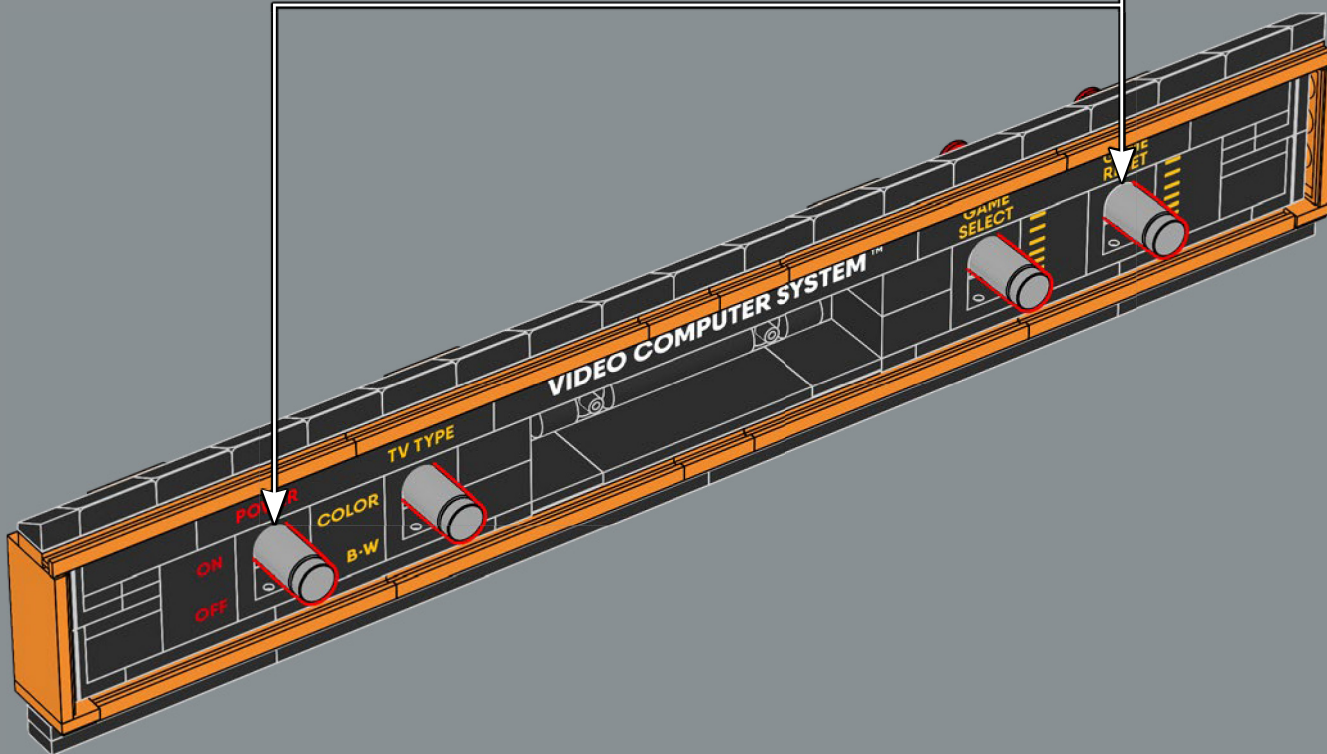
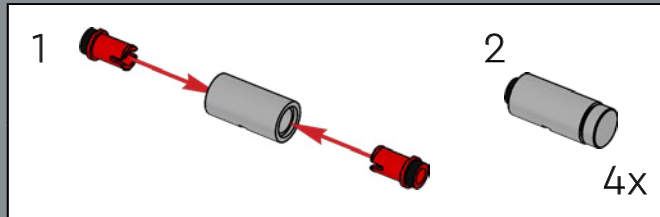



2x



2x



2x



2x



4x



2x



4x



4x



4x

248

1

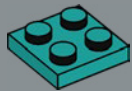

2

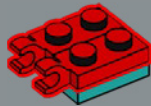

3

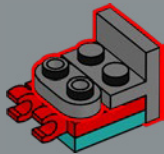

4

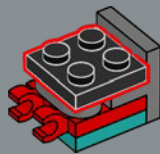

5

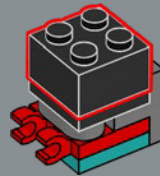

6

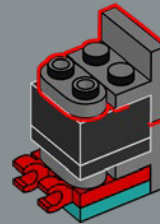

7

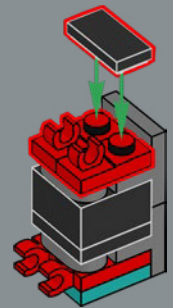

2x

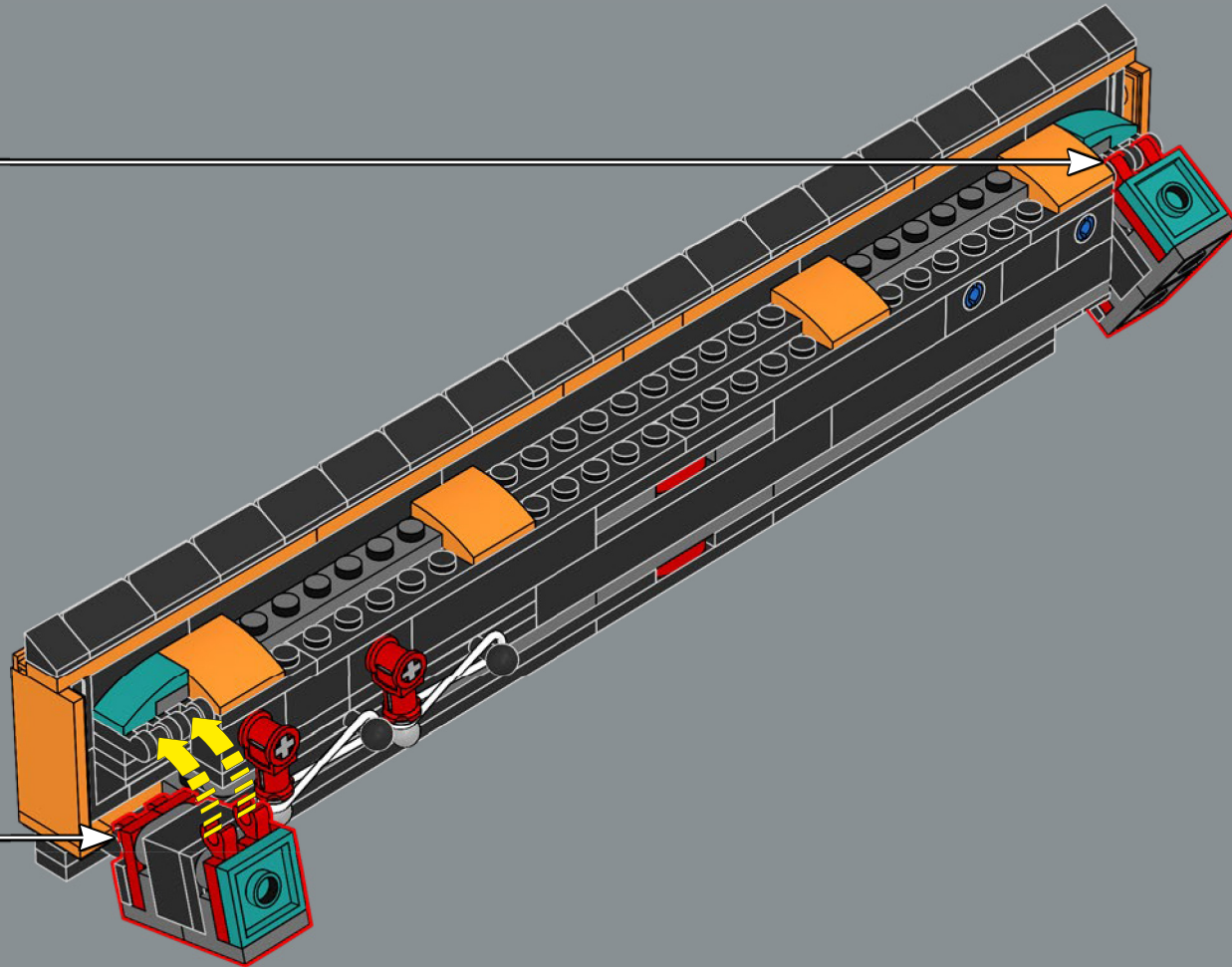

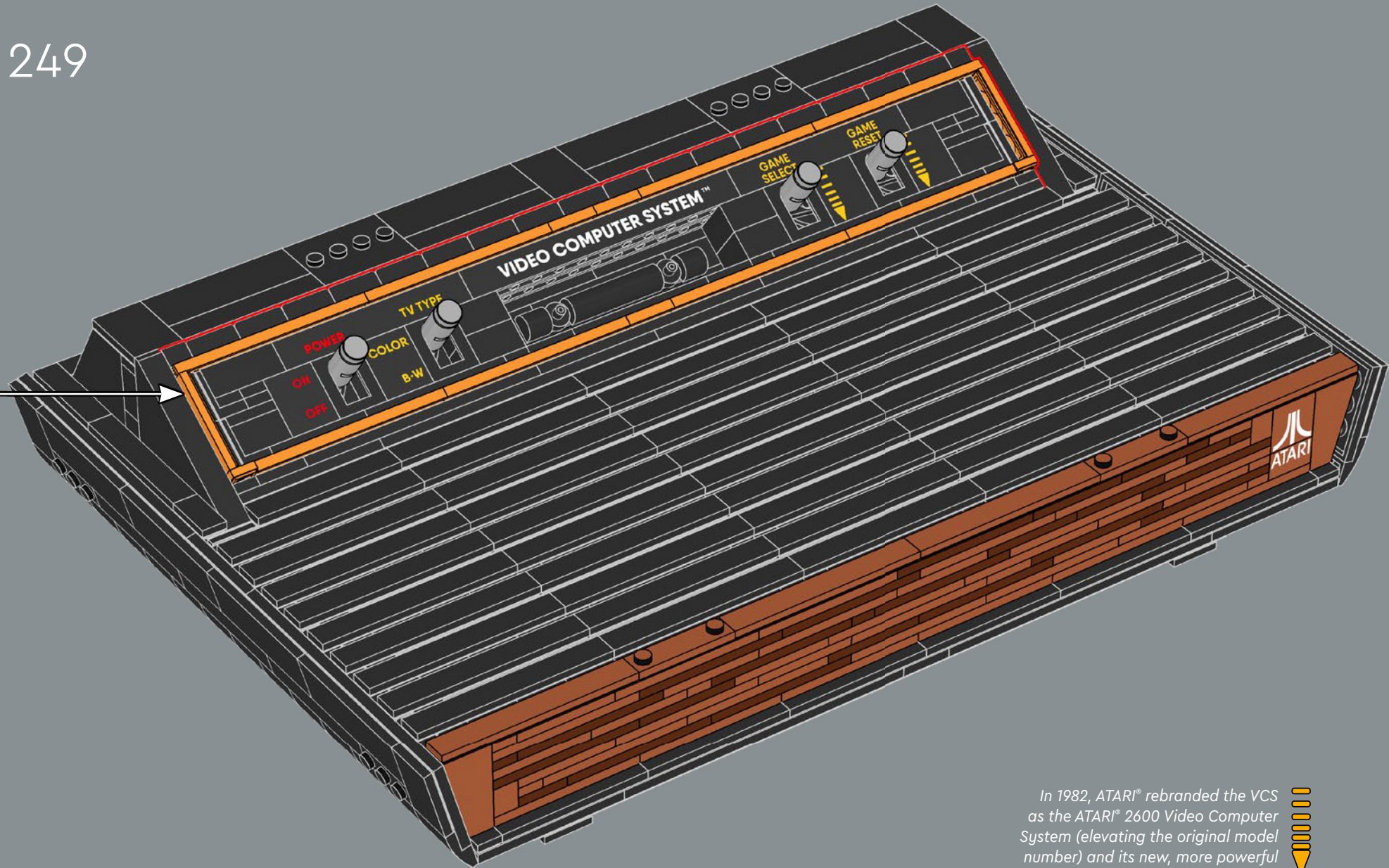

In 1982, ATARI® rebranded the VCS as the ATARI® 2600 Video Computer System (elevating the original model number) and its new, more powerful sibling was introduced as the ATARI® 5200 Video Computer System.



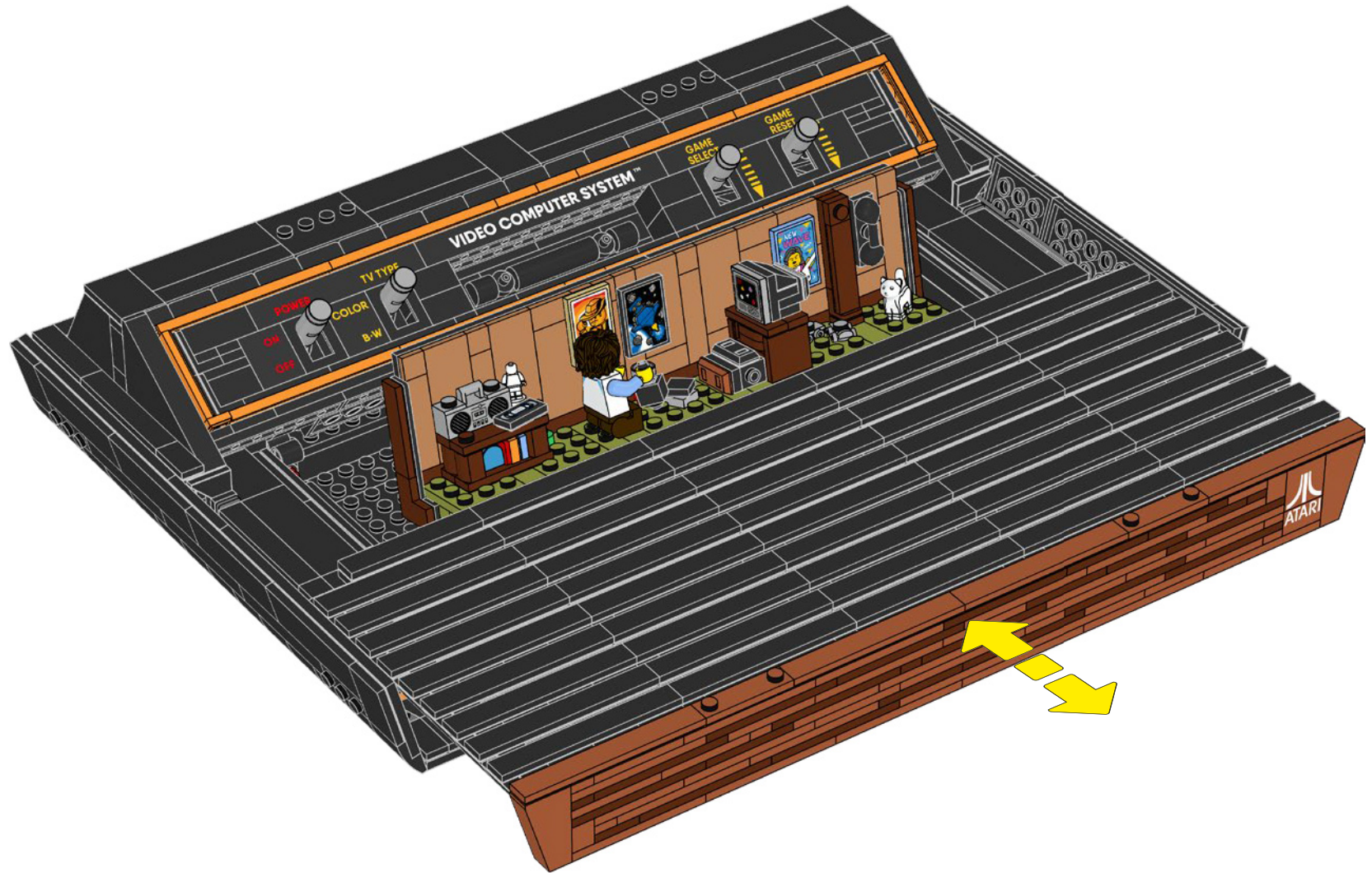

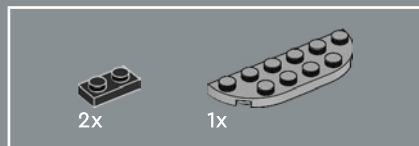
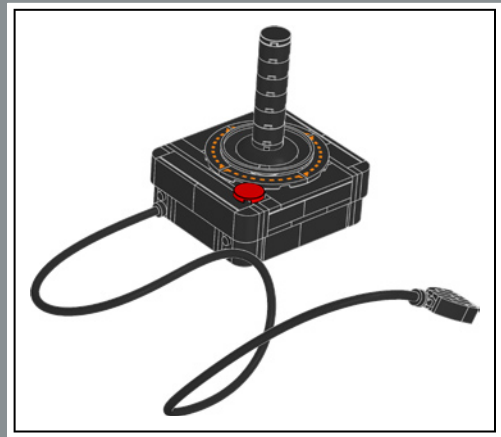
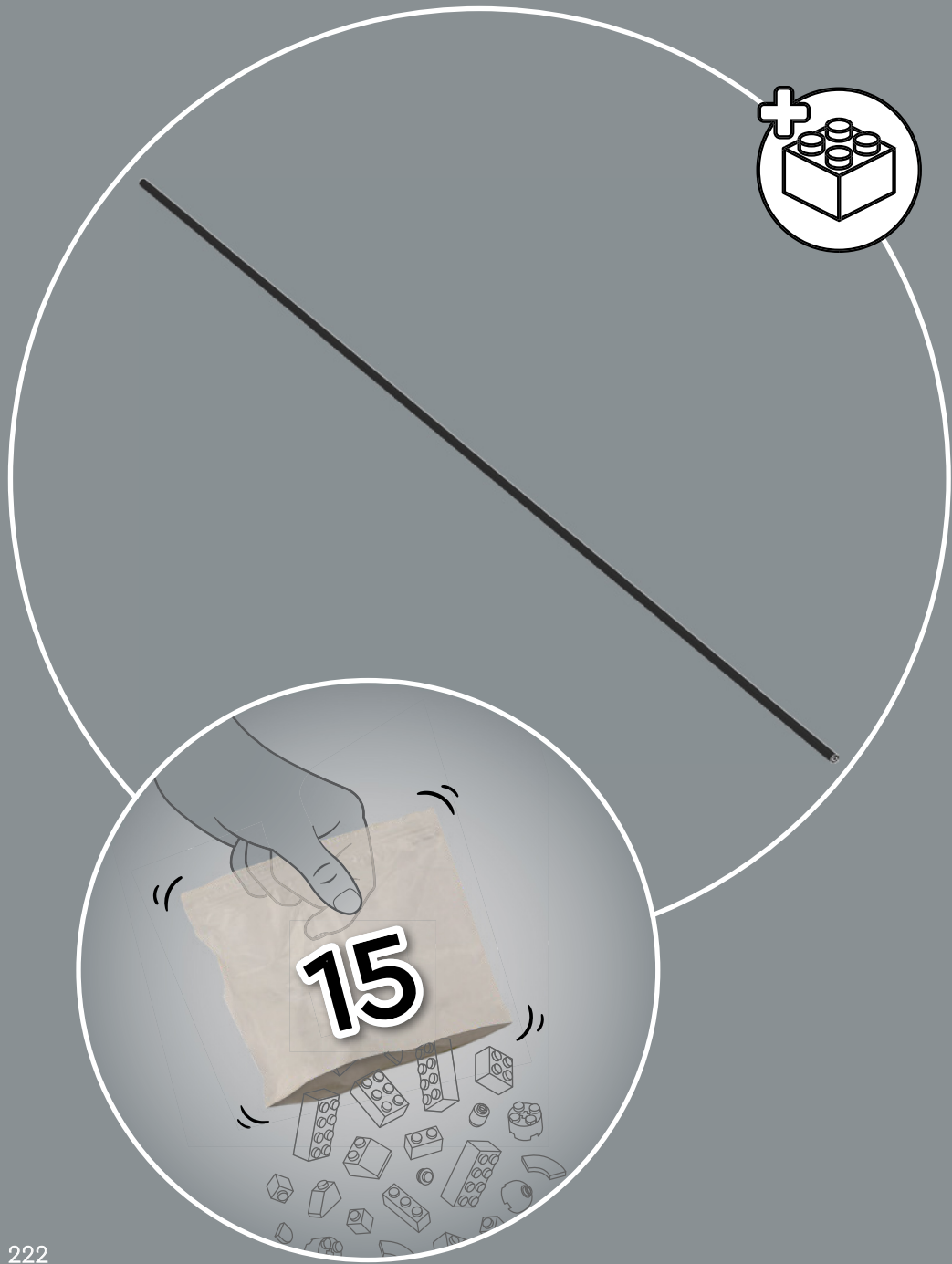

1

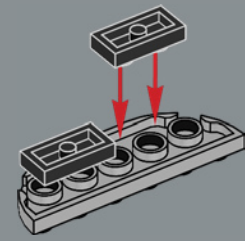

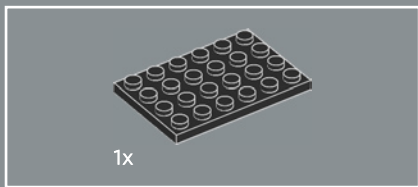

2

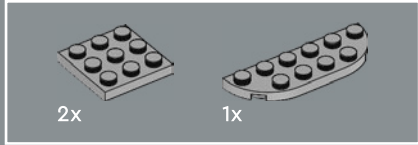
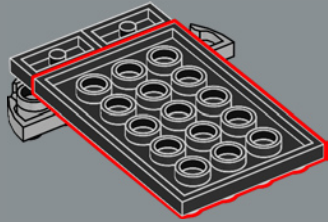

3

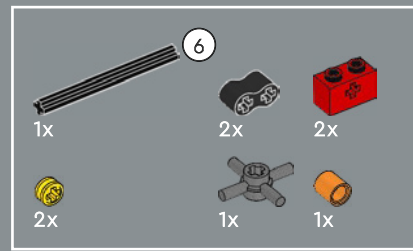
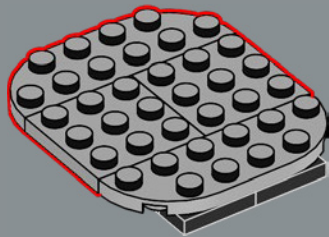

4

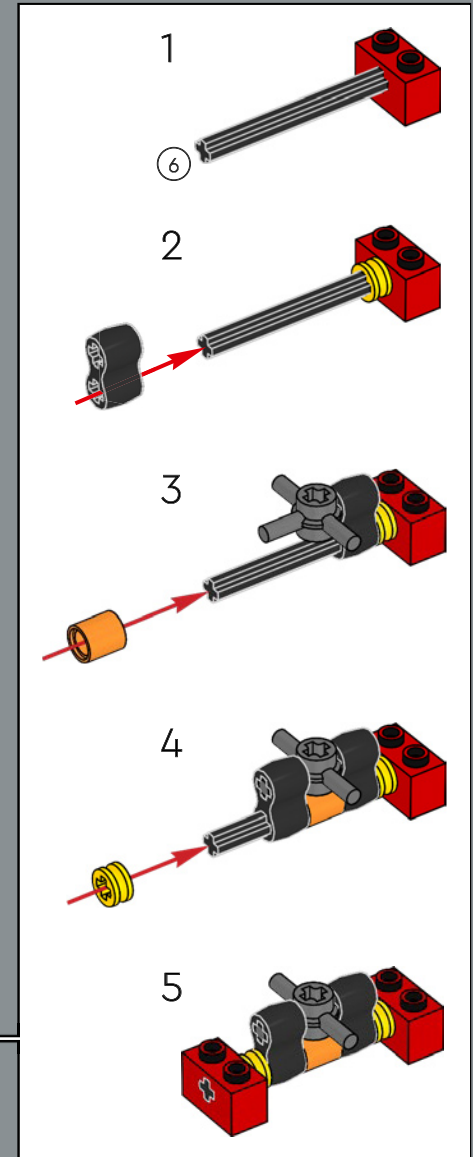
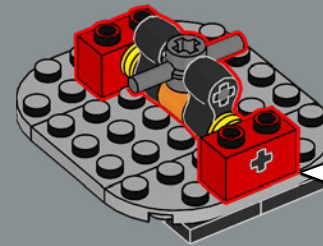

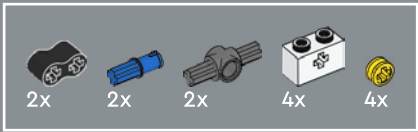

5

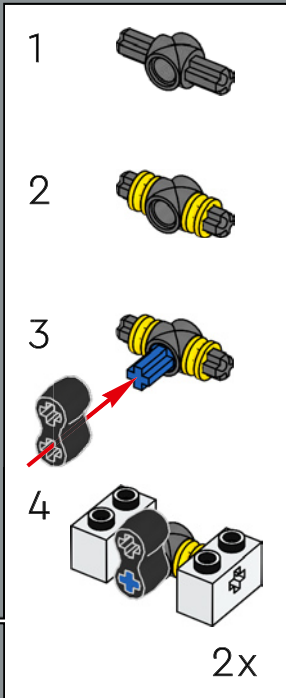
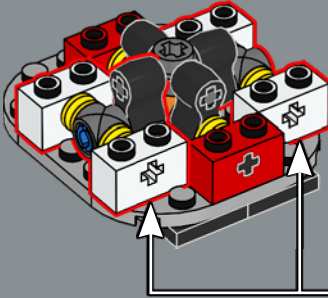

6

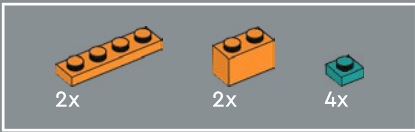
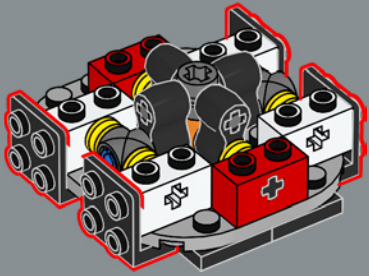

7

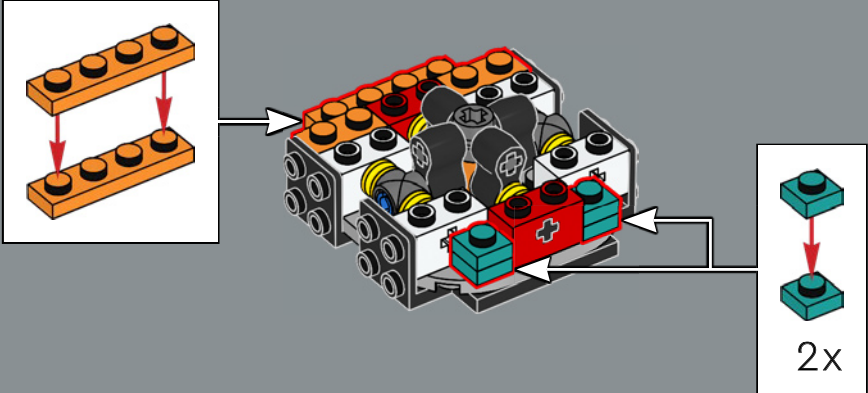

8

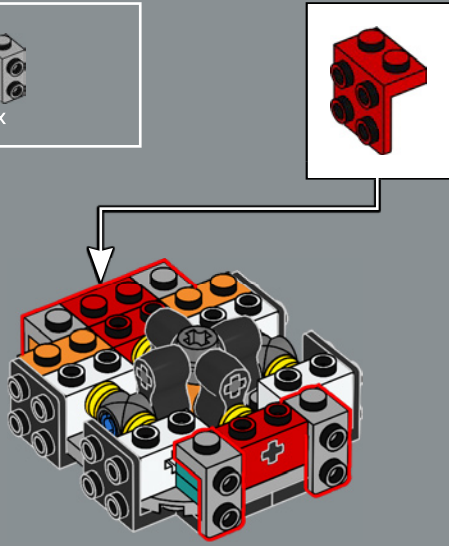

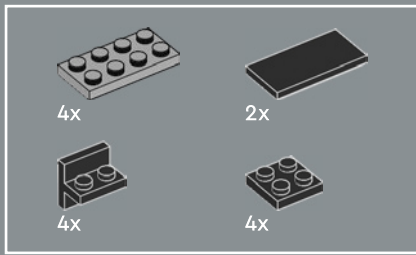

9

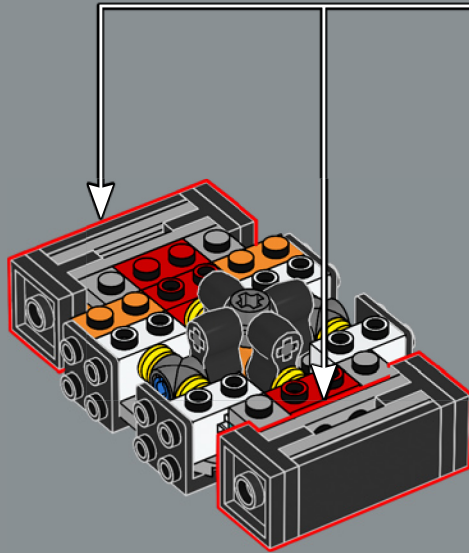
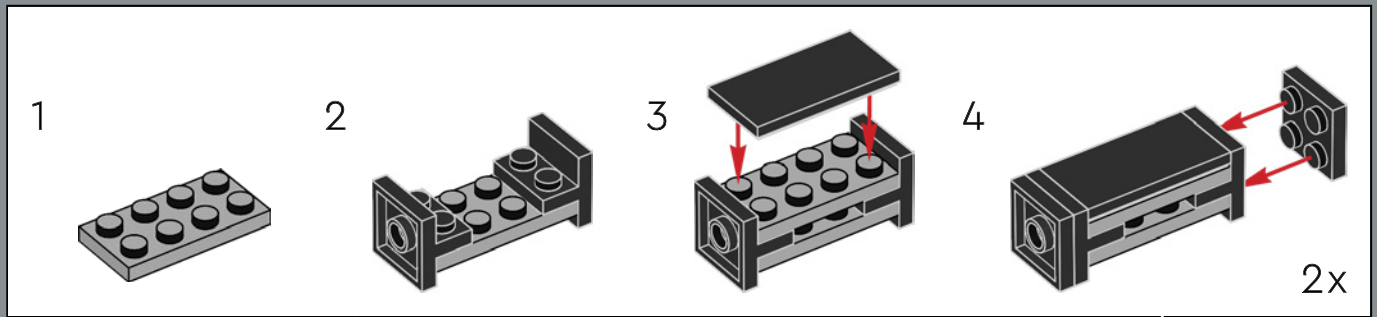

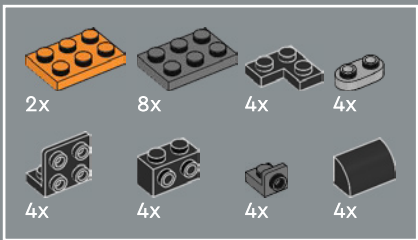

10

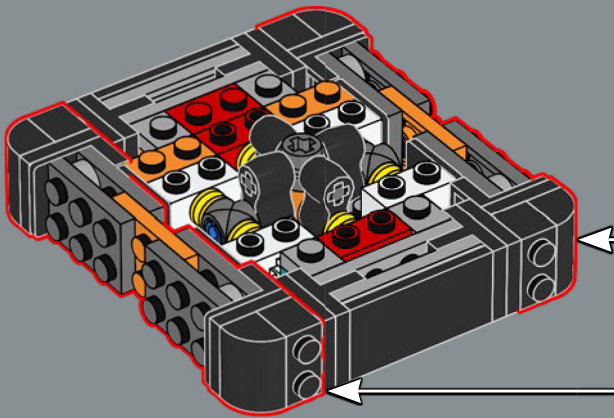
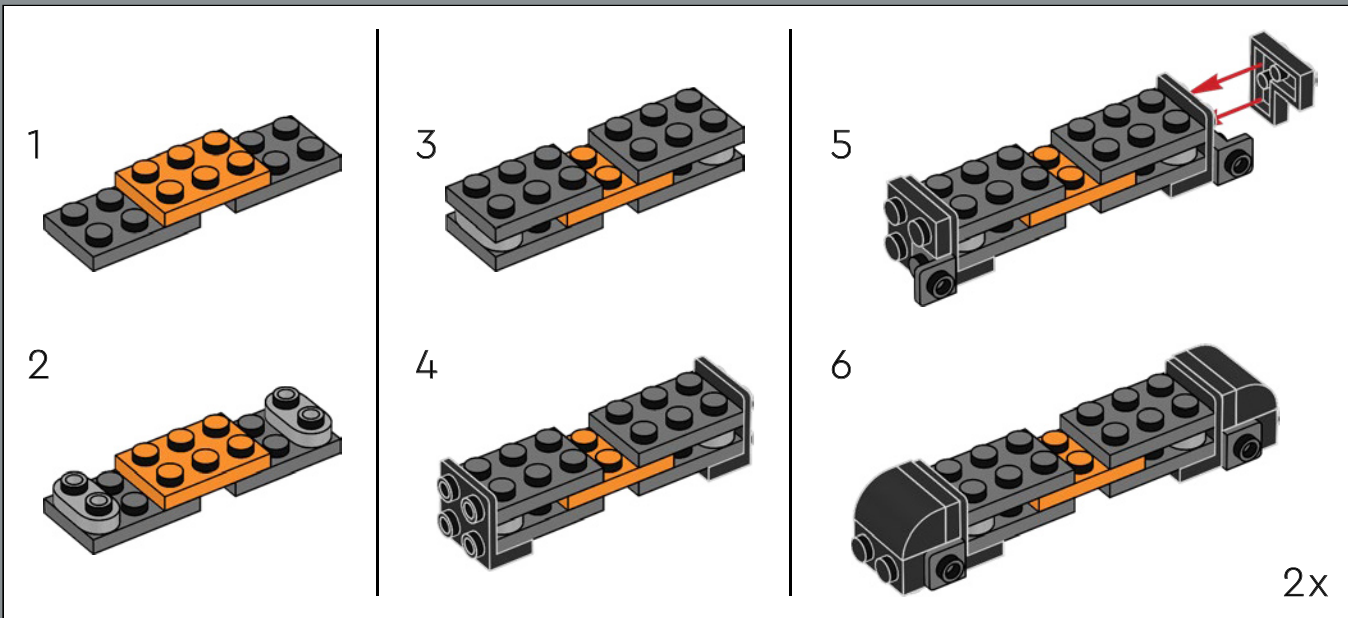

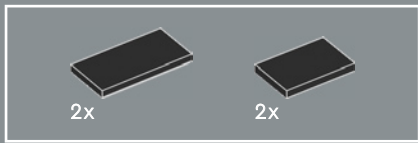

11

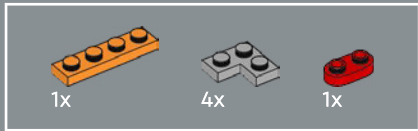
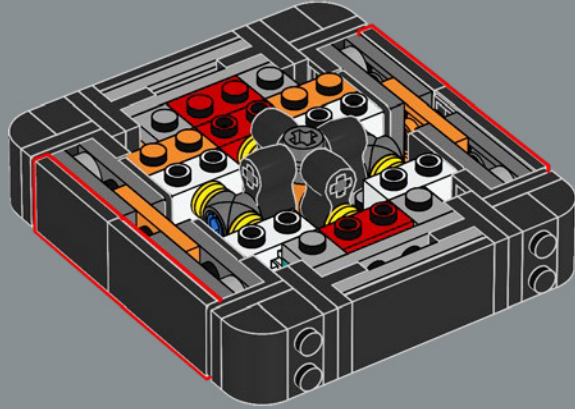

12

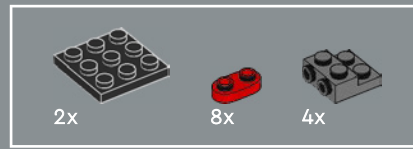
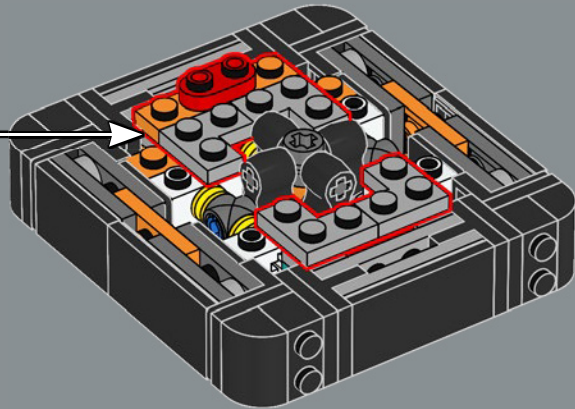
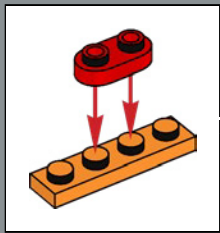

13

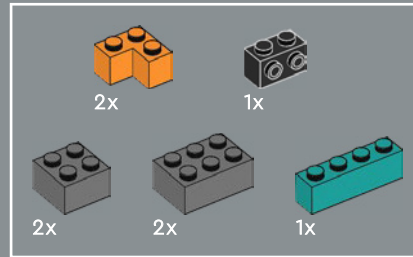
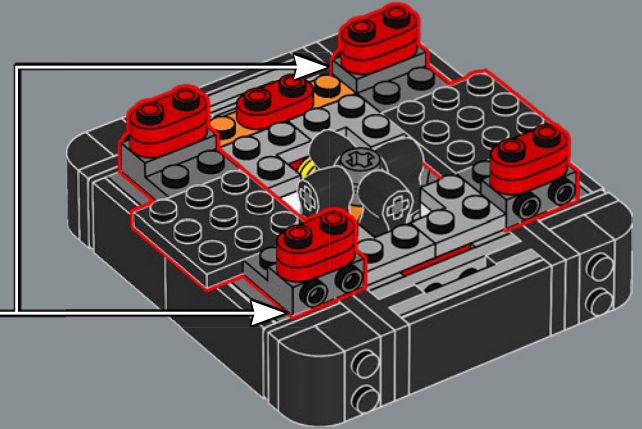
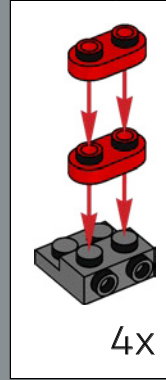

14

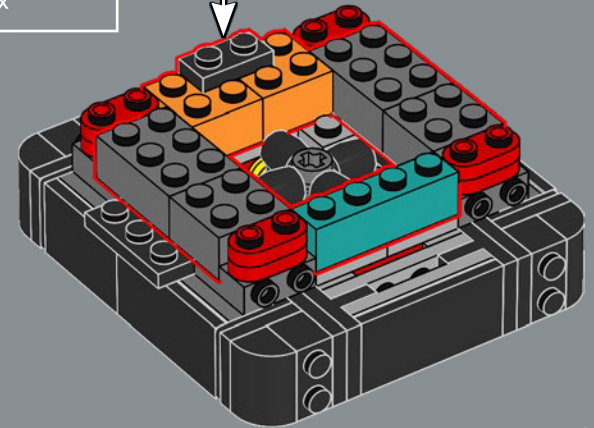
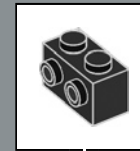

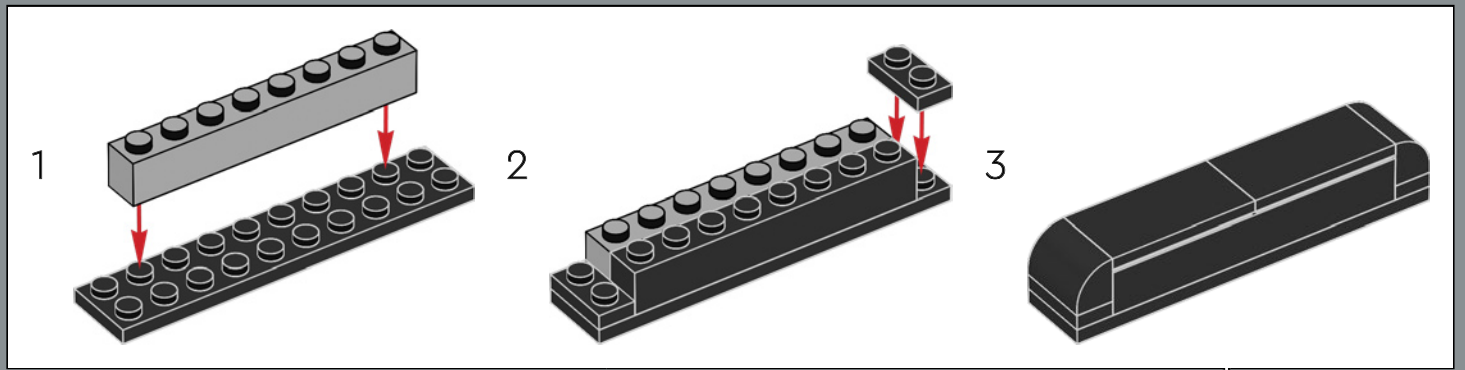
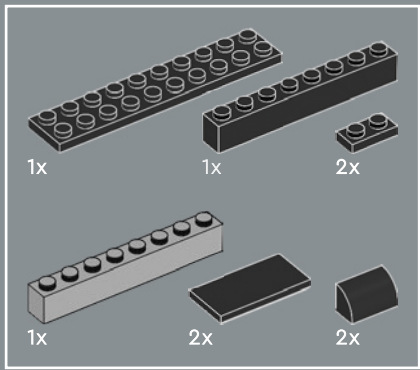

15

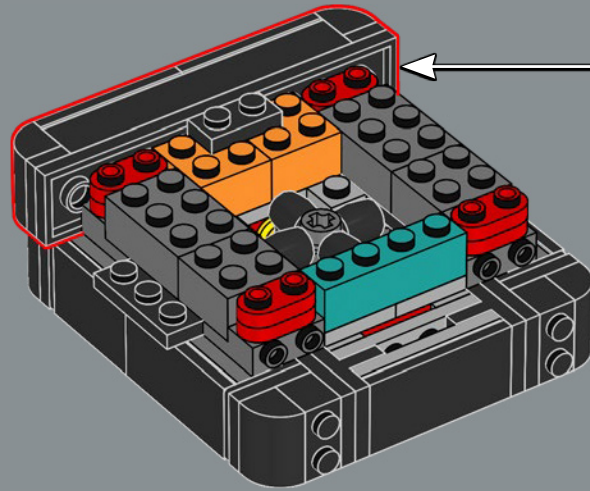

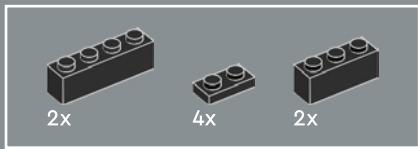

16

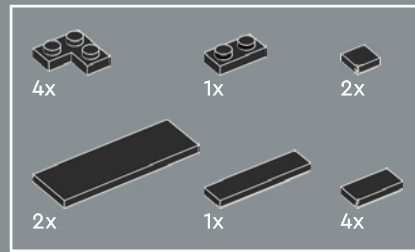
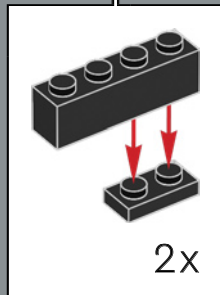
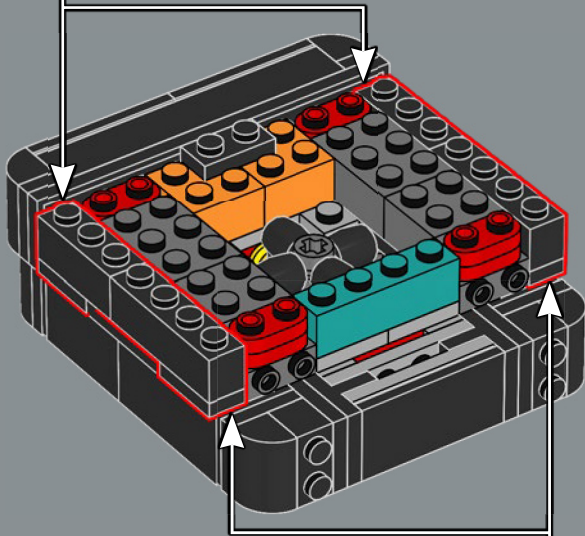
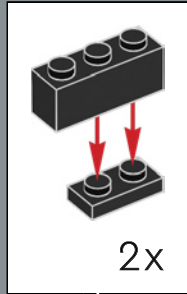

17

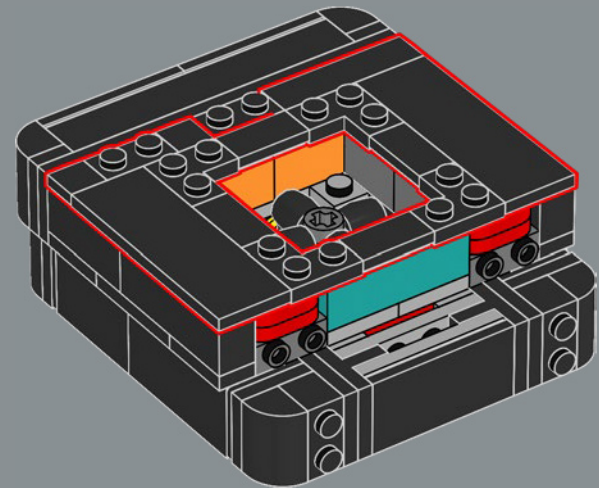

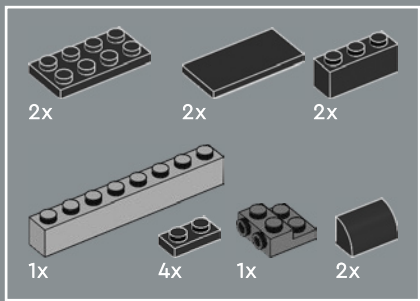

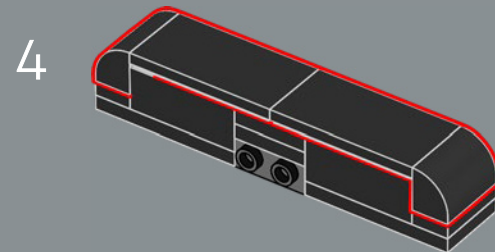
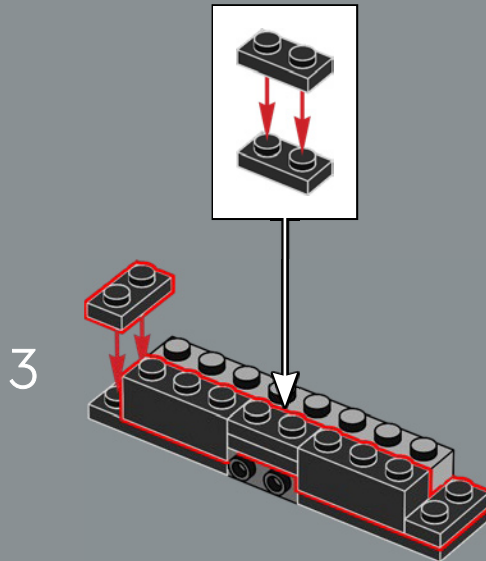
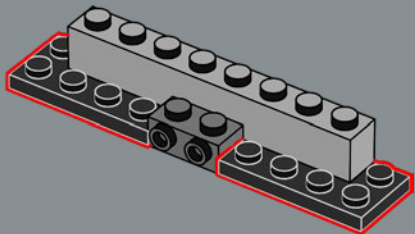
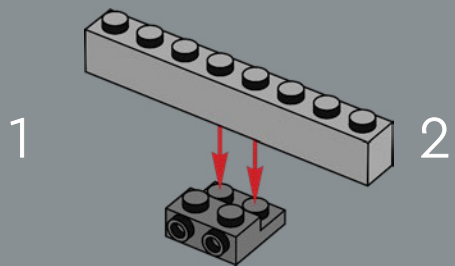

18

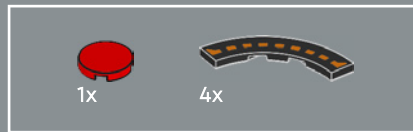
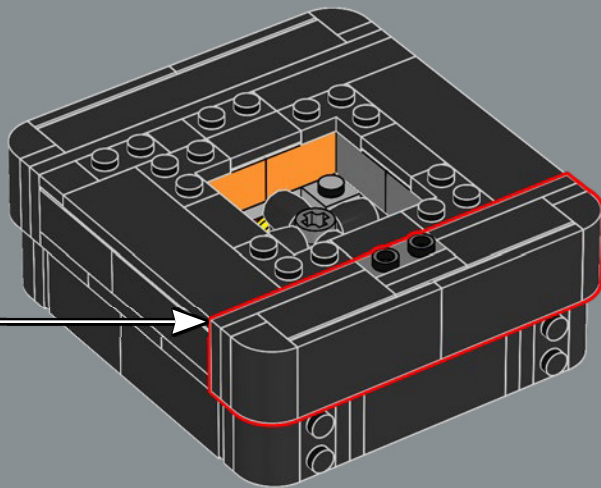

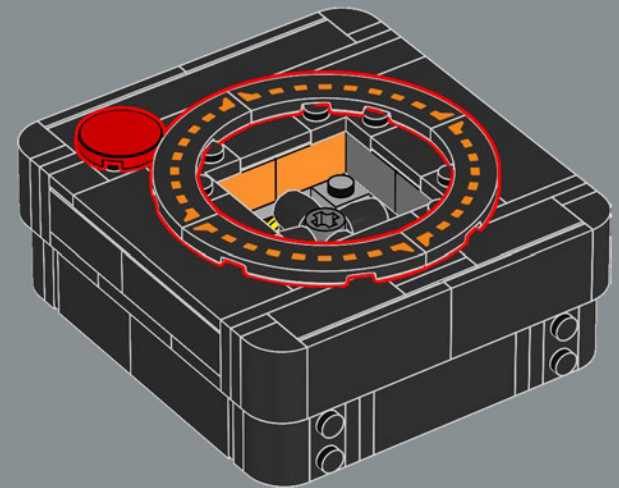

19



 The ATARI® Video Computer System joystick is so iconic that its shape and bright red button is often used in graphical icons to represent gaming.

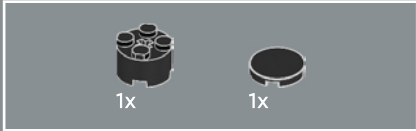
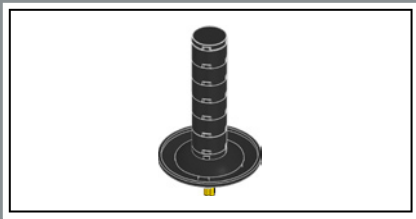

20

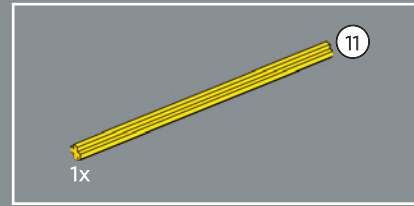
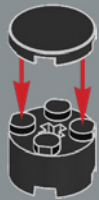

21



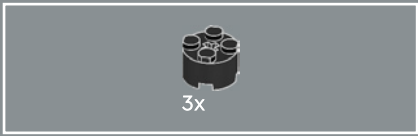

22

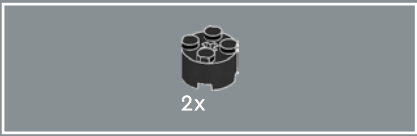
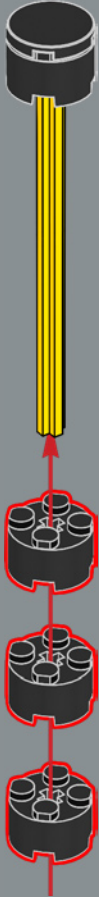

23

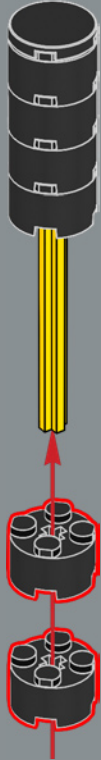

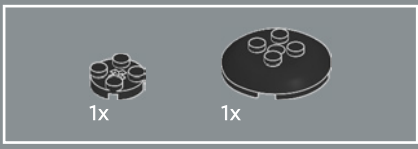

24

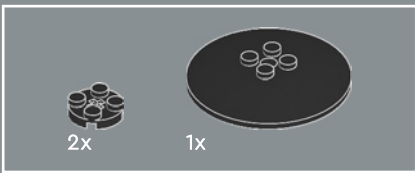
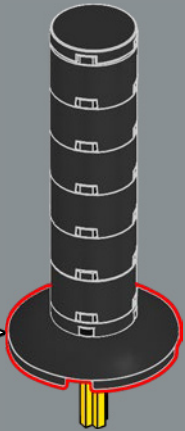
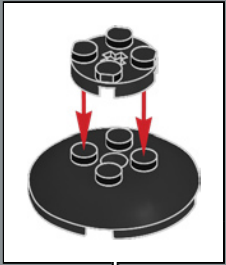

25

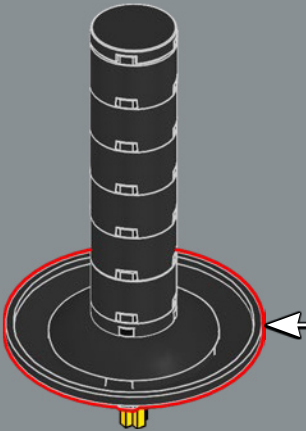
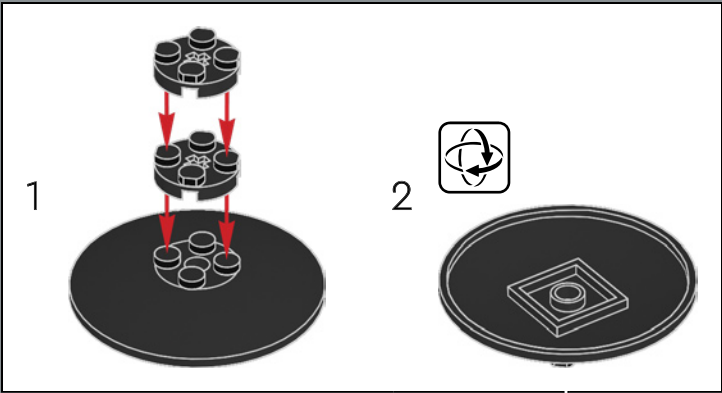

26

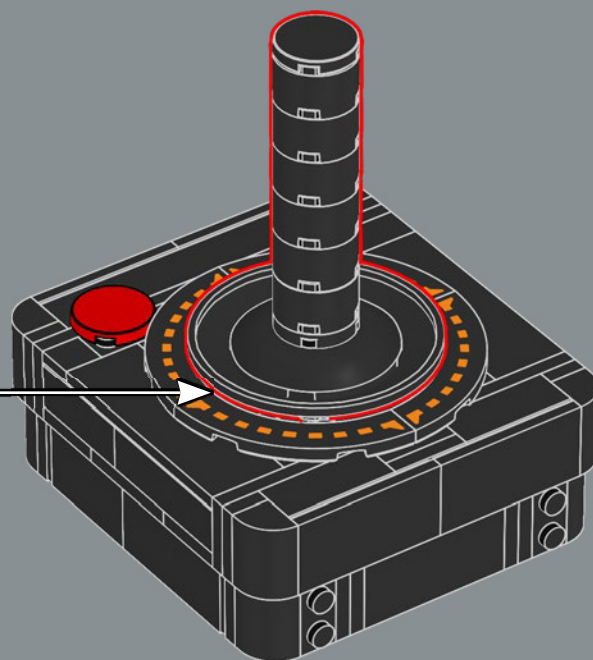

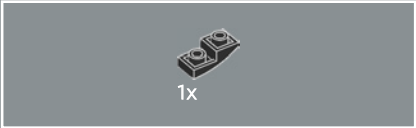
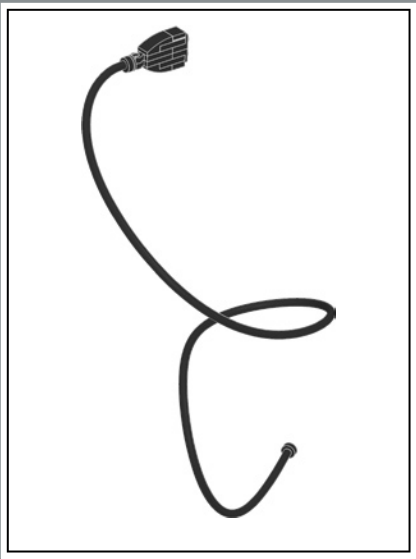

27

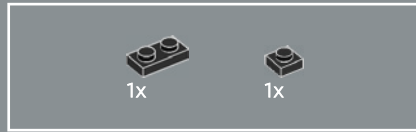
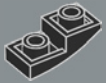

28

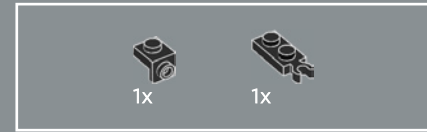
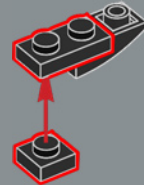

29

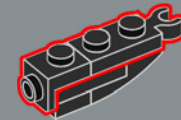



30

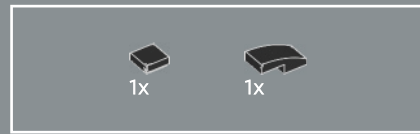
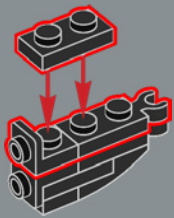

31

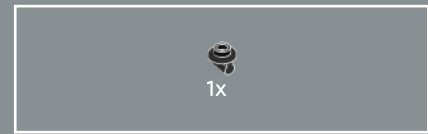
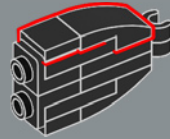

32

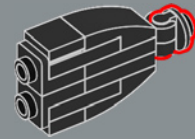



2x

33



2x

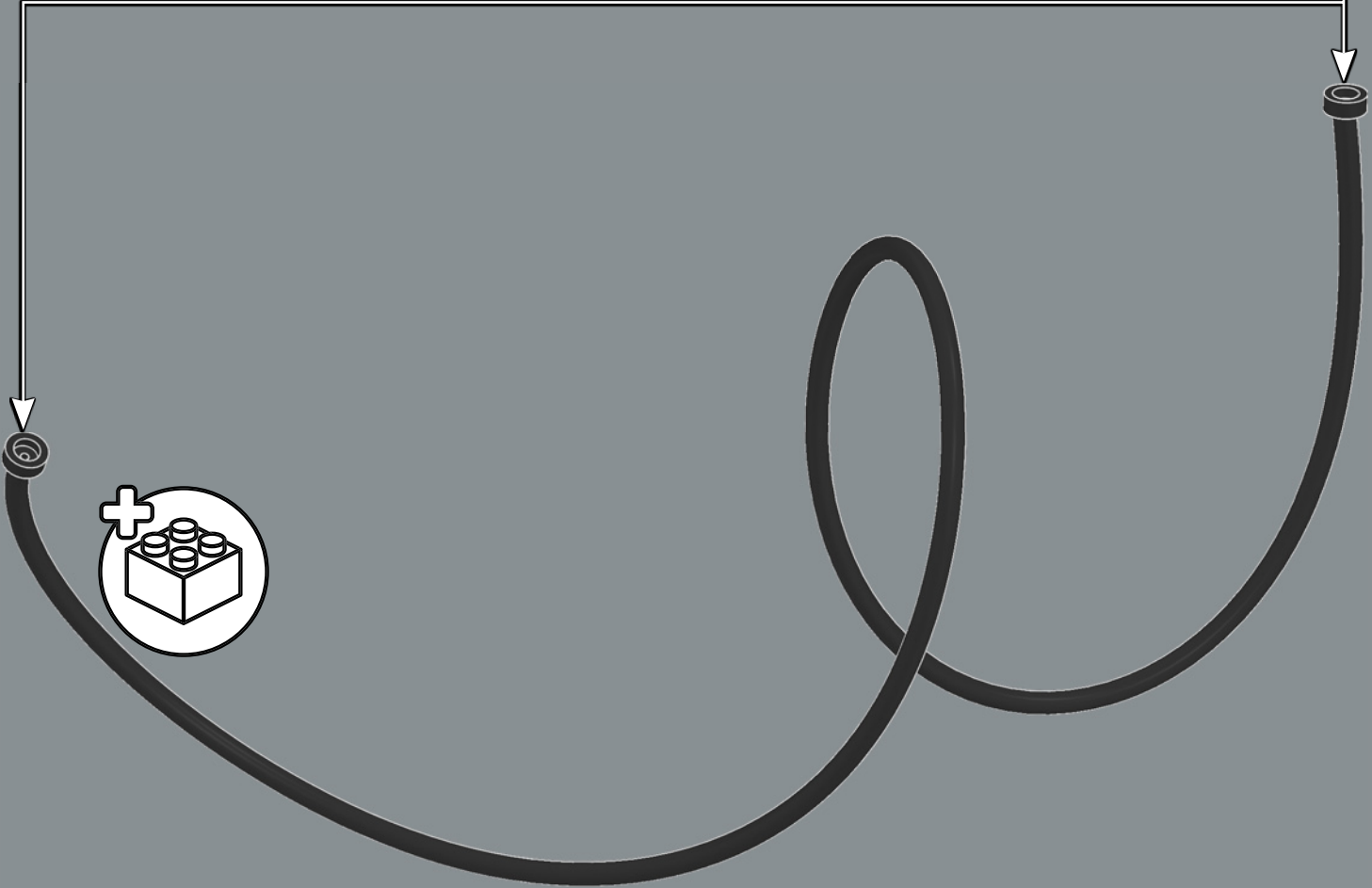

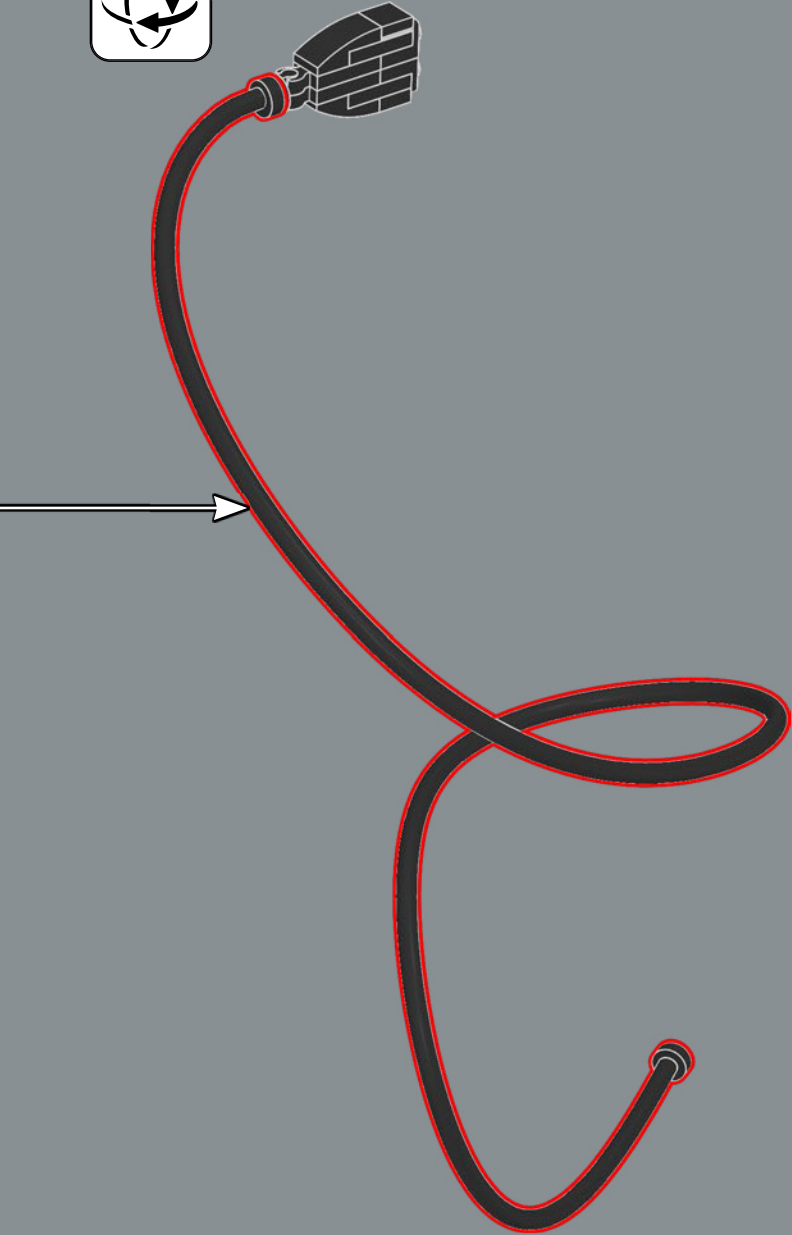

34

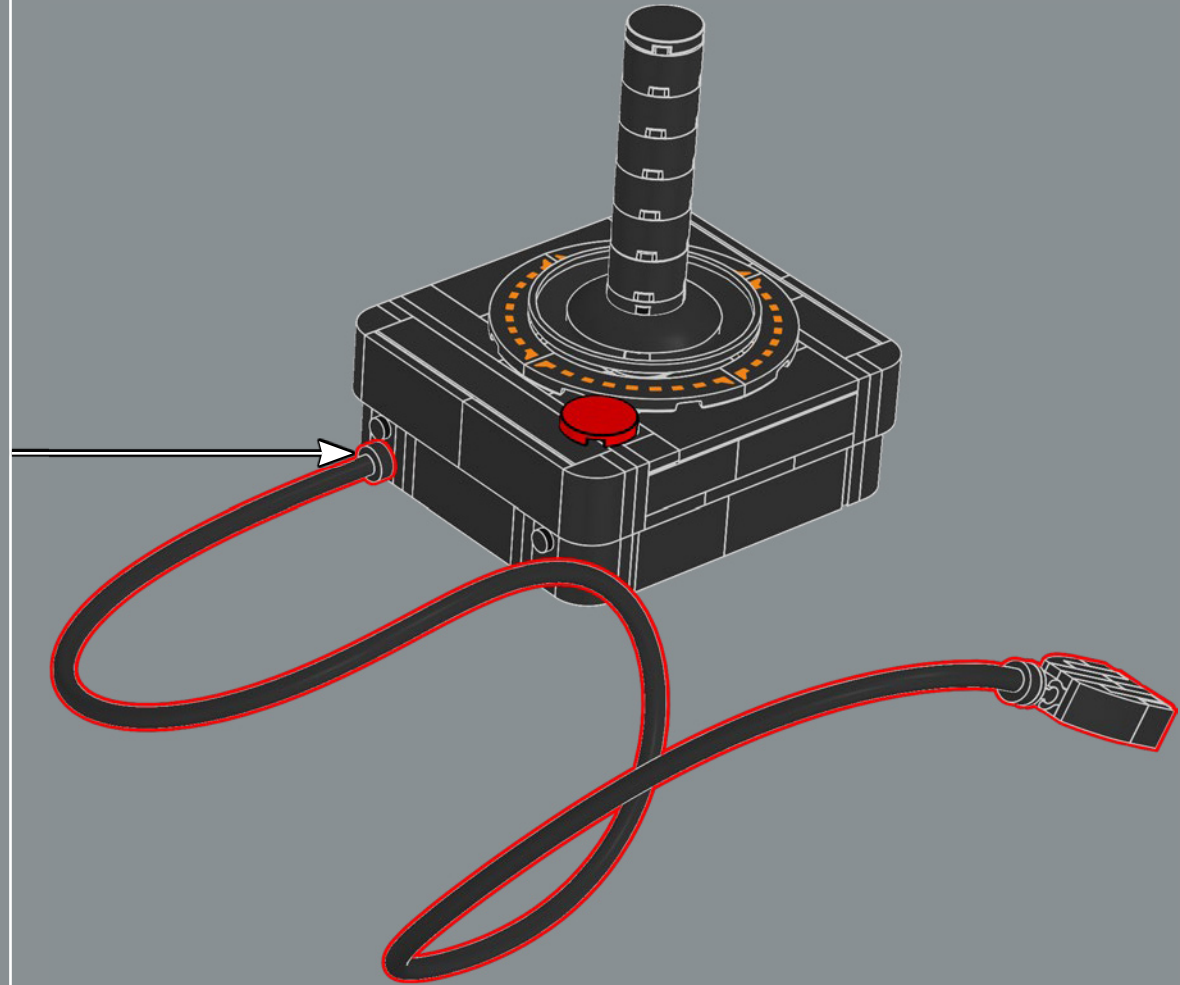

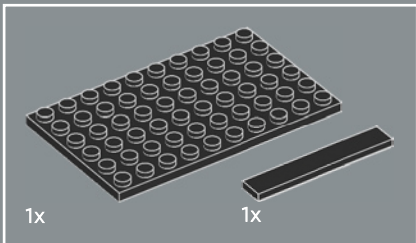

1

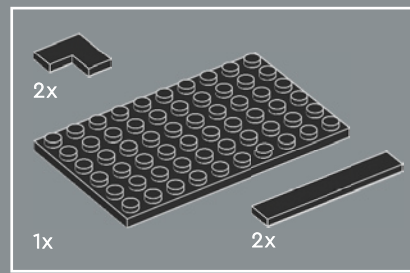
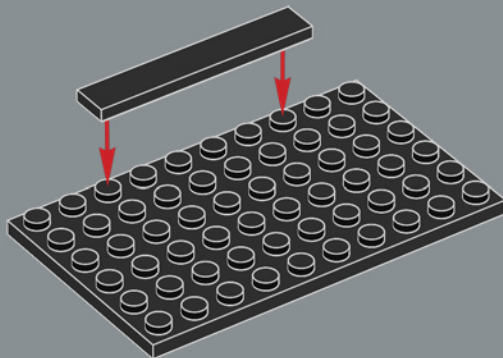

2

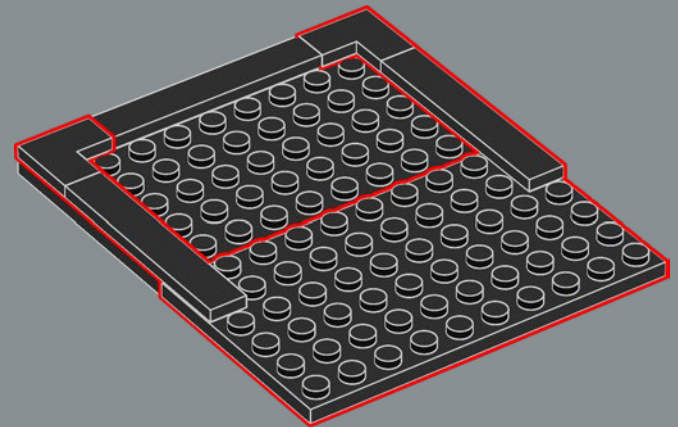

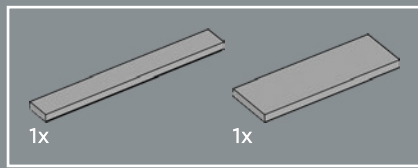

3

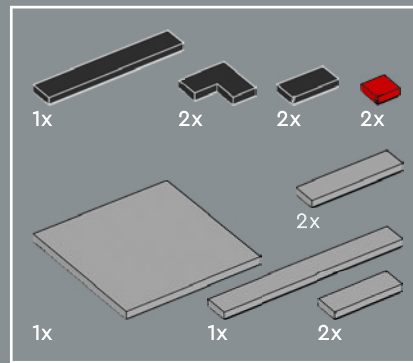
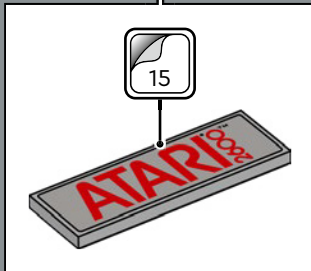
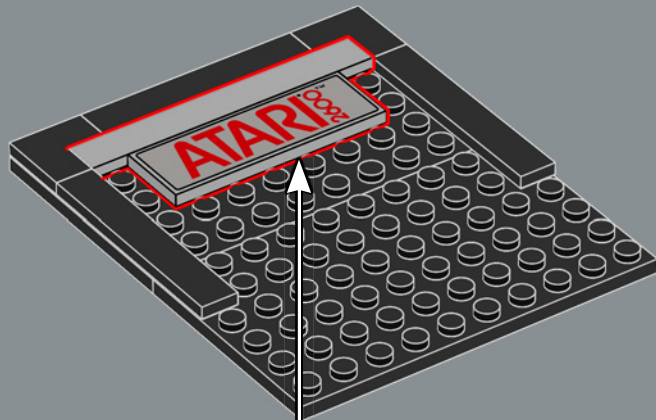

4

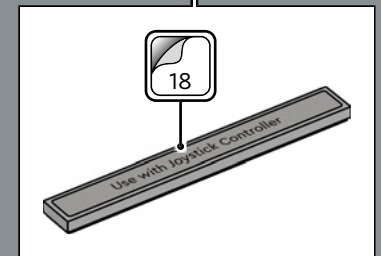

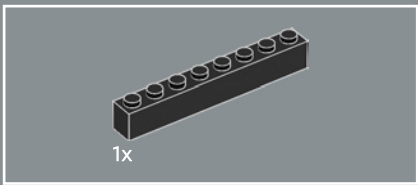

5

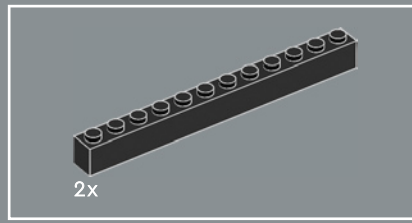
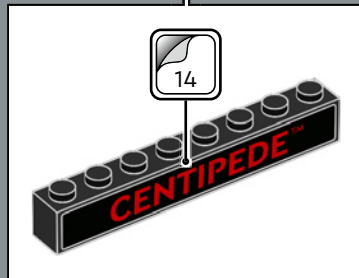

6

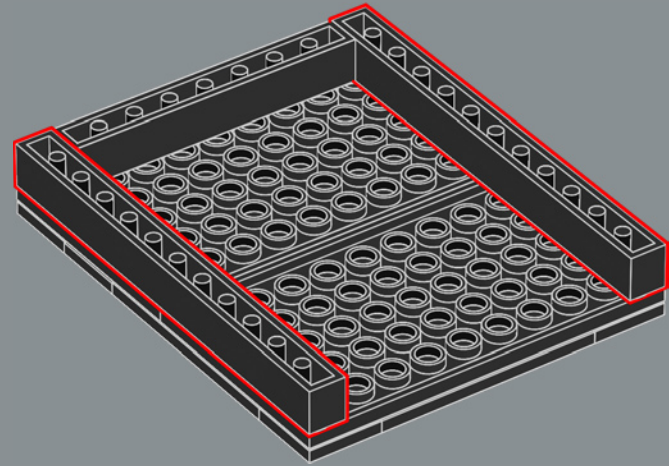

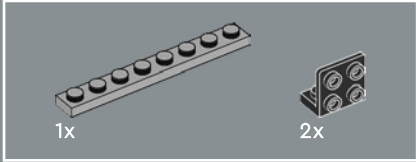
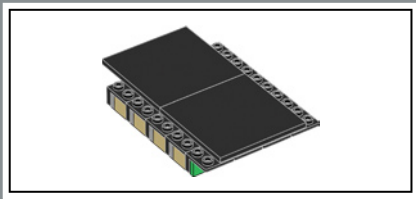

7

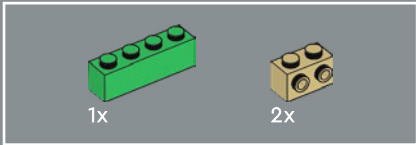
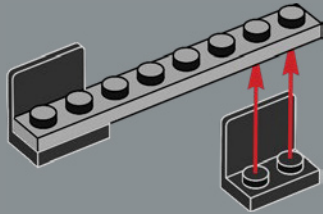

8

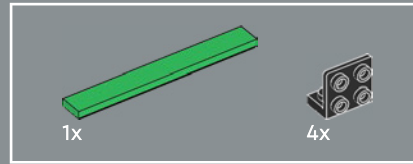
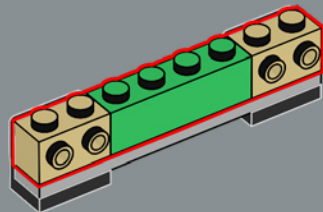

9

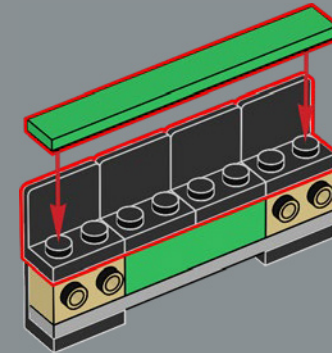

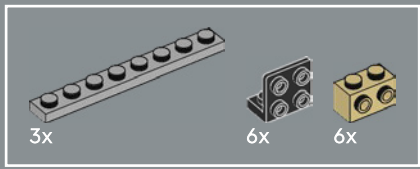

10

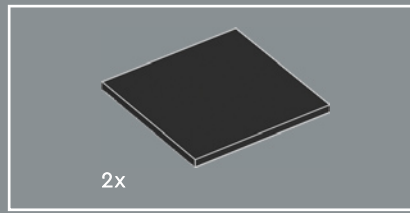
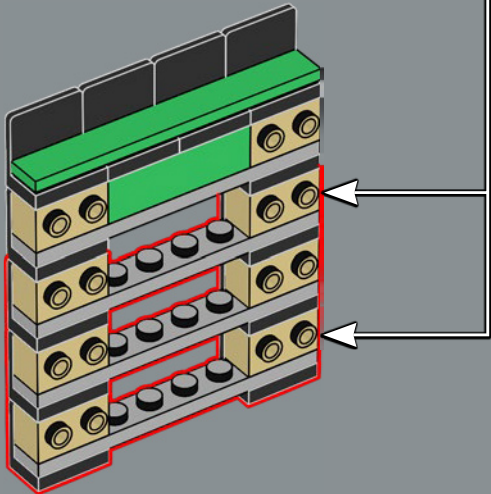
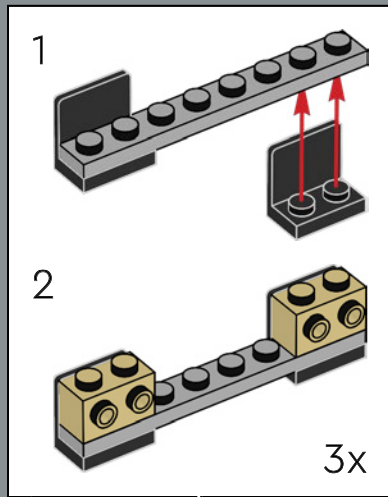

11

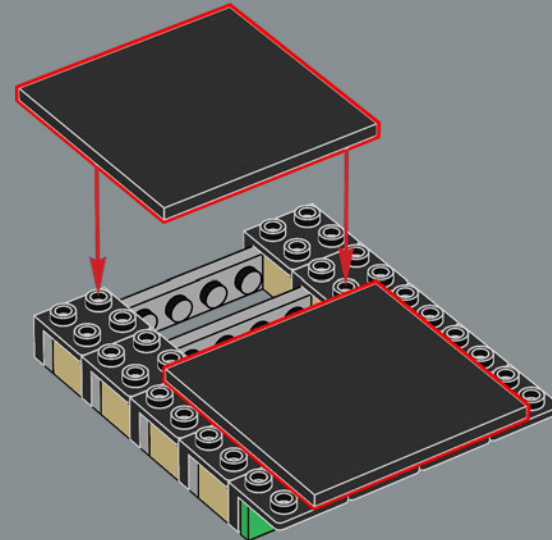

12

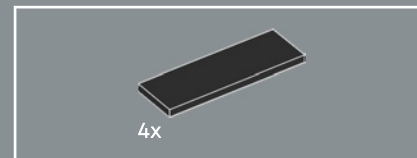
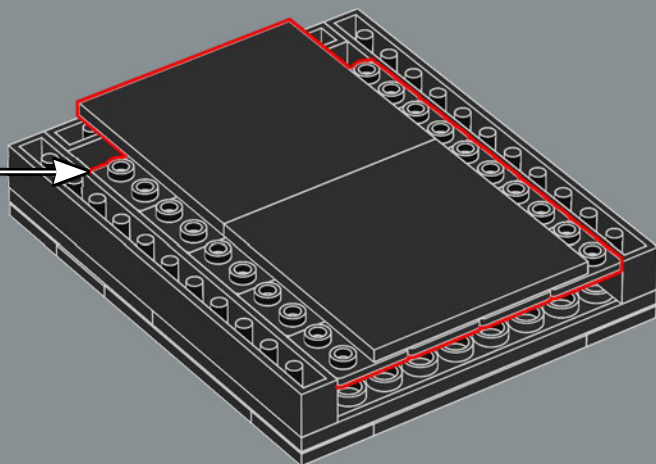

13

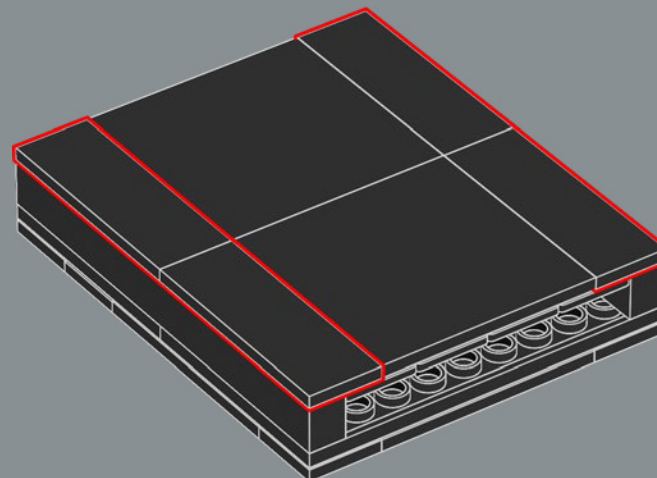

14



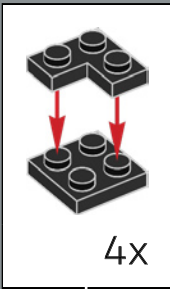
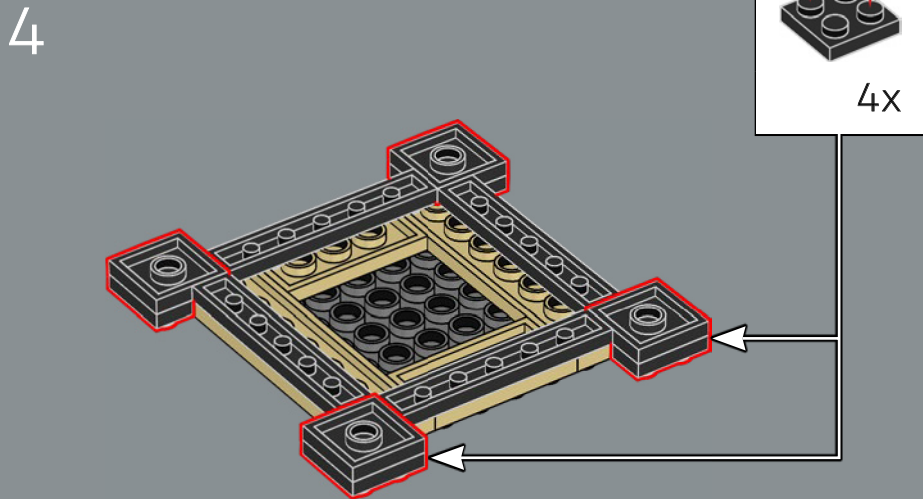
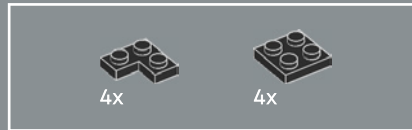
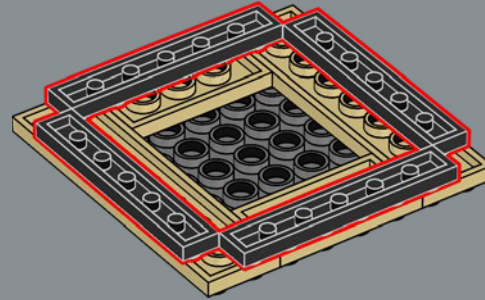
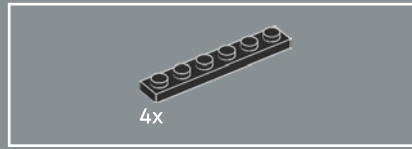
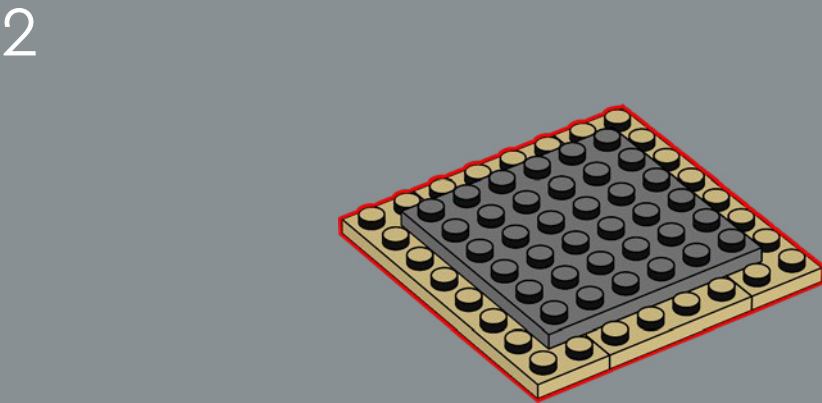
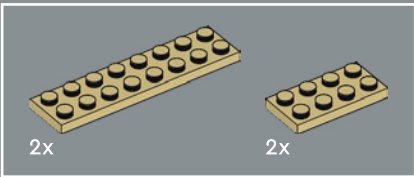
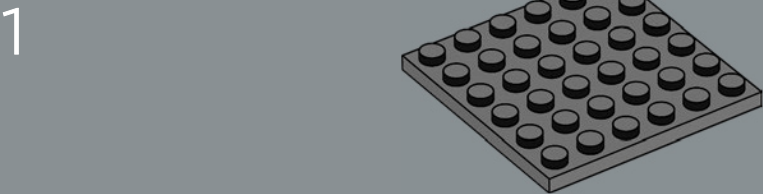
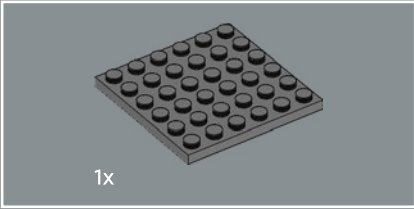
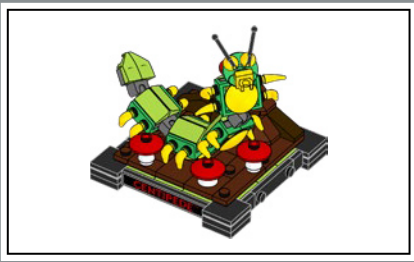

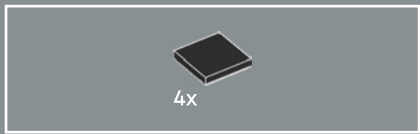

5

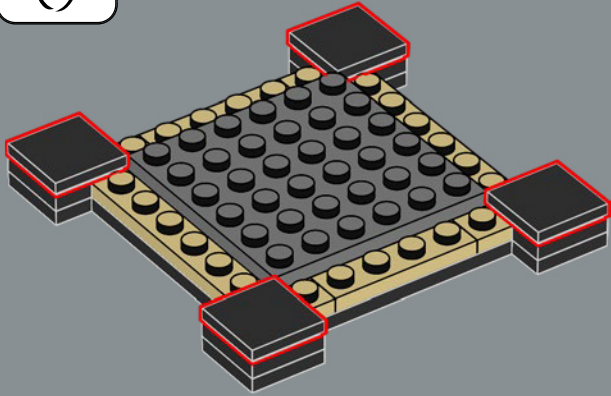

6

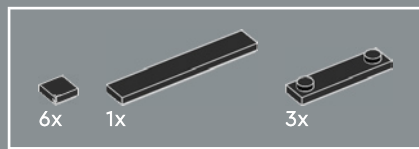
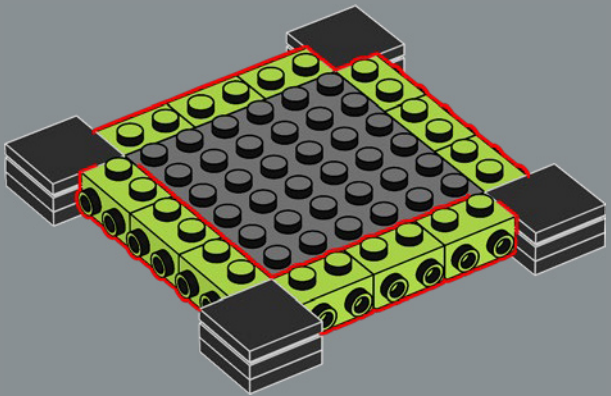

7

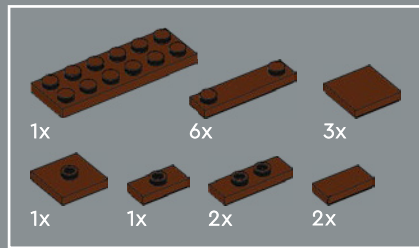
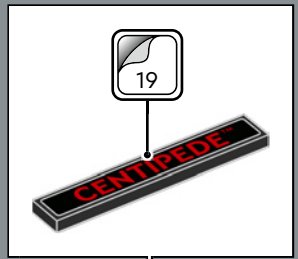
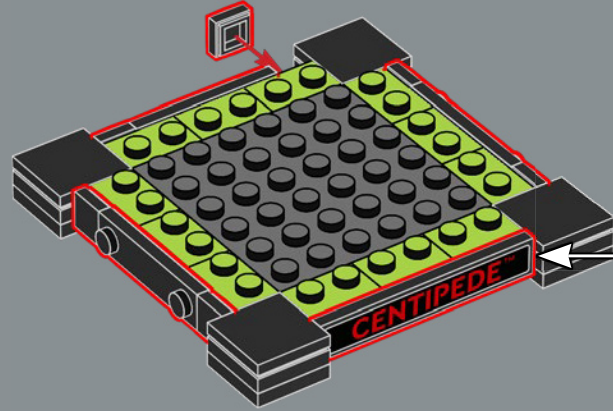

8

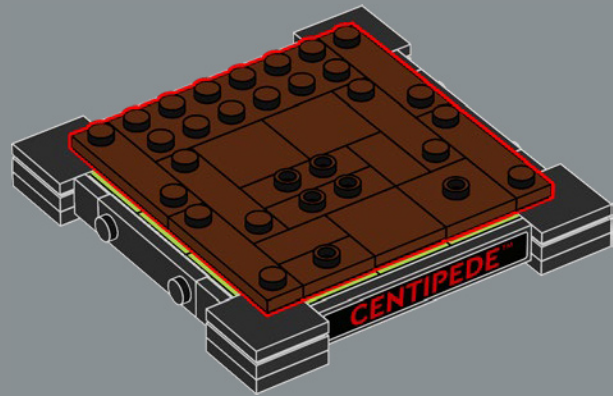

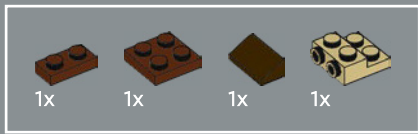

9

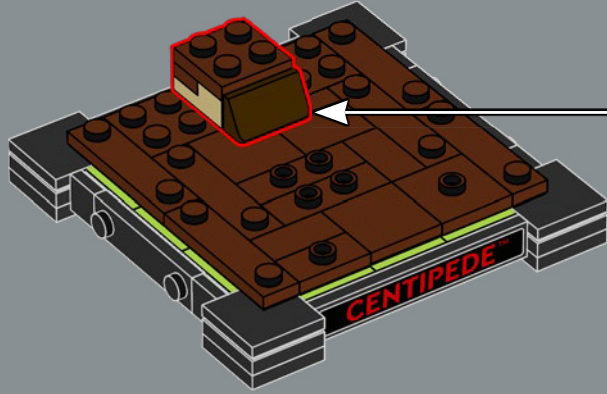
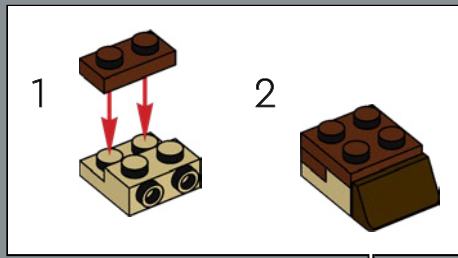

10

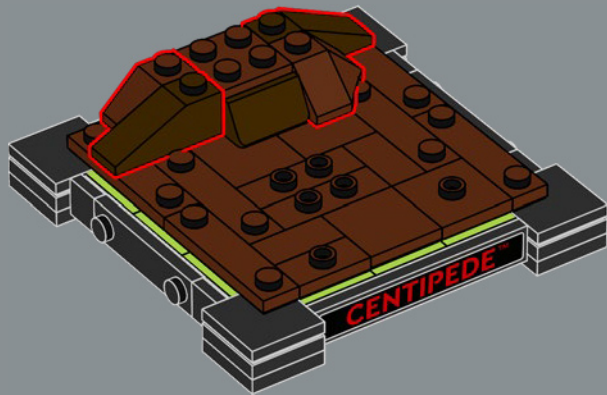

11

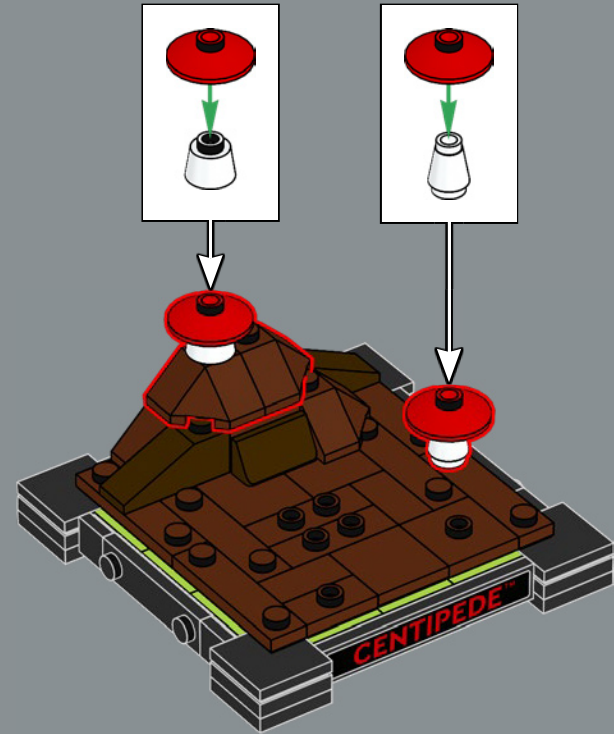

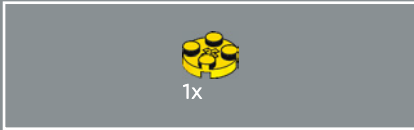
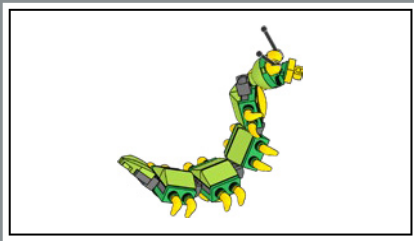

12



13

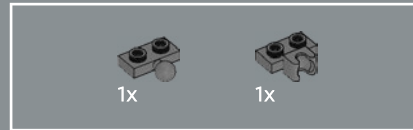

14

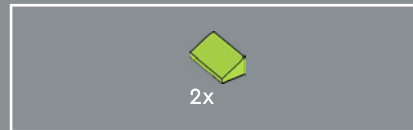
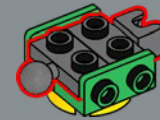

15

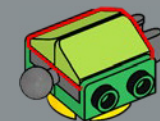



4x

16

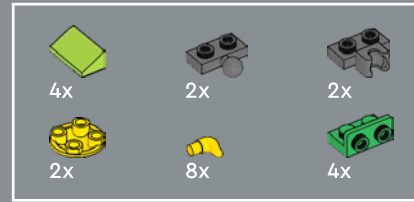
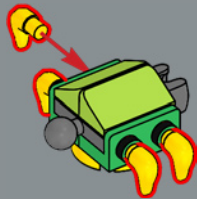

17

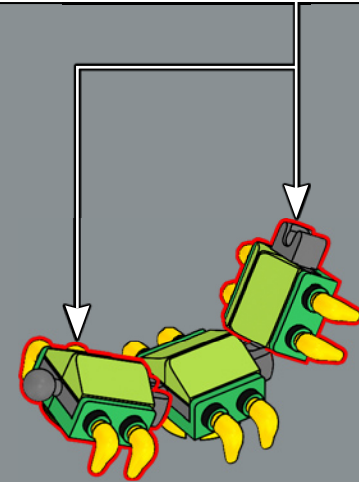
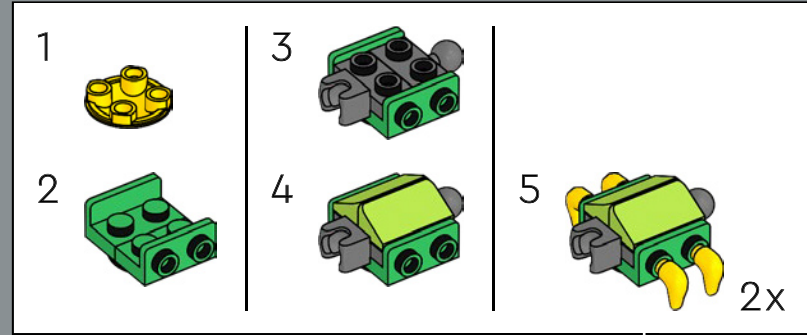

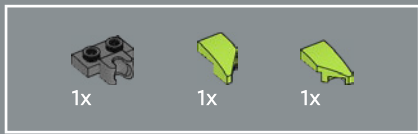

18

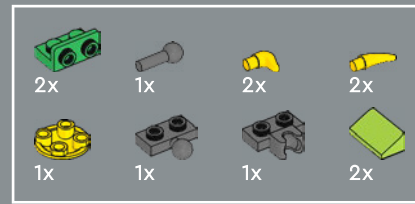
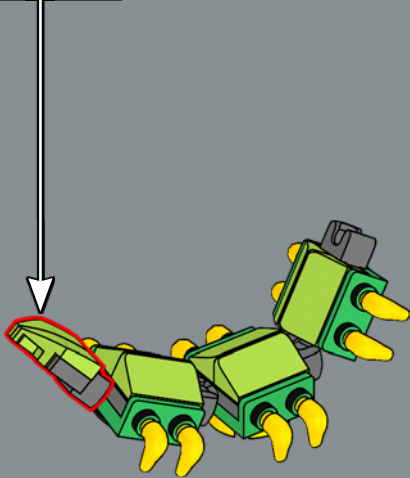
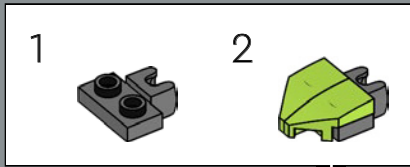

19

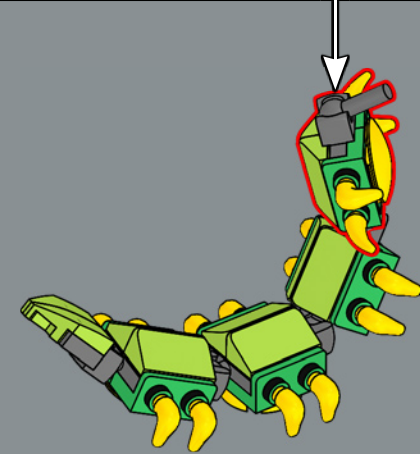
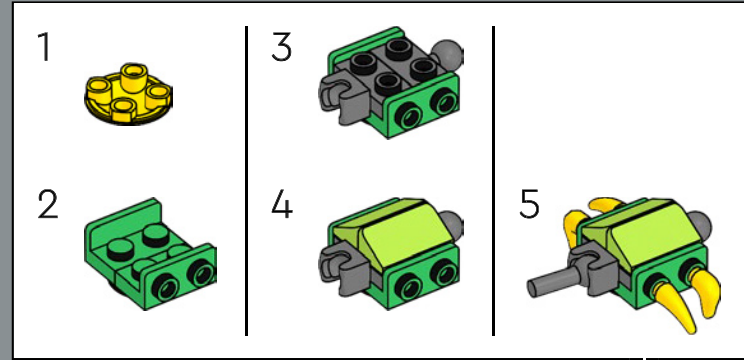

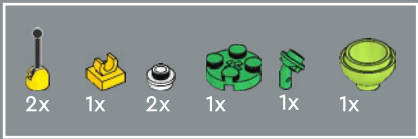

20

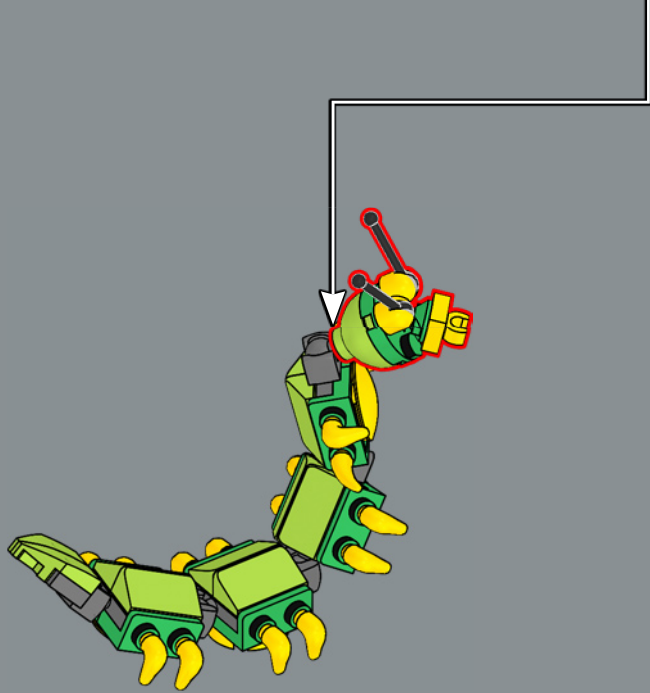
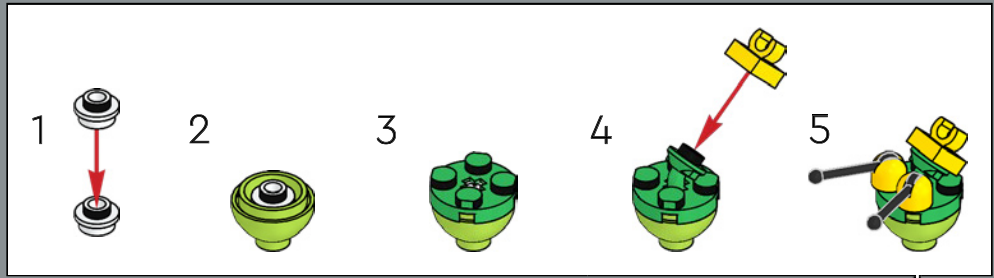

21

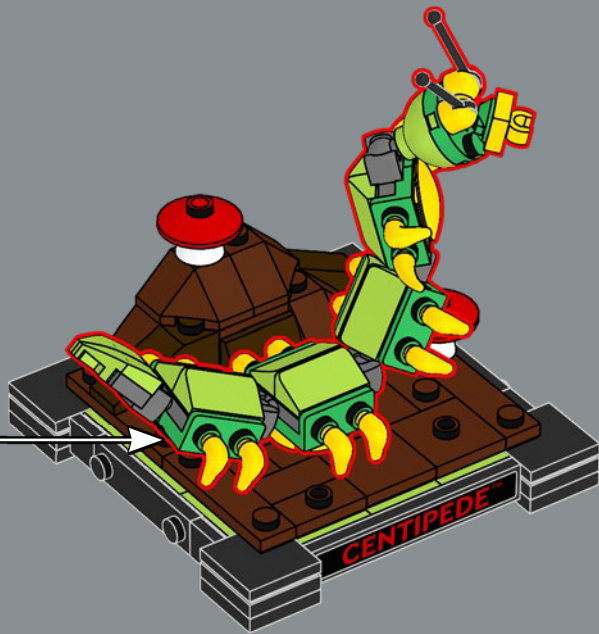

22

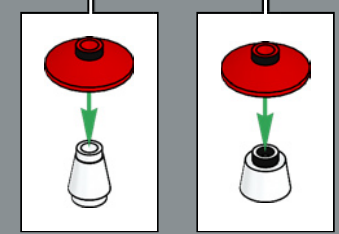
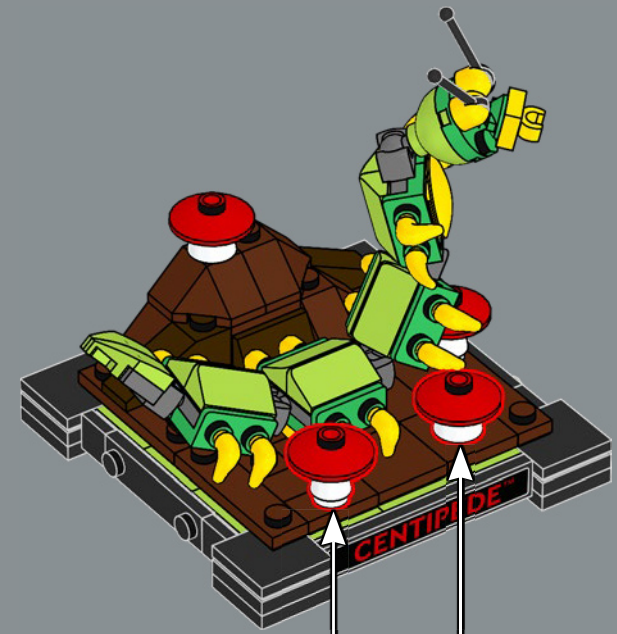
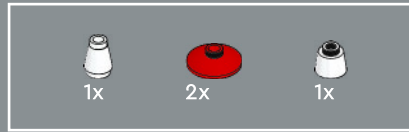

 The ATARI® Video Computer System debuted on 11 September 1977, for a price of \$189.95 US (over \$800 in today's money!)

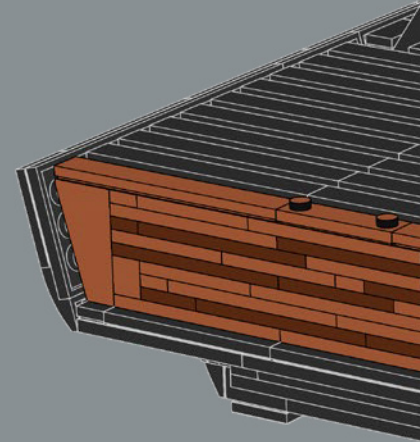
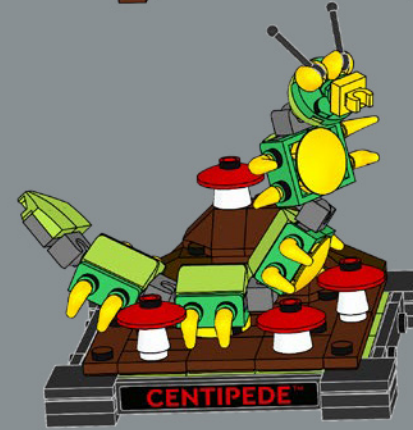
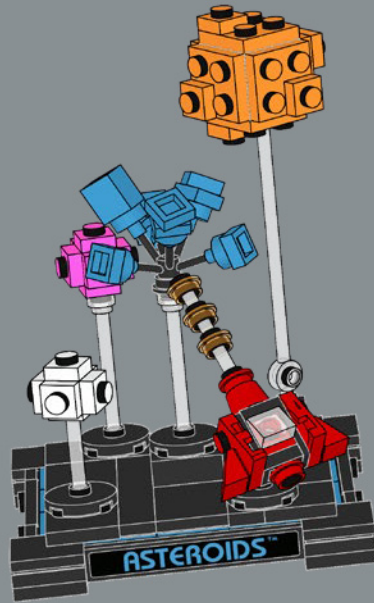
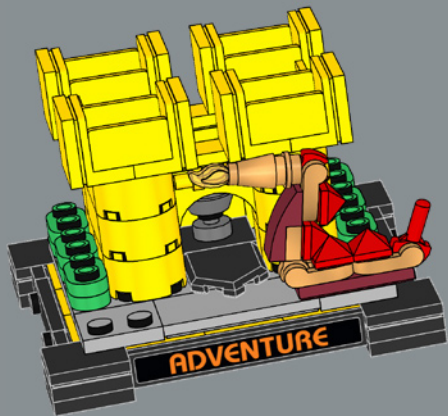

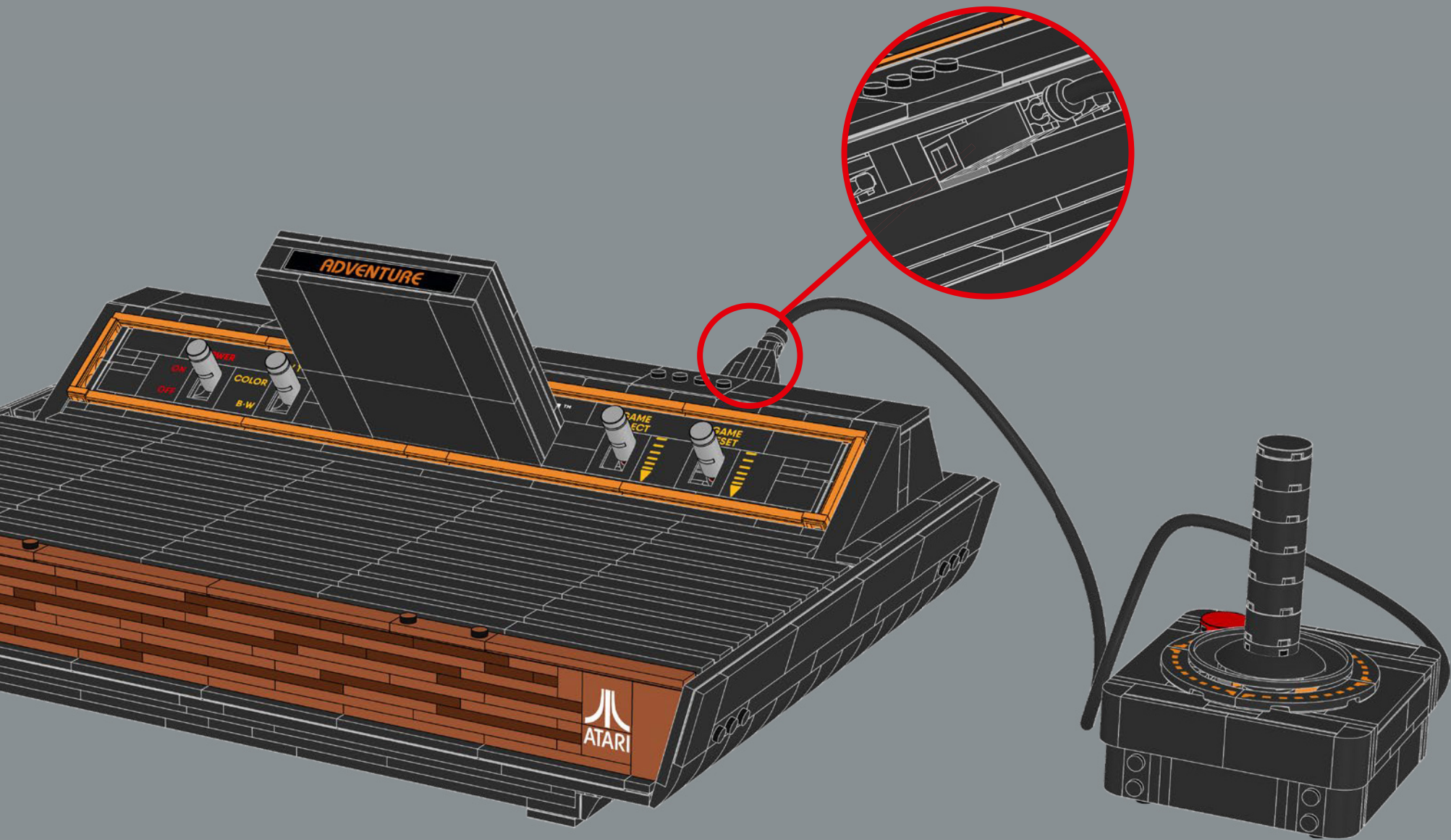

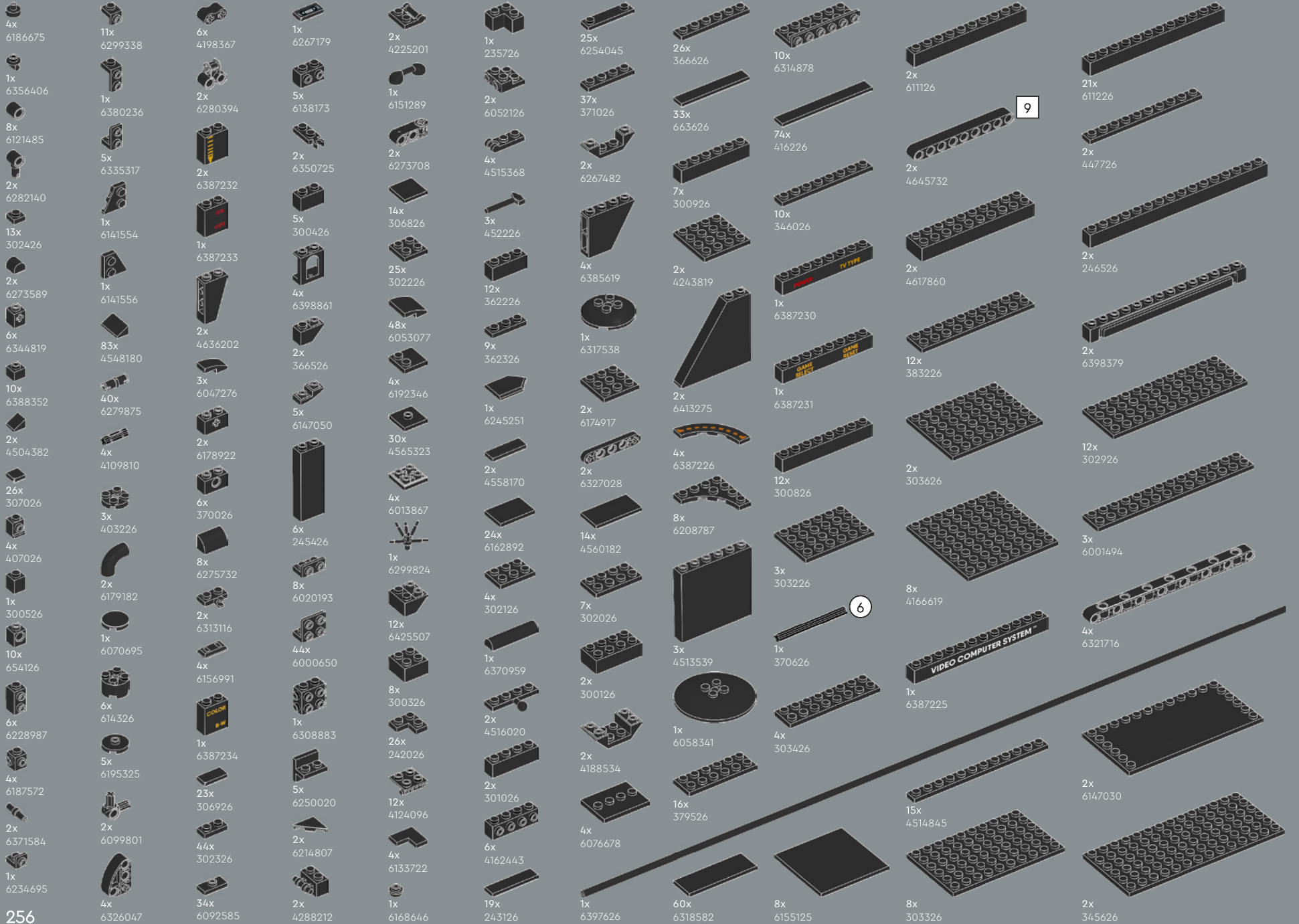

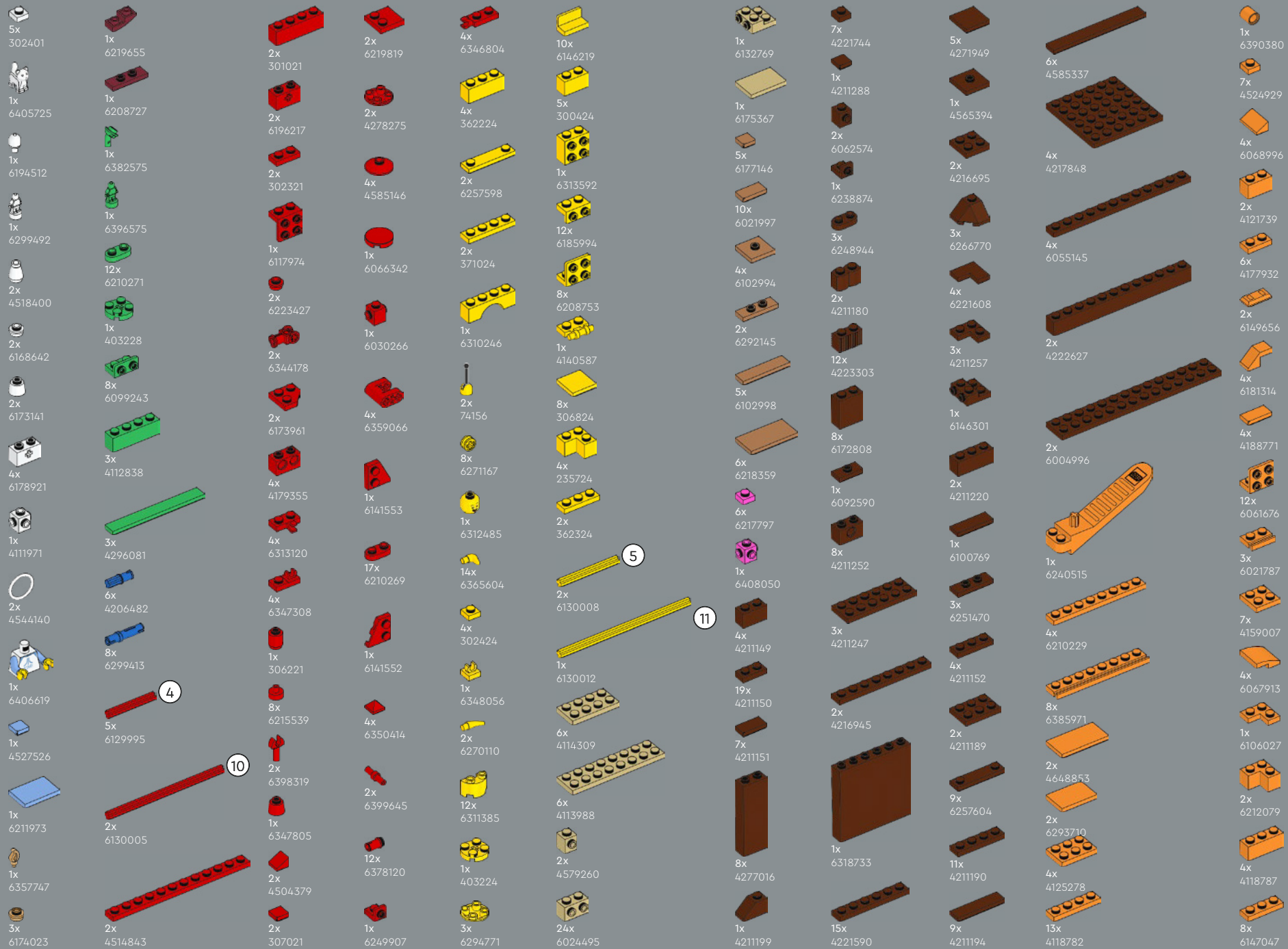

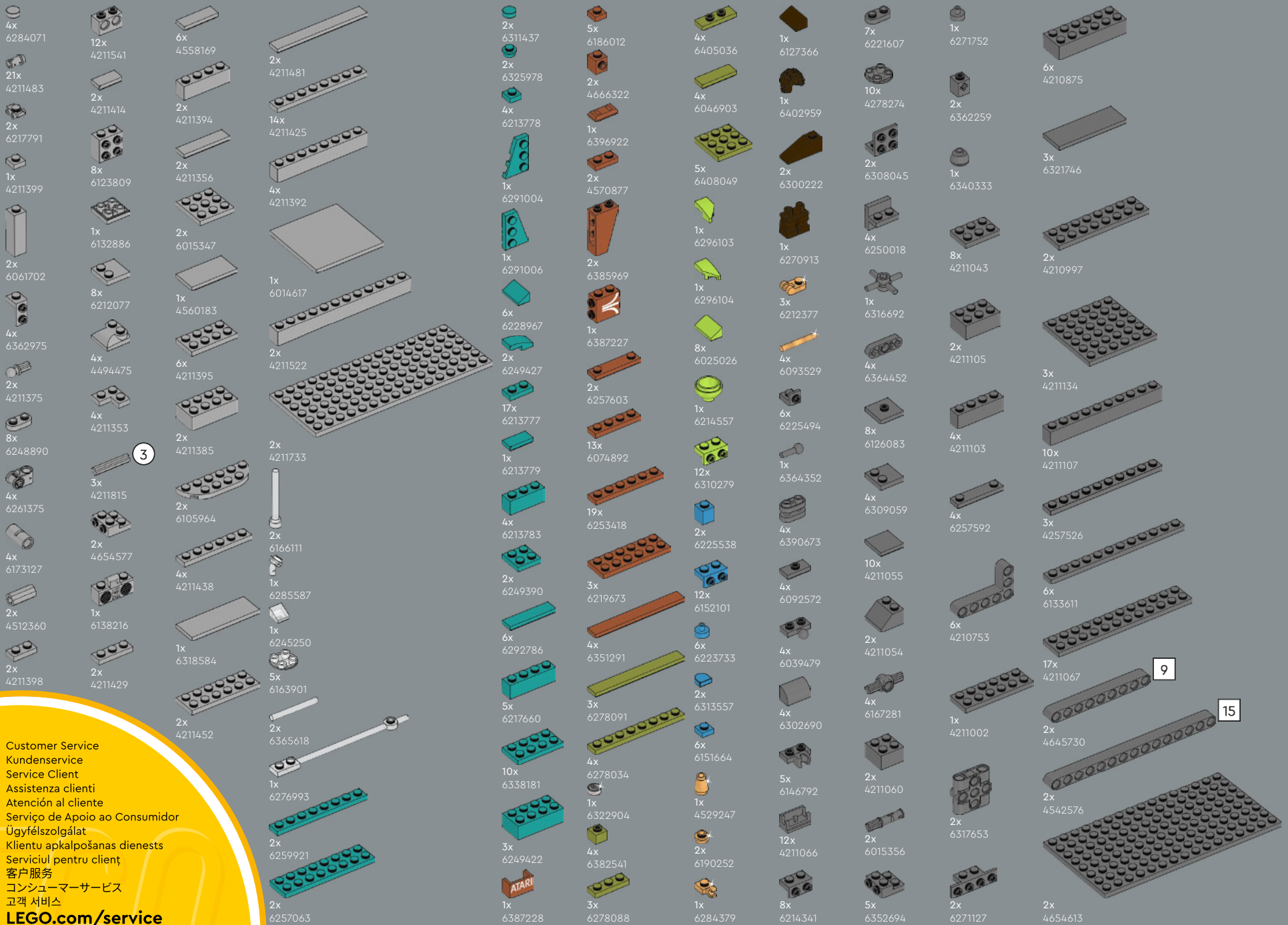

3

9

15

Customer Service
Kundenservice
Service Client
Assistenza clienti
Atención al cliente
Serviço de Apoio ao Consumidor
Ügyfélszolgálat
Klientu apkalpošanas dienests
Serviciul pentru client
客户服务
コンシューマーサービス
고객 서비스
LEGO.com/service



FEEDBACK AND WIN



FEEDBACK AND WIN

Your feedback will help shape the future development of this product series.

Please visit:

FEEDBACK UND GEWINNEN

Dein Feedback trägt zur Weiterentwicklung dieser Produktreihe bei.

Geh auf:

COMMENTEZ ET GAGNEZ

Vos commentaires nous aideront à concevoir les futurs produits de cette gamme.

Rendez-vous sur :

COMENTA Y GANA

Tu opinión nos ayudará a dar forma al desarrollo de esta serie de productos en el futuro.

Visita:

反馈有奖

您的反馈将有助于我们在今后改进本系列产品。

请访问：

[LEGO.com/productfeedback](https://www.lego.com/productfeedback)

By completing, you will automatically enter a drawing to win a LEGO® set.

Terms & Conditions apply.

Durch Ausfüllen nimmst du automatisch an der Verlosung eines LEGO® Preises teil.

Es gelten die Teilnahmebedingungen.

En envoyant vos commentaires, vous serez automatiquement inscrit(e) à un tirage au sort qui vous permettra de remporter un prix LEGO®.

Offre soumise à conditions.

Al contestar, participarás automáticamente en el sorteo y podrás ganar un set LEGO®.

Sujeto a Términos y Condiciones.

完成我们的反馈调查,即可自动进入抽奖环节,赢取乐高®套装。

适用《条款和条件》。

