



CREATOR™

3 IN 1

31134



3 in 1
3 en 1

3 em 1
3 合 1

3 w 1
3 v 1



3 az 1-ben
3 in 1

"3 в 1"
Kolm ühes

3 viename



 **FR**
DONNEZ
OU
RECYCLEZ

 OU  OU 

ASSOCIATION MAGASIN DÉCHÈTERIE

Adresses sur quefairedemesdechets.fr



LEGO.com/sustainable-packaging

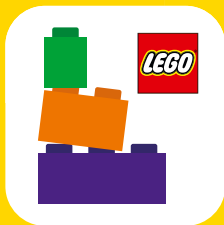

BUILDER



Apple and the Apple logo are trademarks of Apple Inc., registered in the U.S. and other countries and regions. App Store is a service mark of Apple Inc. Google Play and the Google Play logo are trademarks of Google LLC. Tencent and the Tencent logo are trademarks of Tencent Inc.

 LEGO.com/devicecheck

EN Ask parents' permission before going online | **DE** Eltern um Erlaubnis bitten, bevor du online gehst | **FR** Demande l'autorisation d'un parent avant d'aller en ligne | **IT** Chiedi il permesso ai tuoi genitori prima di andare online | **ES** Pídeles permiso a tus papás antes de conectarte a Internet | **PT** Pede autorização aos pais antes de acederes online | **JA** オンラインになる前に ほご者の方のきよかをもらおう | **ZH** 上网前应先征得父母的同意 | **KO** 온라인 접속 전에 보호자 동의가 필요합니다 | **RU** Спроси разрешения у родителей, прежде чем заходить в интернет | **PL** Poproś rodziców o zgodę, zanim wejdiesz do Internetu | **CS** Než půjdeš na internet, požádej rodiče o svolení | **SK** Skôr než pôjdeš na internet, vypýtaj si povolenie od rodičov | **HU** Kérj szülői engedélyt, mielőtt online csatlakoznál! | **RO** Cere permisiunea părinților înainte de a te conecta online | **BG** Поискайте разрешение от родител, преди да влезете онлайн | **LV** Pirms došanās tiešsaistē palūdz atļauju vecākiem | **ET** Enne Interneti kasutamist küsi vanematelt luba | **LT** Prieš prisijungdami prie interneto, atsiklauskite tėvų





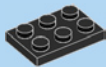

1x



1x

1

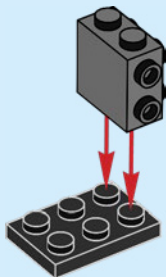



2x

2

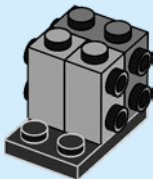



1x

3

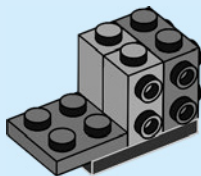

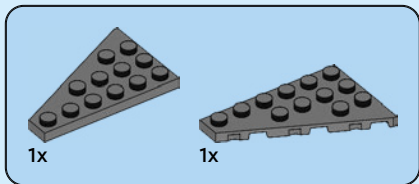

4

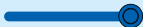
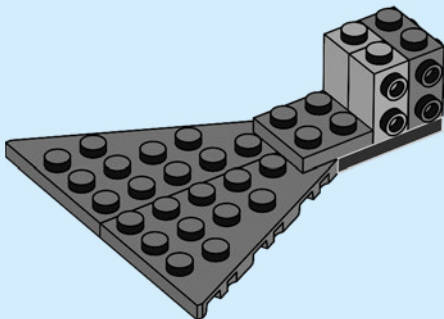



2x

5

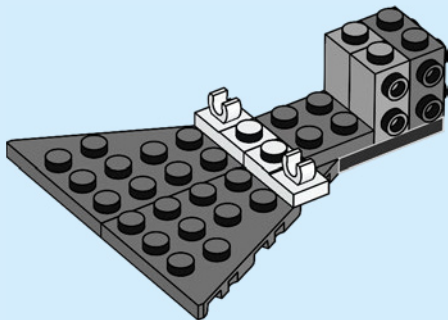

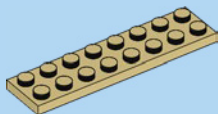

1x

6

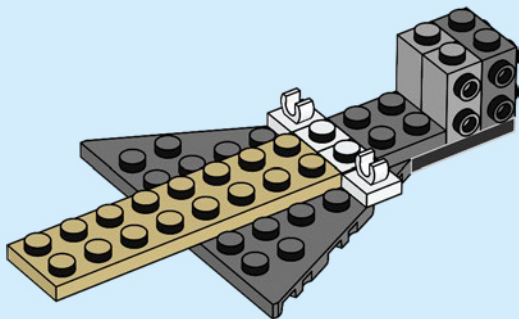



1x

7

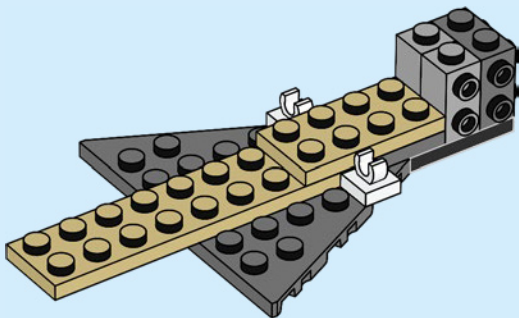



1x



2x

8

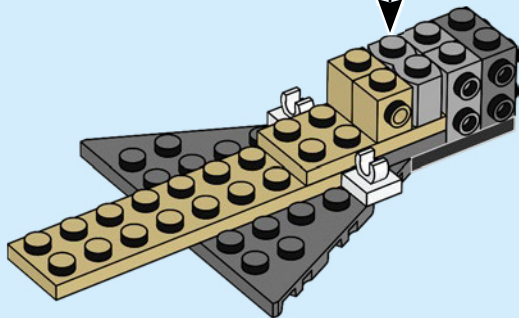
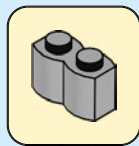



2x

9

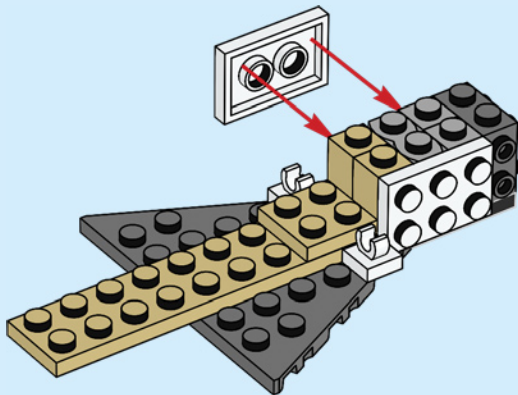



2x



2x

10

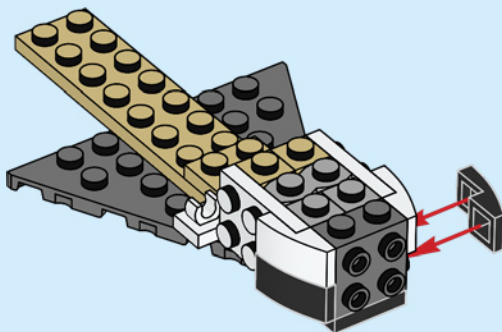
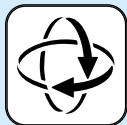



2x

11

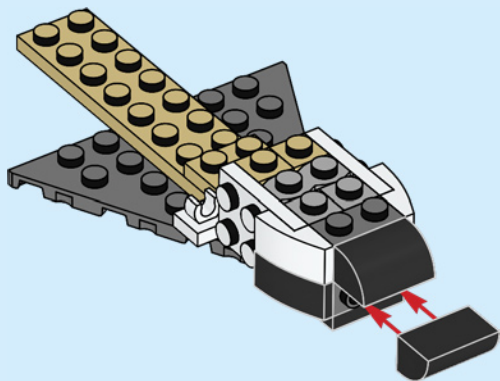

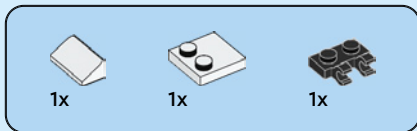

12

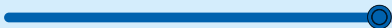
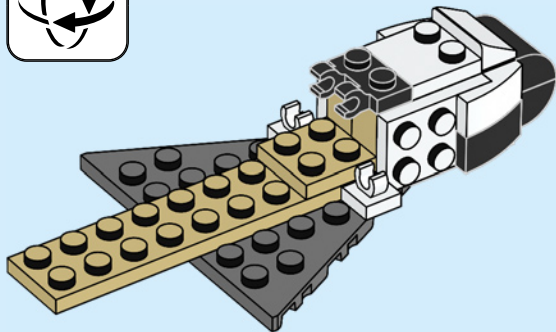
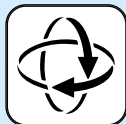



2x

13

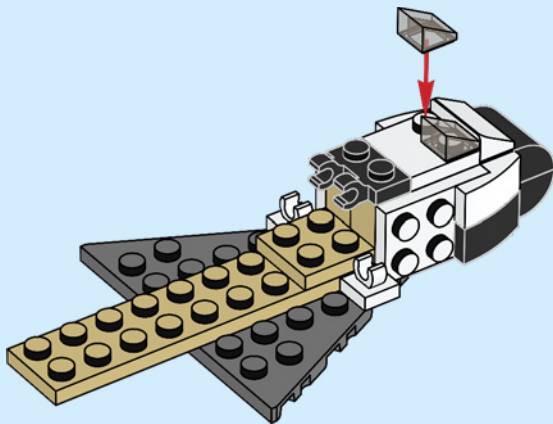

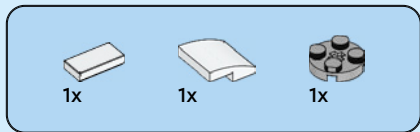

14

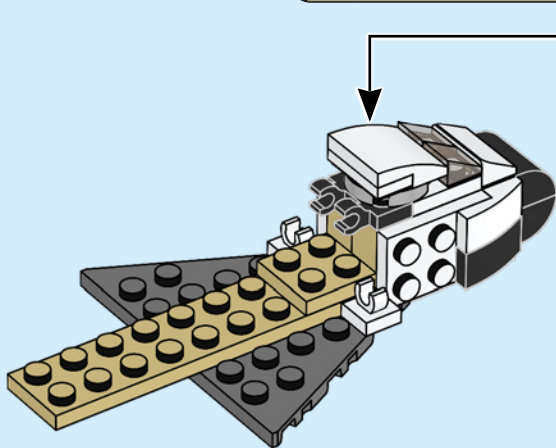
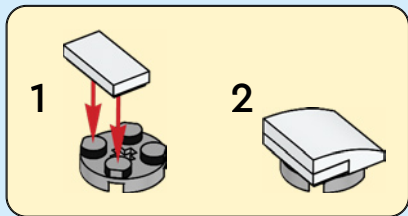



2x



2x

15

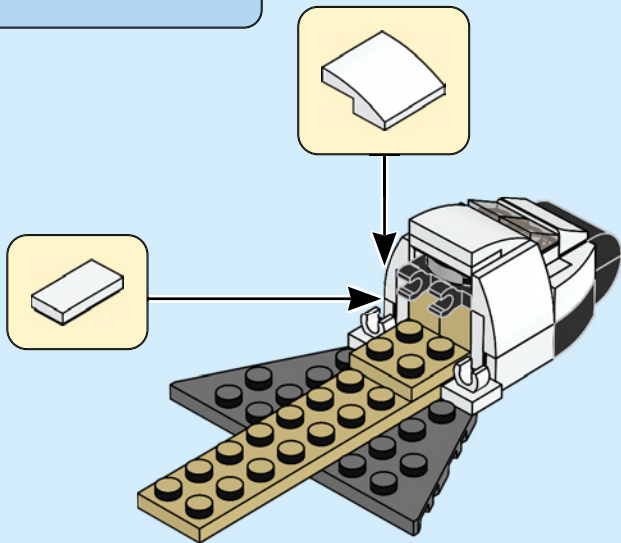



1x



1x

16

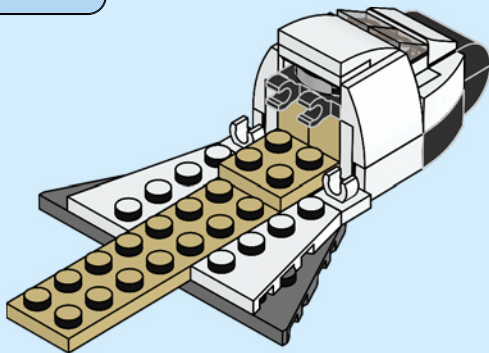

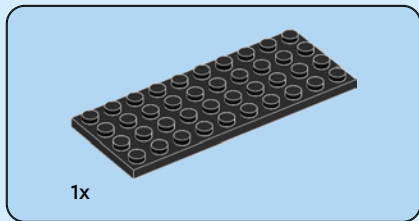

17

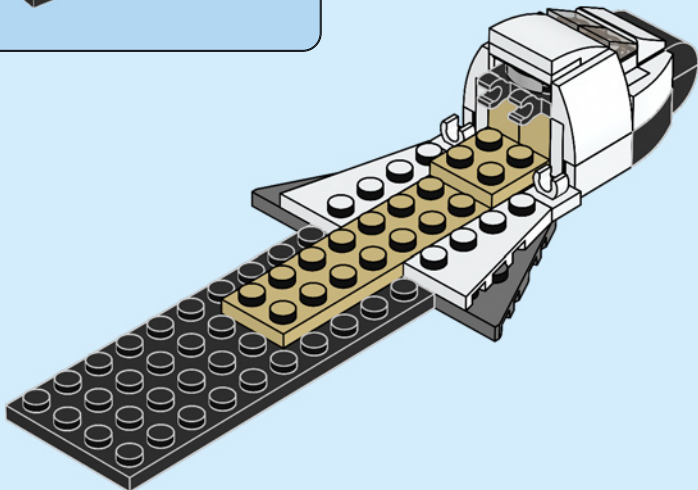



2x

18

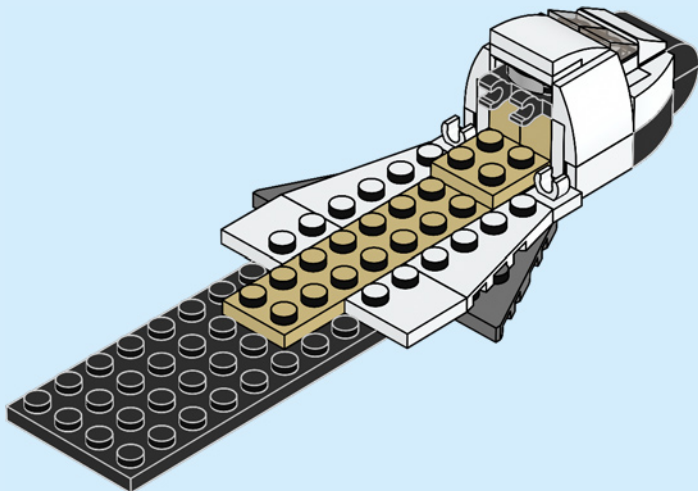



4x

19

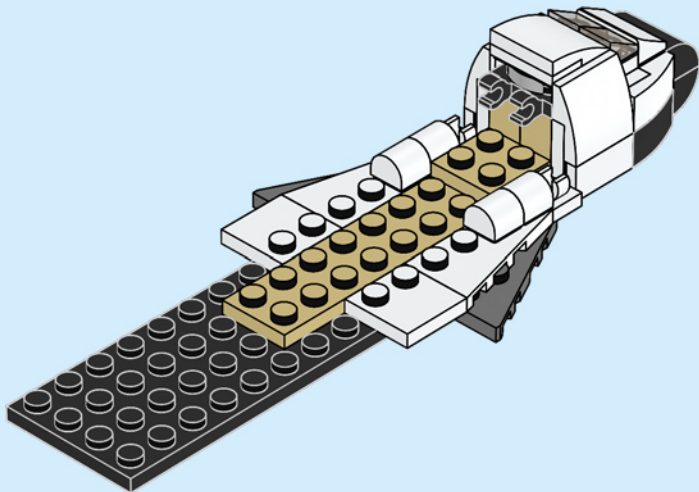



2x

20

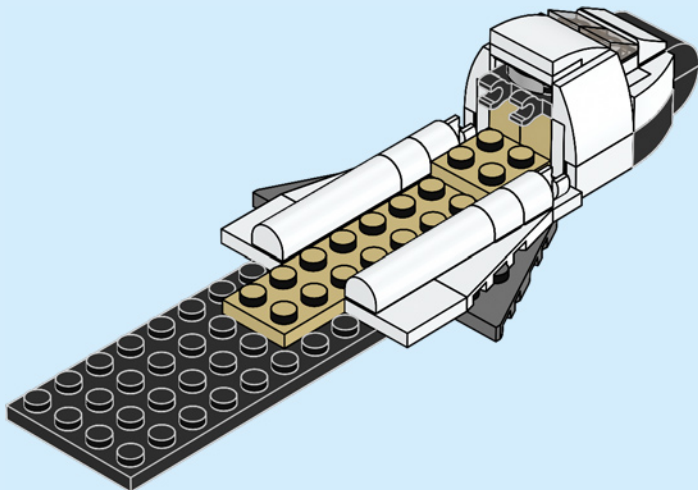

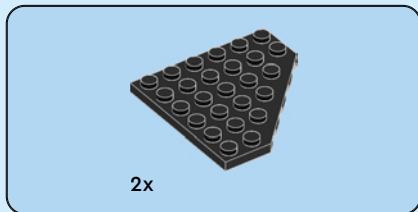

21

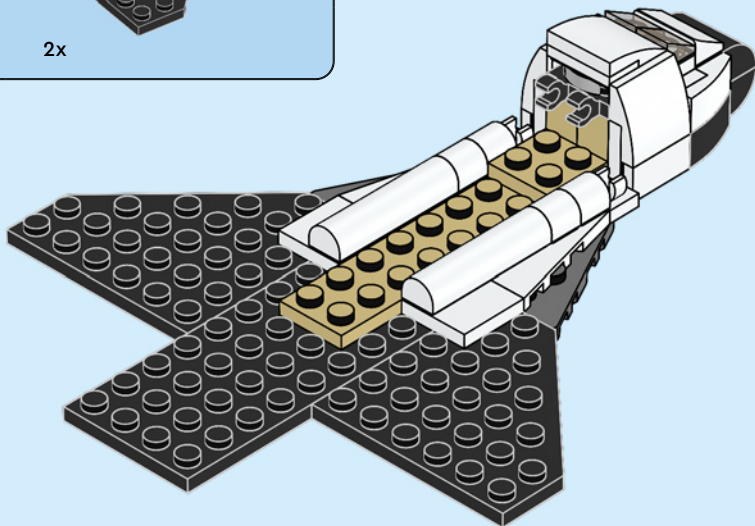



2x

22

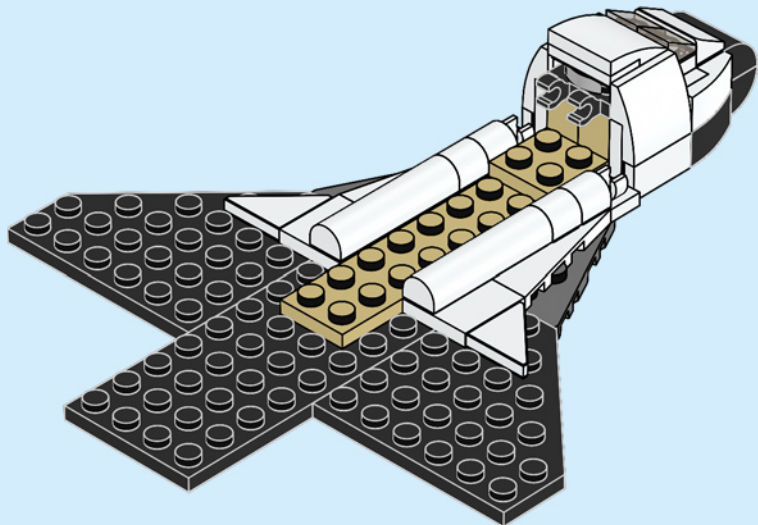



2x



2x

23

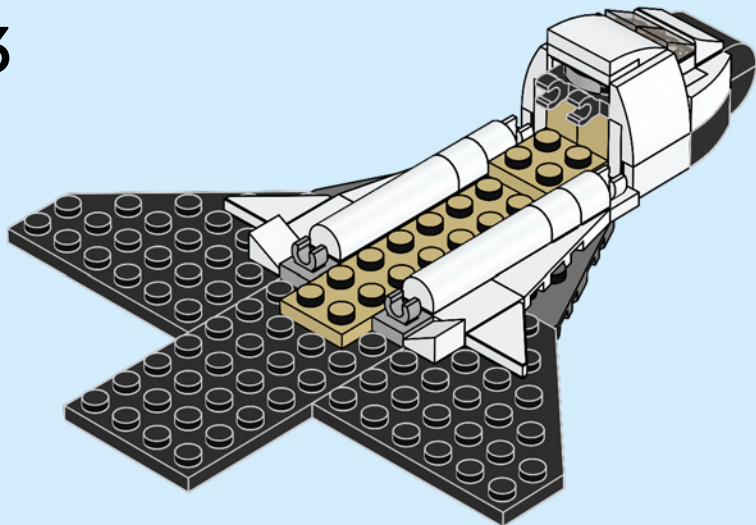



2x



2x

24

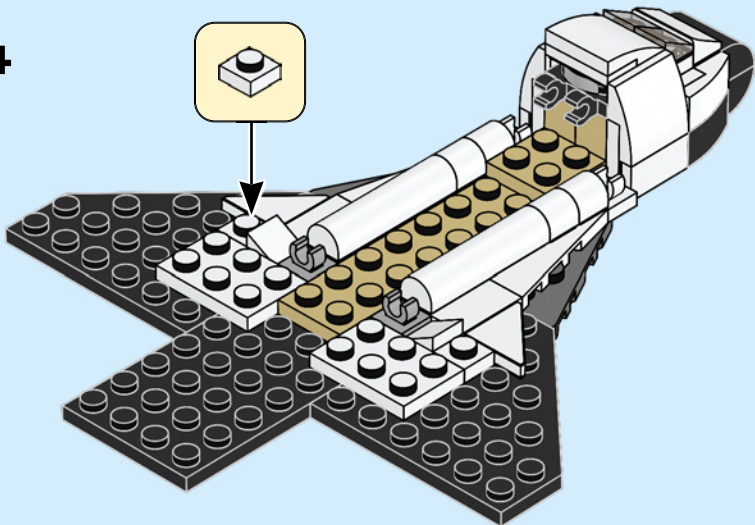



1x



2x

25

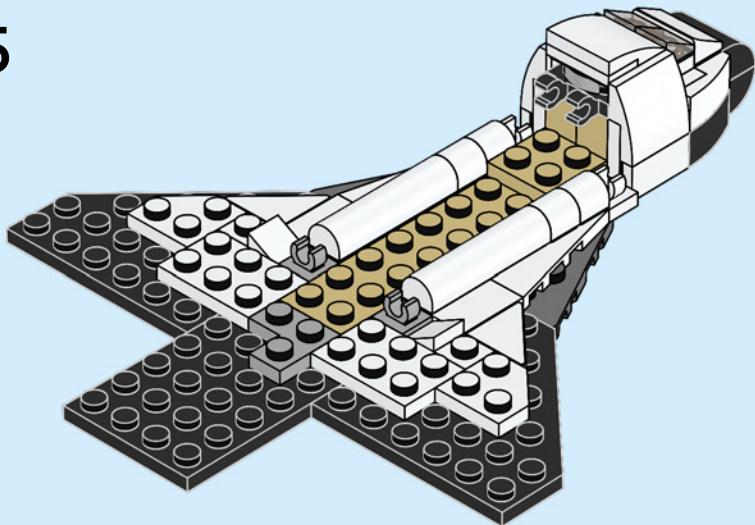



2x



2x



2x



1x

26

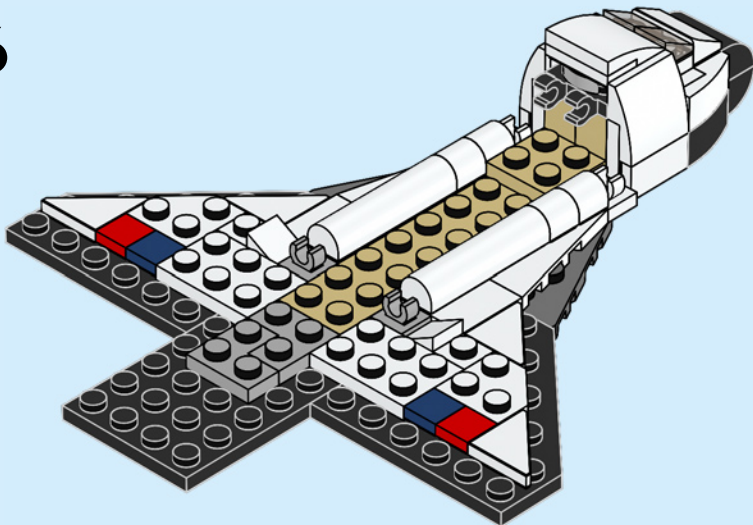

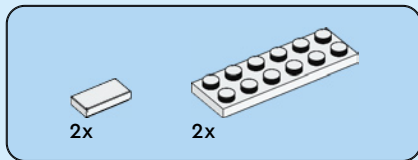

27

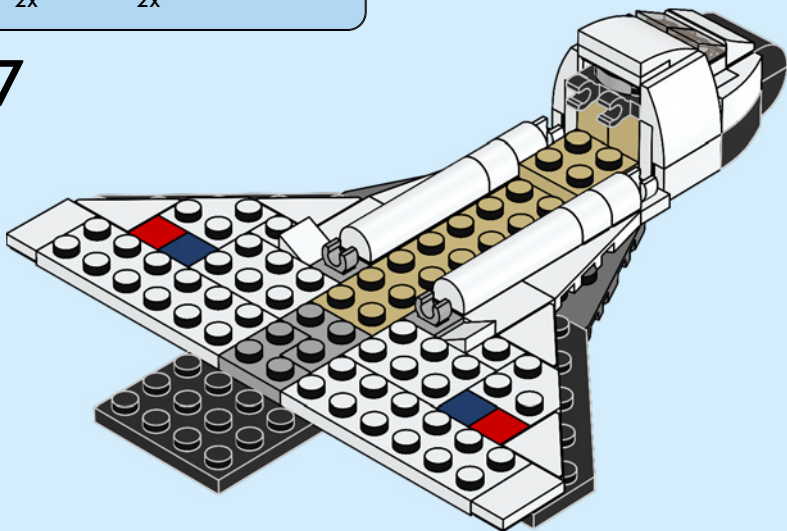



1x

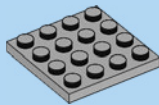

1x

29

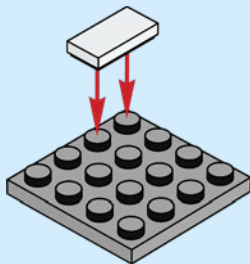

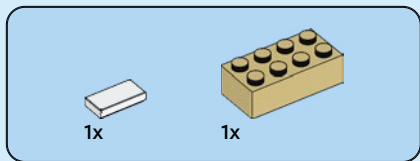

30

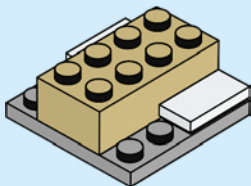



1x

31

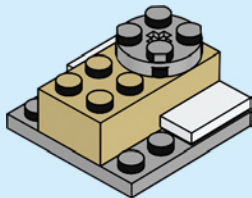



1x



1x

32

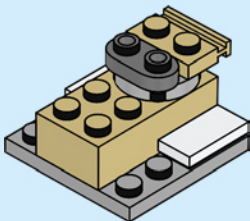



2x

33

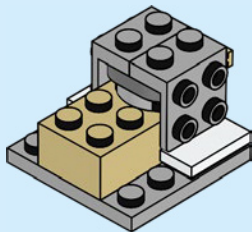



2x

34

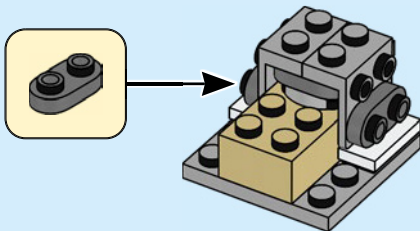



2x

35

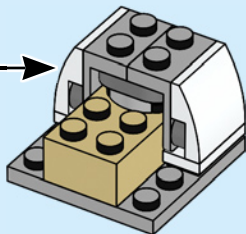



1x



1x

36

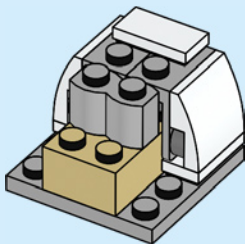



2x



2x

37

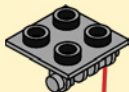

2x

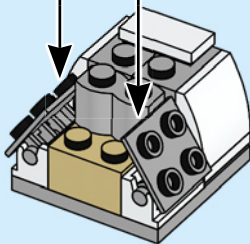

38

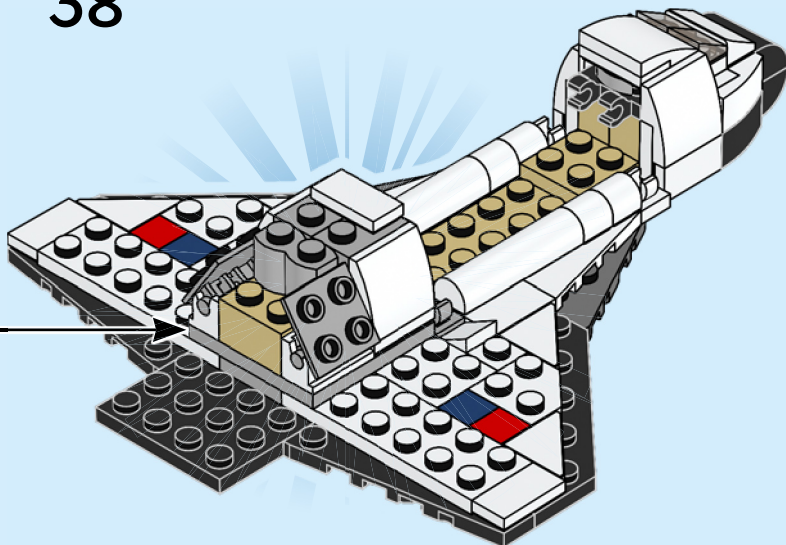

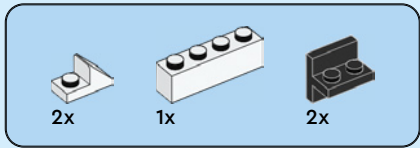

39

1

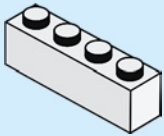

2

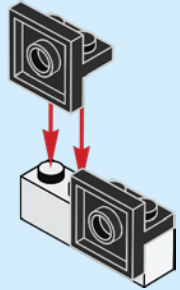

3

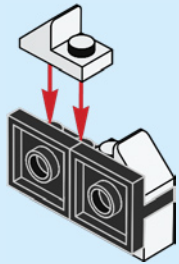

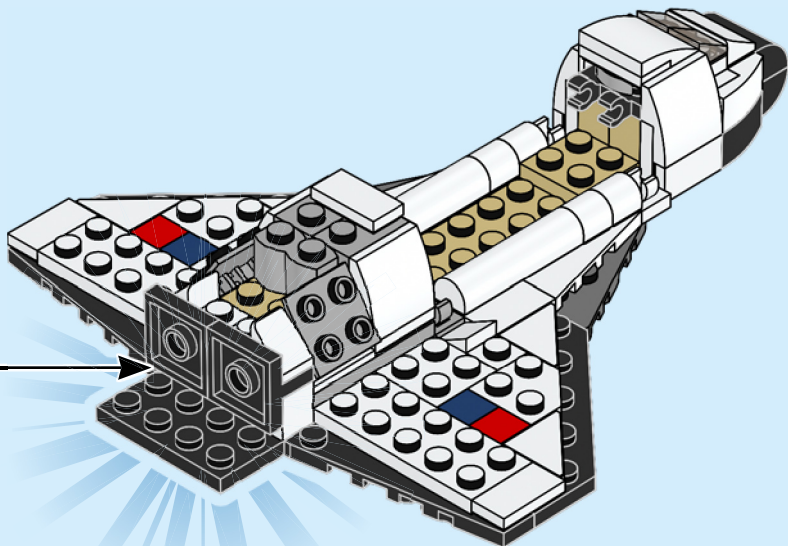



1x



1x



1x

40

1

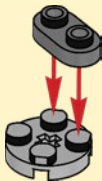

2

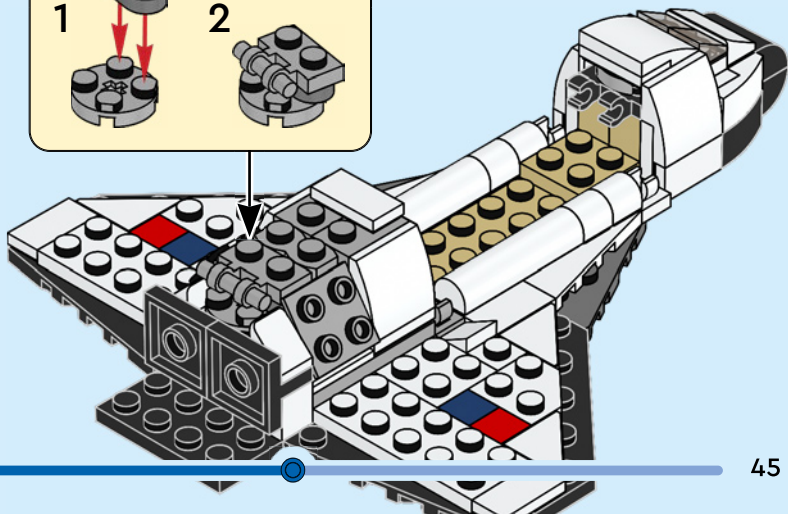



2x



2x

41

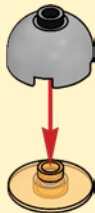

2x

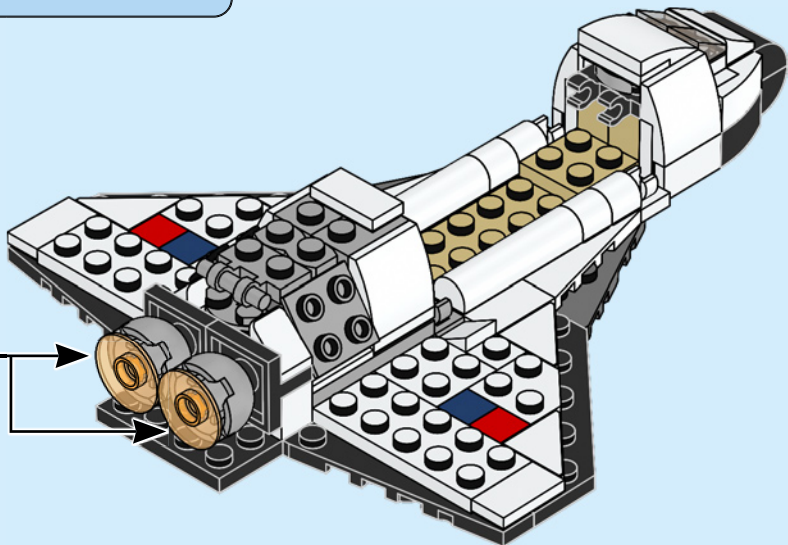



2x

42

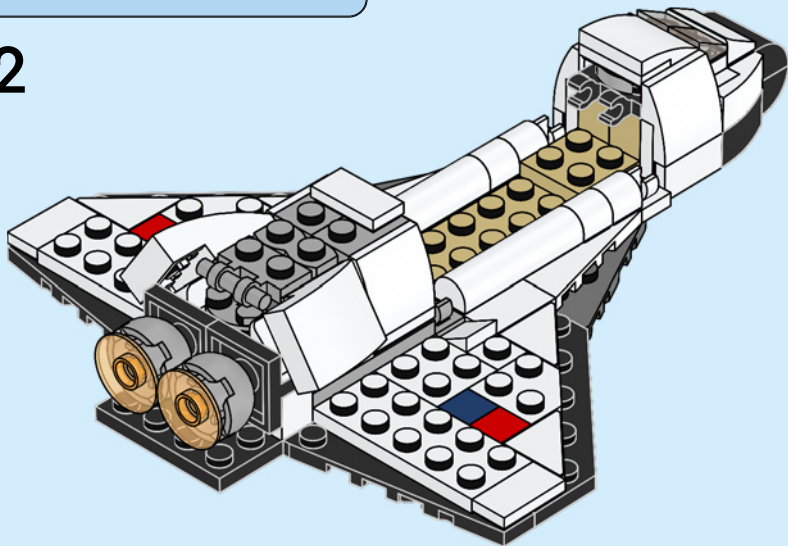

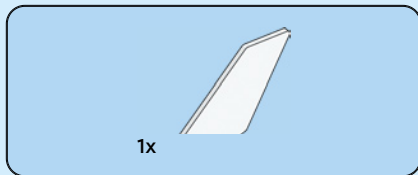

43

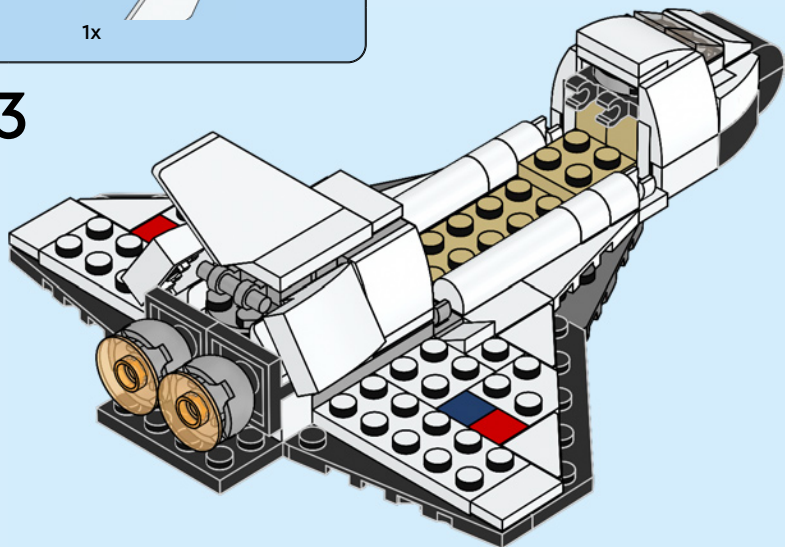



1x



1x



1x

44

1

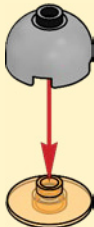

2

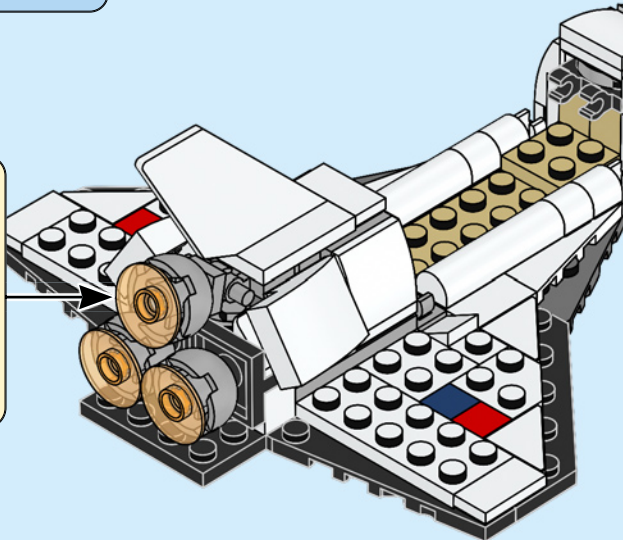



2x



1x



2x

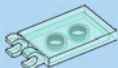

2x

45

1

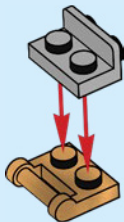

2



3

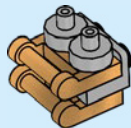

4

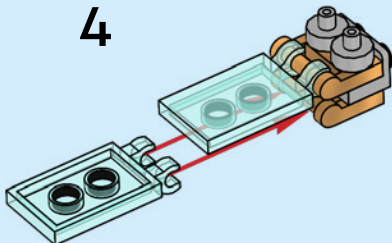

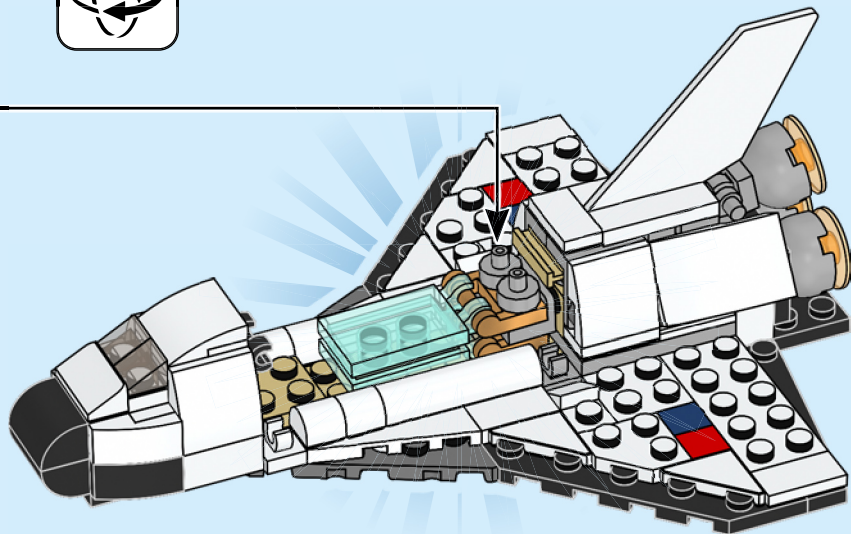
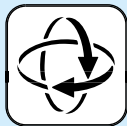

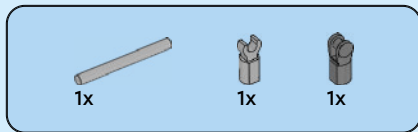

46

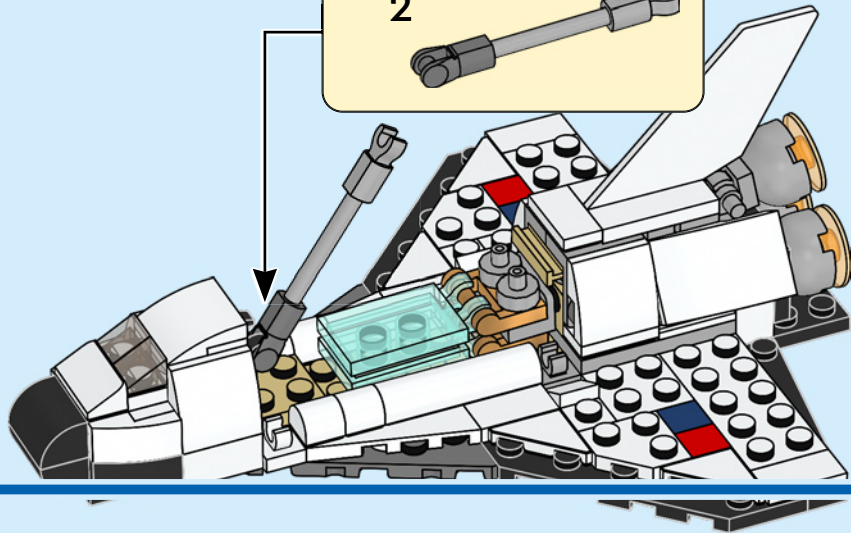
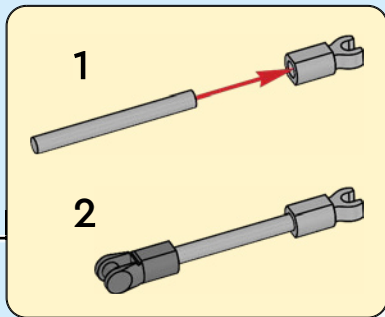

47

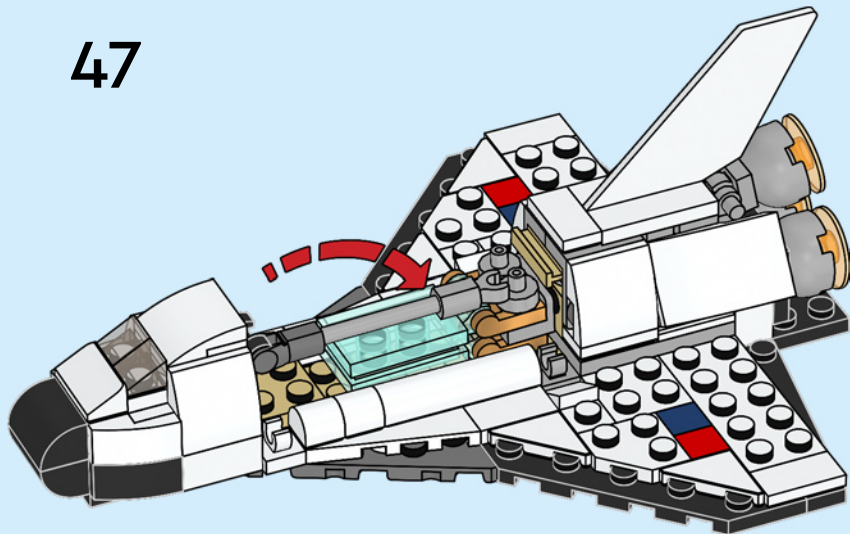



2x



2x



8x



2x



8x



4x

48

1

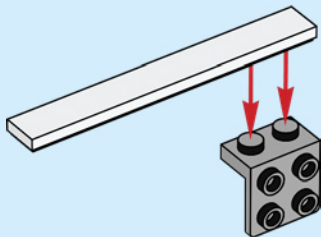

2

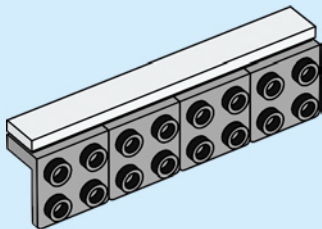

3

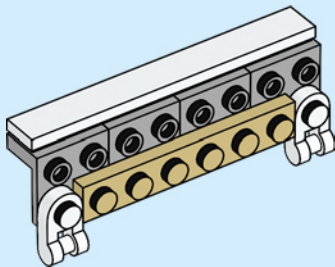

4

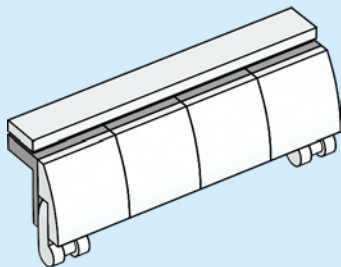

2x

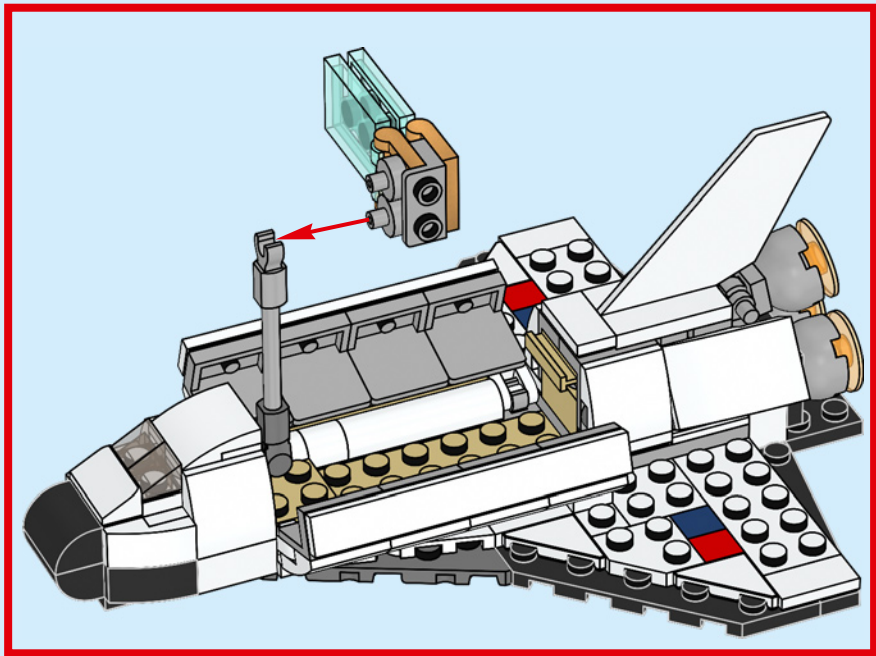

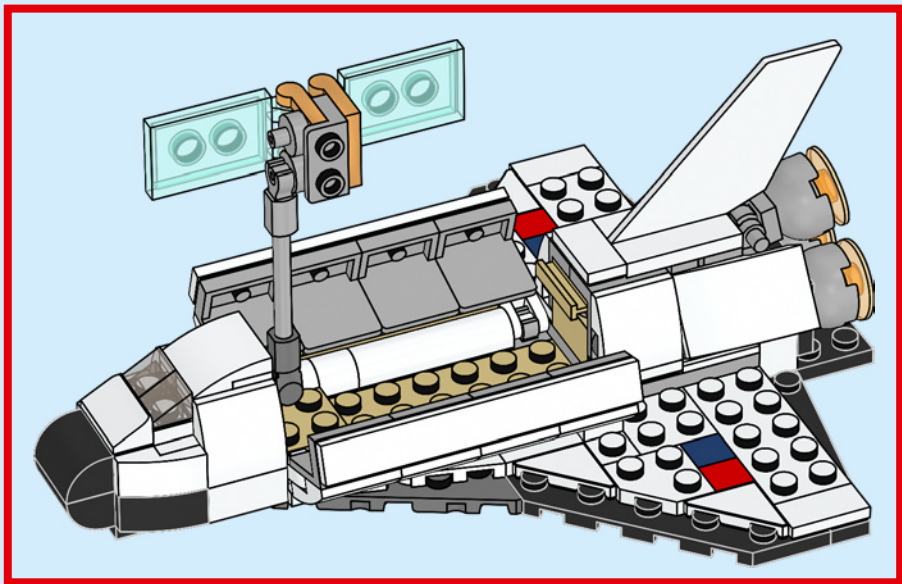

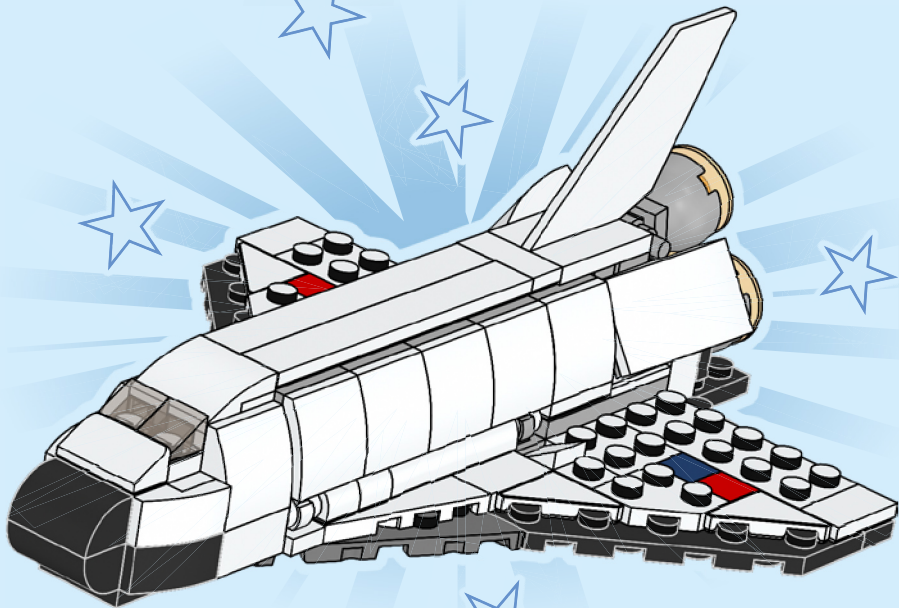



CREATOR™

3 IN 1

31134

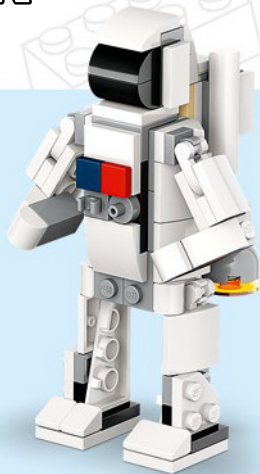

3 in 1
3 en 1

3 em 1
3 合 1

3 w 1
3 v 1

3 az 1-ben
3 ın 1

„3 в 1“
Kolm ühes

3 viename

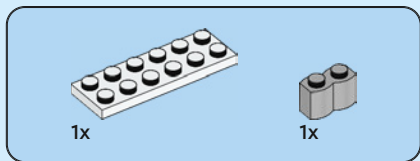

1

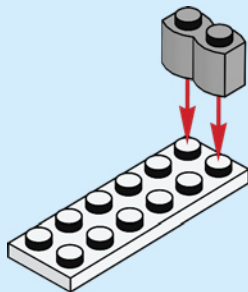

2





1x



1x

2

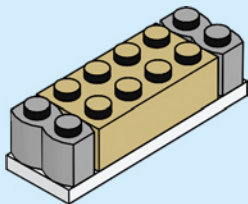



6x

3

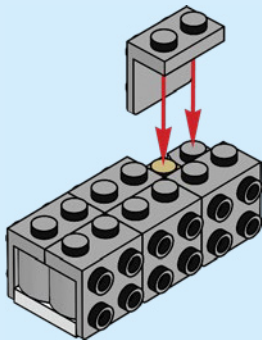

4

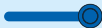

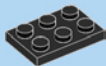

1x



1x

4

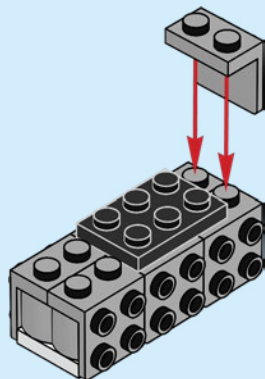



1x



1x



1x



1x

5

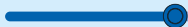
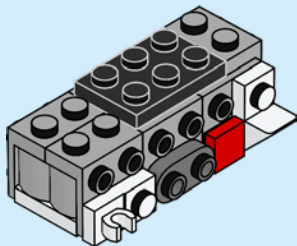



2x



1x



1x

6

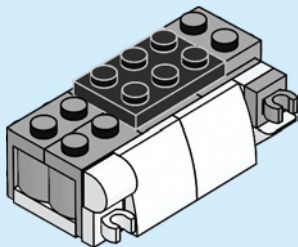



1x



1x



1x



1x

7

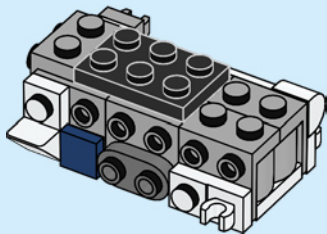



2x



1x



1x

8

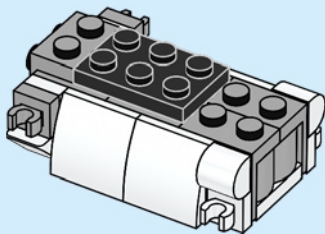

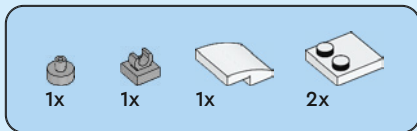

9

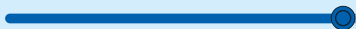
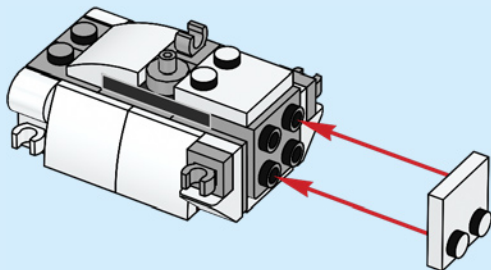



1x



1x

10

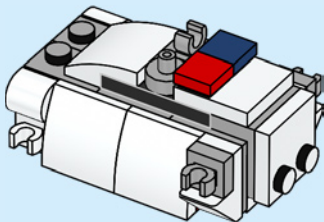



1x



3x



2x



1x



2x

11

1

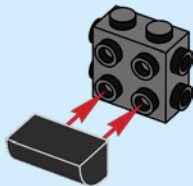

2

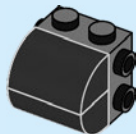

3

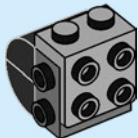

4

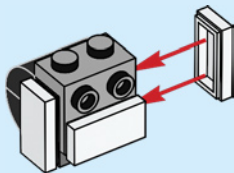

5

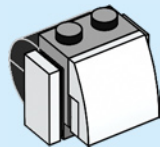

6

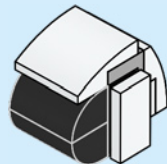

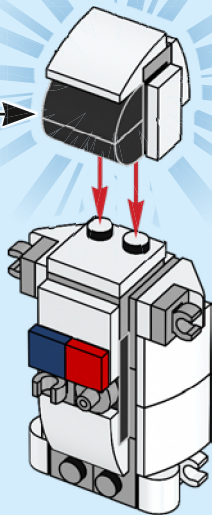
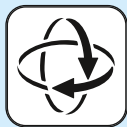



1x

12

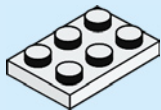



1x

13

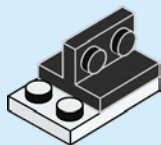

1x

14

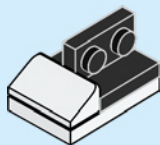

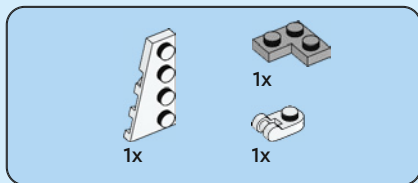

15

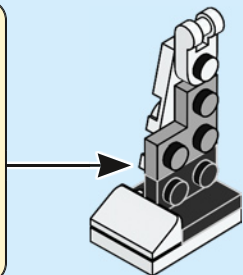
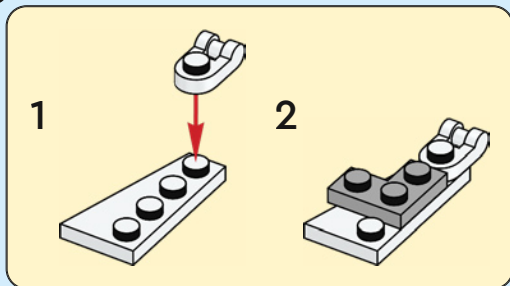



1x

16

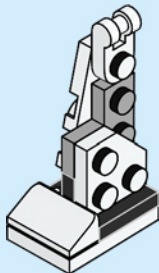

1x

17

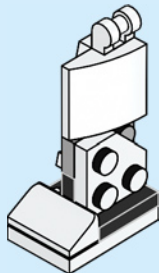

18

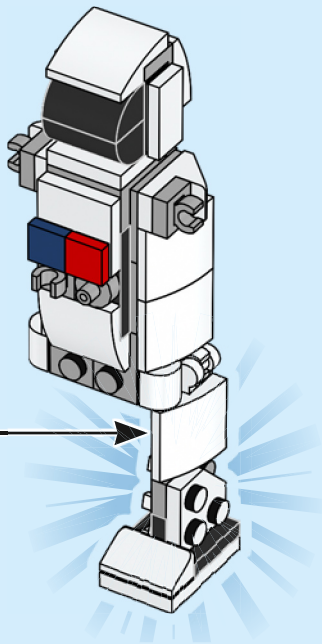



1x

19





1x

20

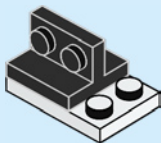

2x

21

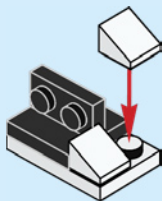

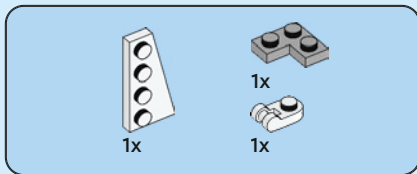

22

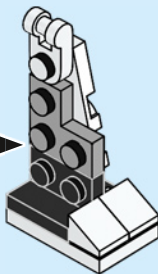
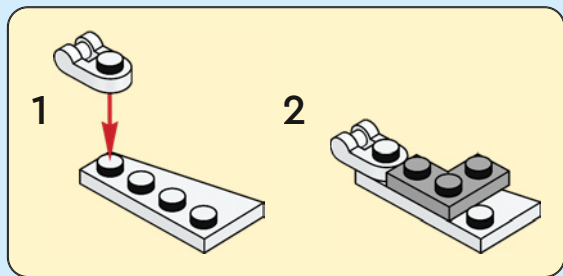



1x

23

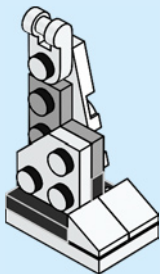

1x

24

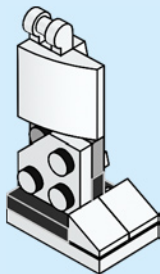

25

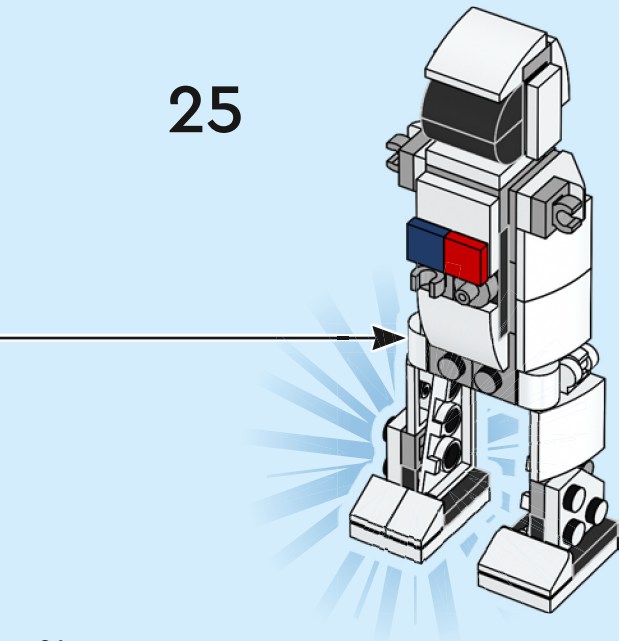

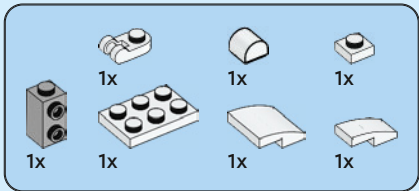

26

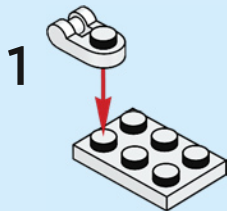

2

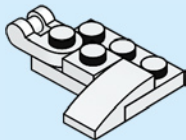

3

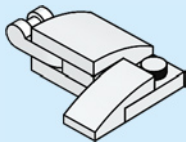

4

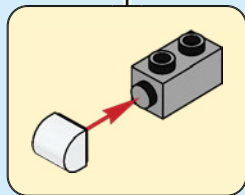
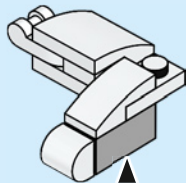

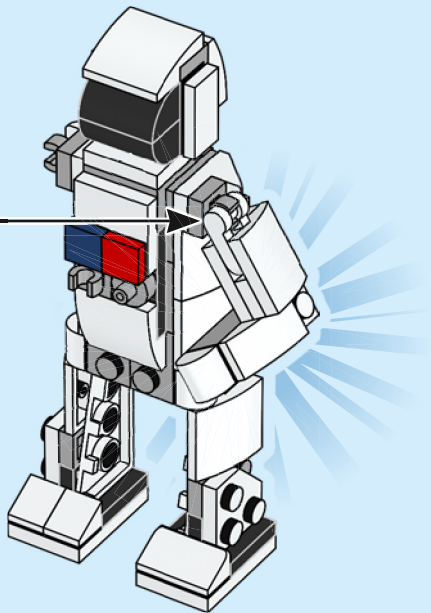



1x



1x



1x



1x



1x



1x



1x

27

1

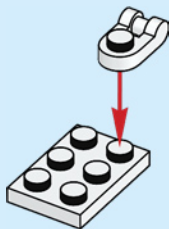

2

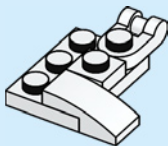

3

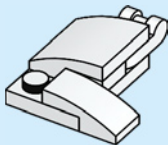

4

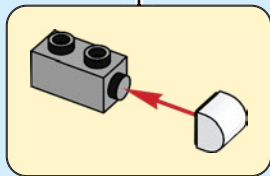
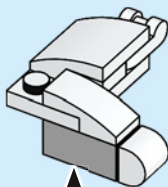

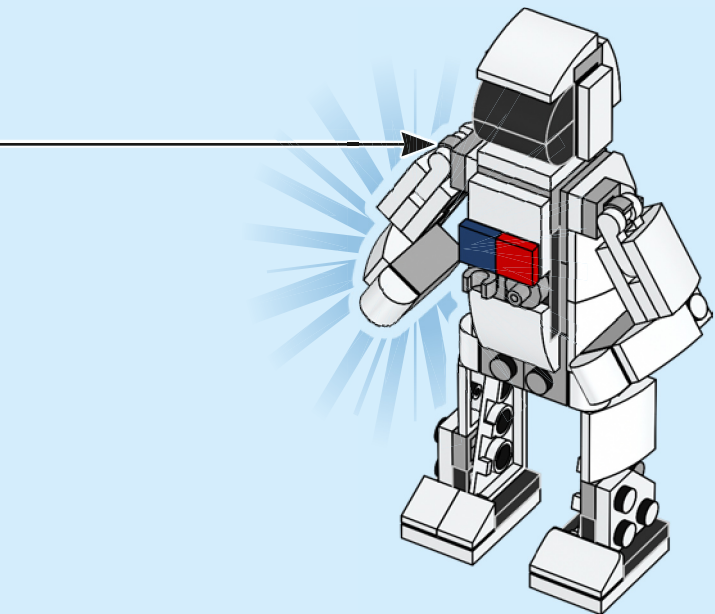

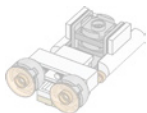

1x



1x

28

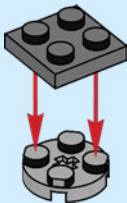

1x

29





1x



1x

30

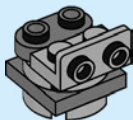

2x

31

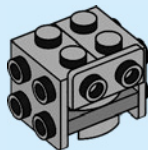



3x

32

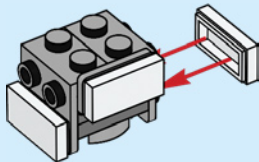

2x

33

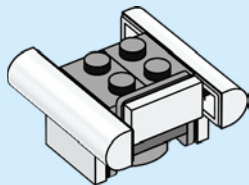

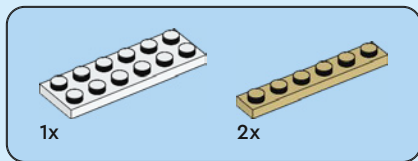

34

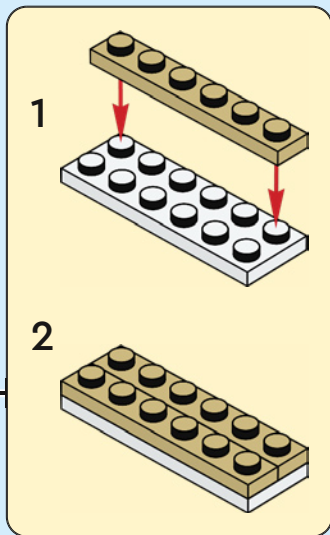
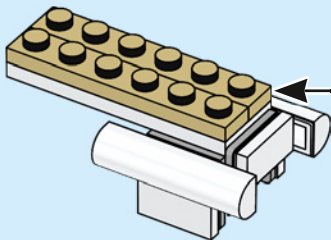



2x



1x

35

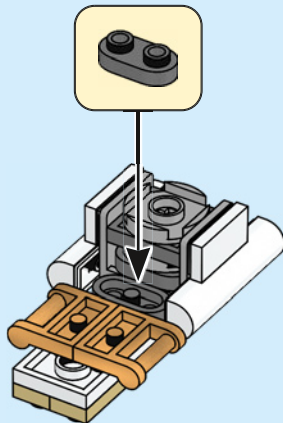

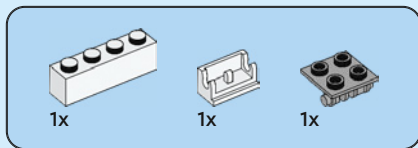

36

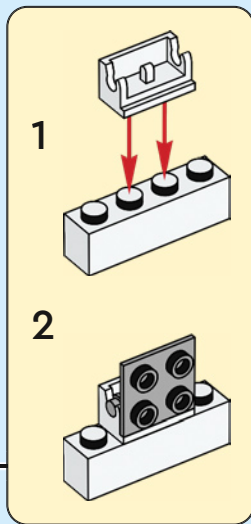
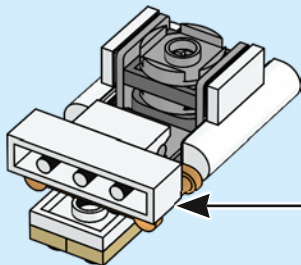



37

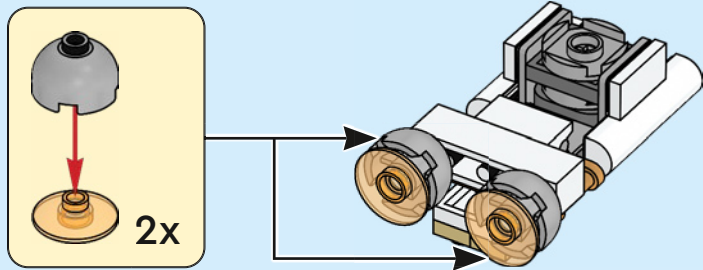



38

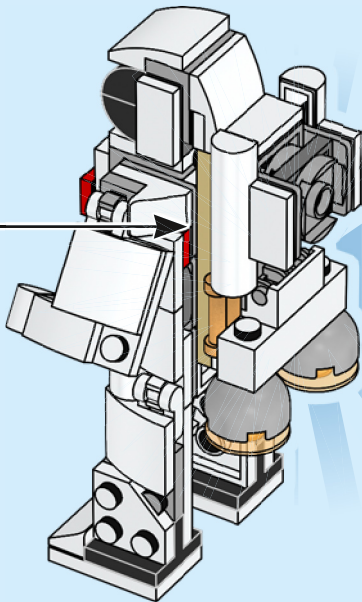

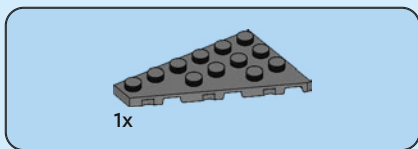
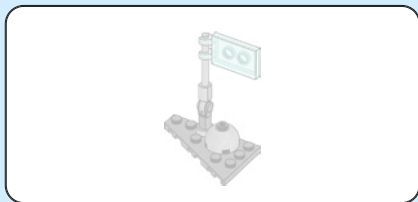

1

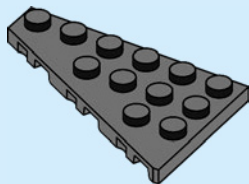



1x



1x



1x

2

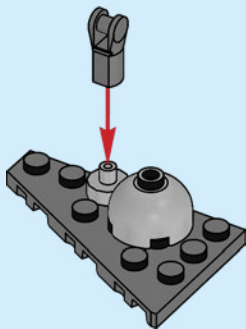

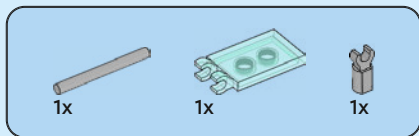

3

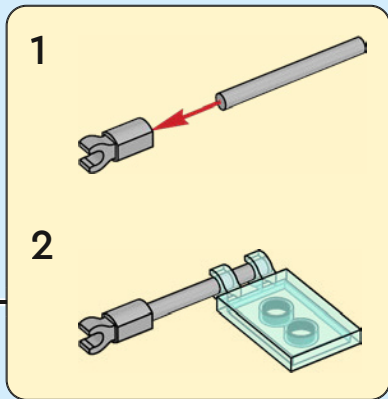
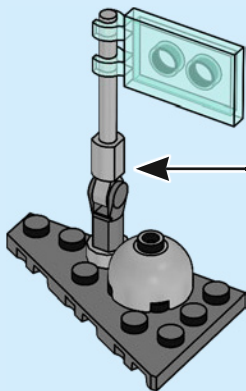

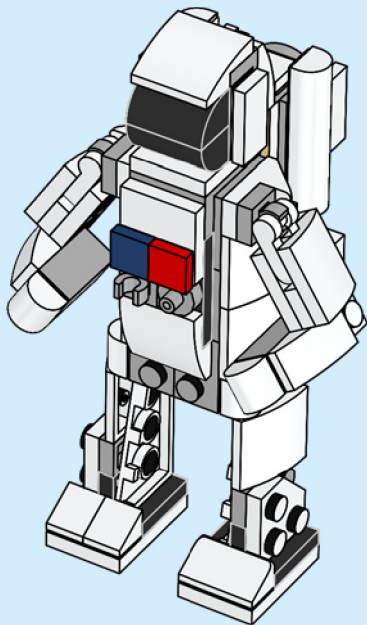
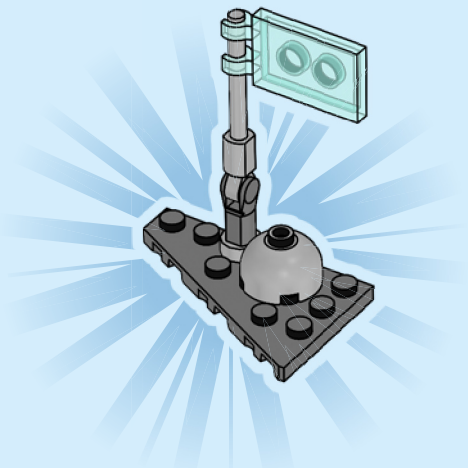

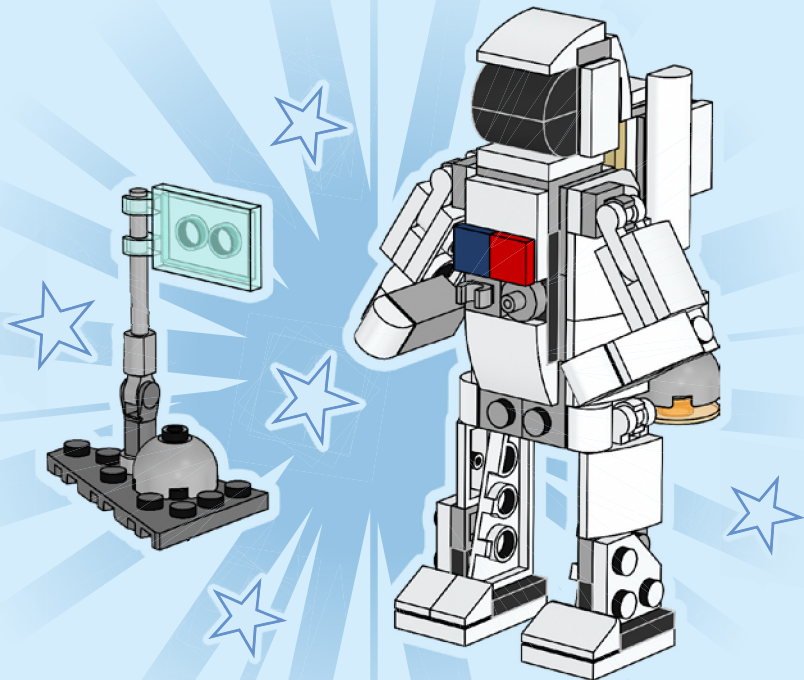



Rebuild
the
world™



LEGO and the LEGO logo are trademarks of the LEGO Group. ©2023 The LEGO Group.
6457821



CREATOR™

3 IN 1

31134



3 in 1
3 en 1

3 em 1
3 合 1

3 w 1
3 v 1

3 az 1-ben
3 in 1

„3 в 1“
Kolm ühes

3 viename

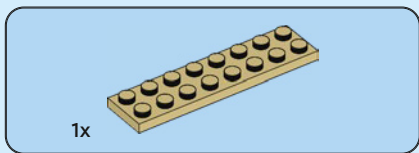

1

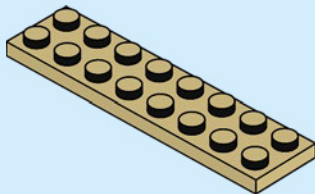

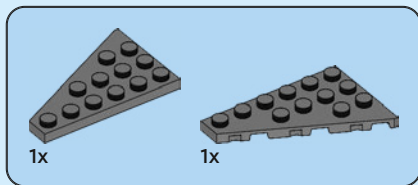

2

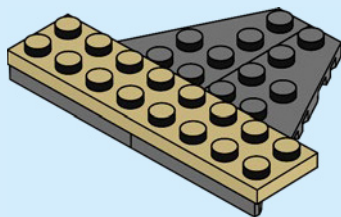

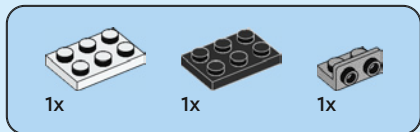

3

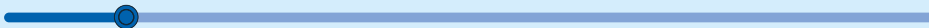
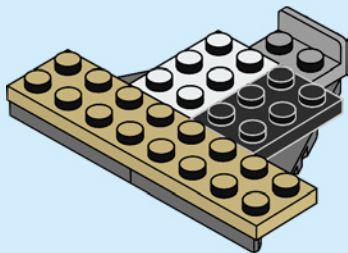

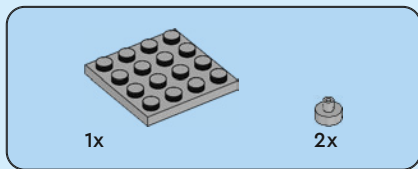

4

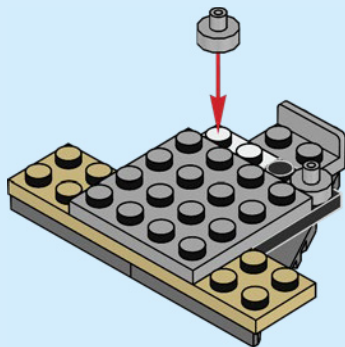



2x



1x



2x

5

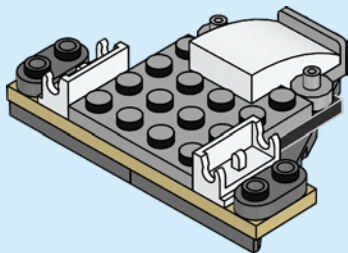

6





2x

6

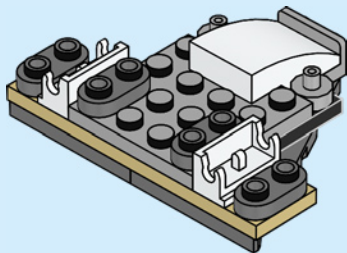



2x

7

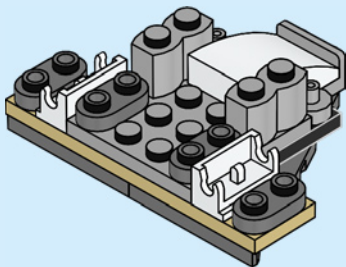

8

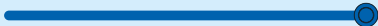



1x



2x

8

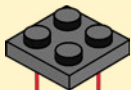

1



2

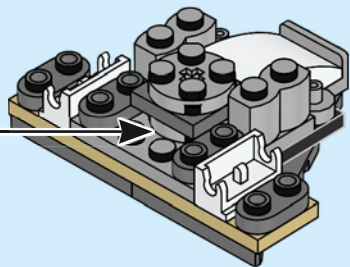



2x



2x

9



2x

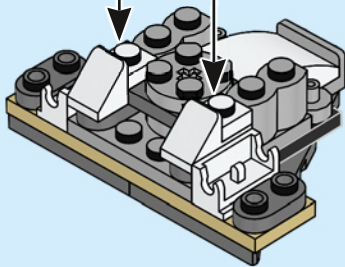



2x

10

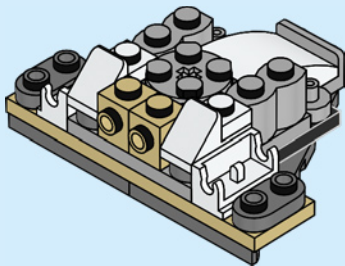



1x



2x

11

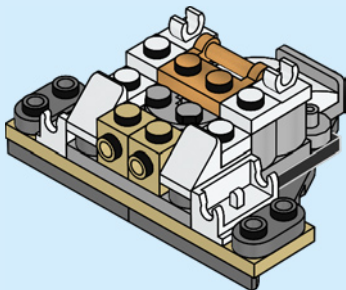



1x



2x

12

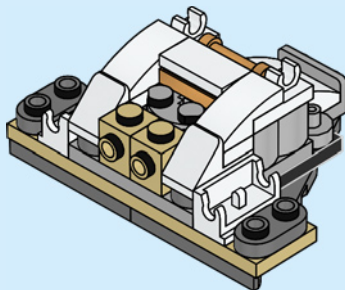

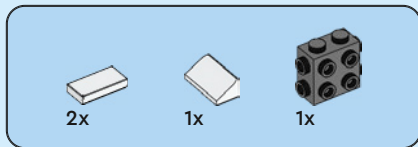

13

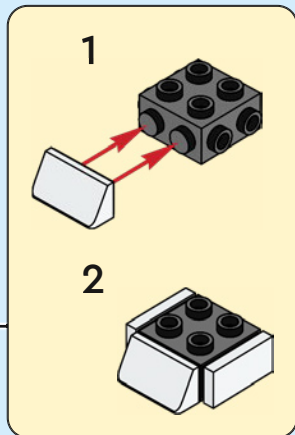
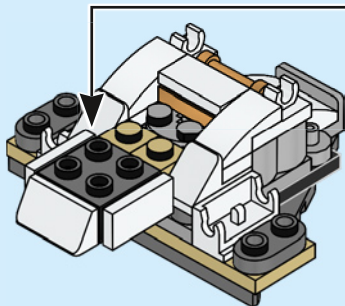

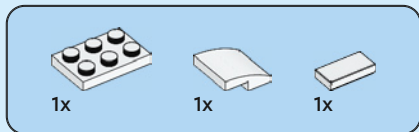

14

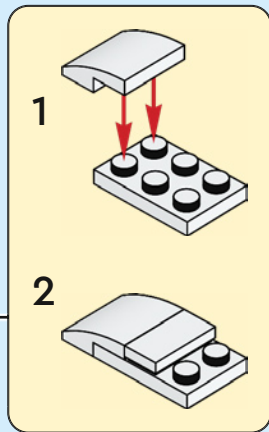
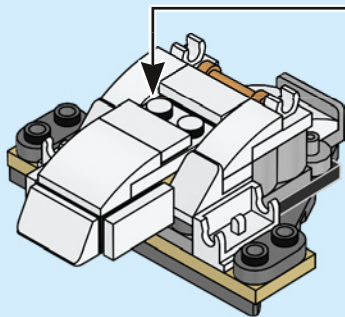



2x

15

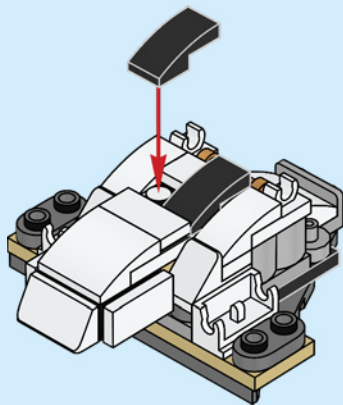



2x



2x

16

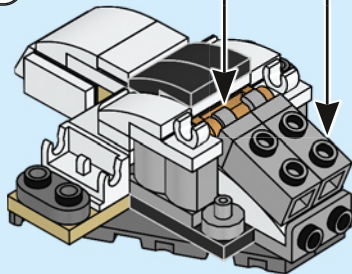

2x

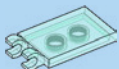

2x

17

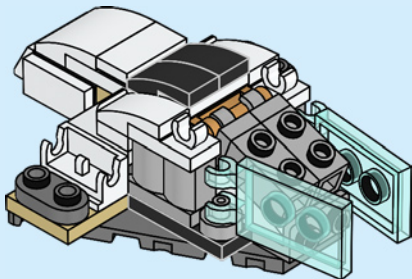



2x

18

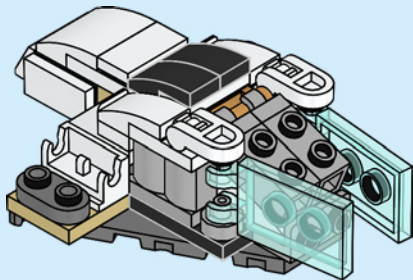

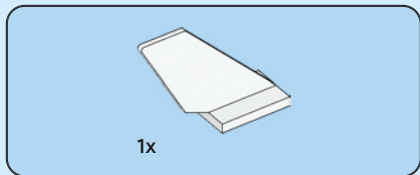

19

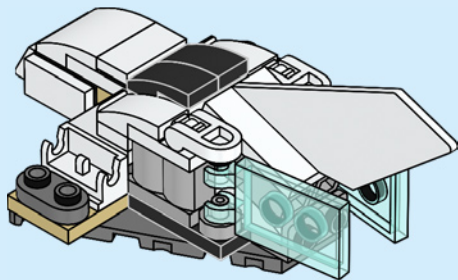

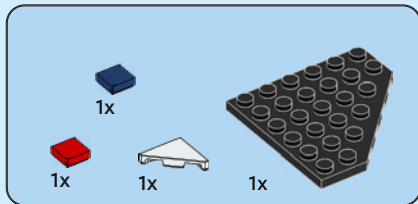
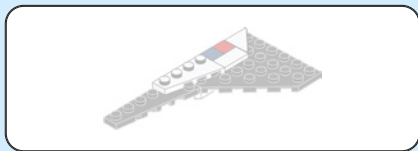

20

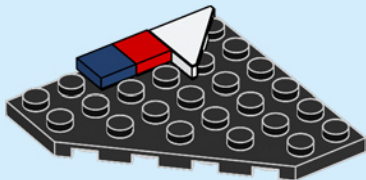

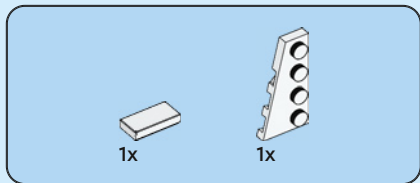

21

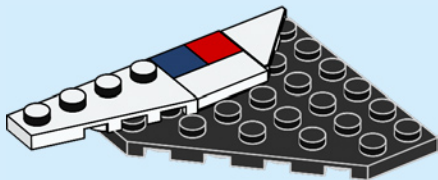

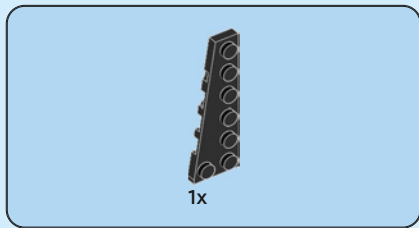

22

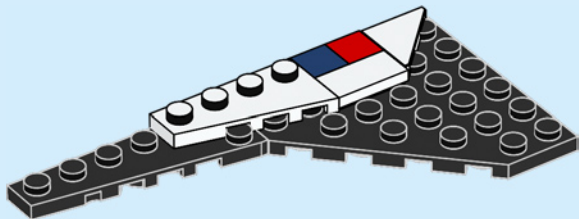

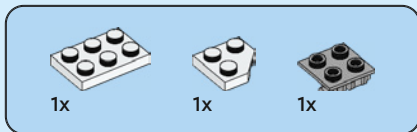

23

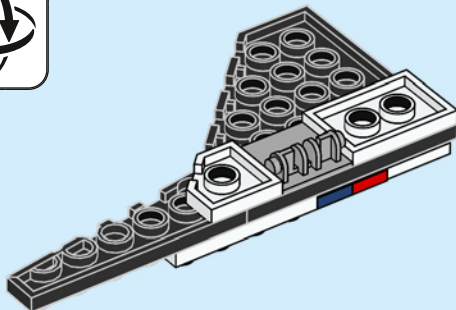

24

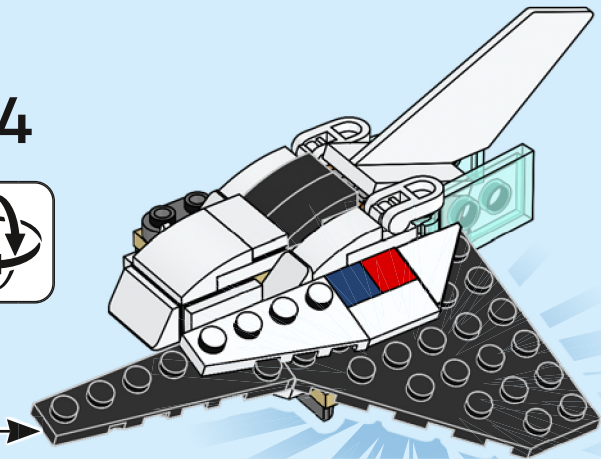

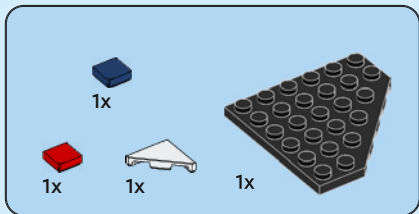
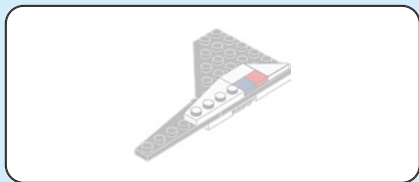

25

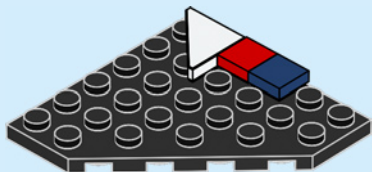

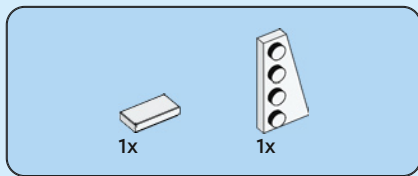

26

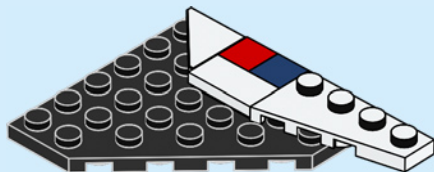



1x

27

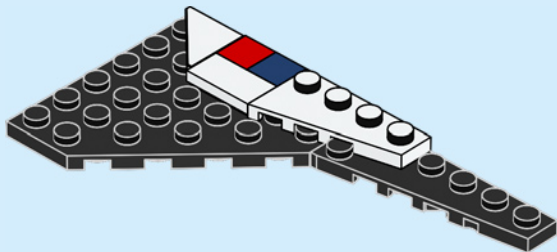



1x



1x



1x

28

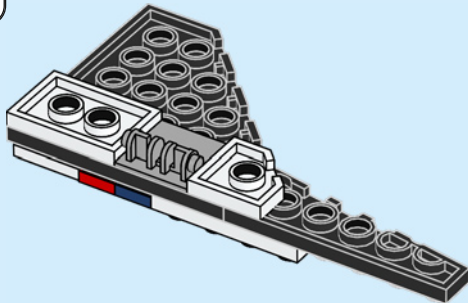

29

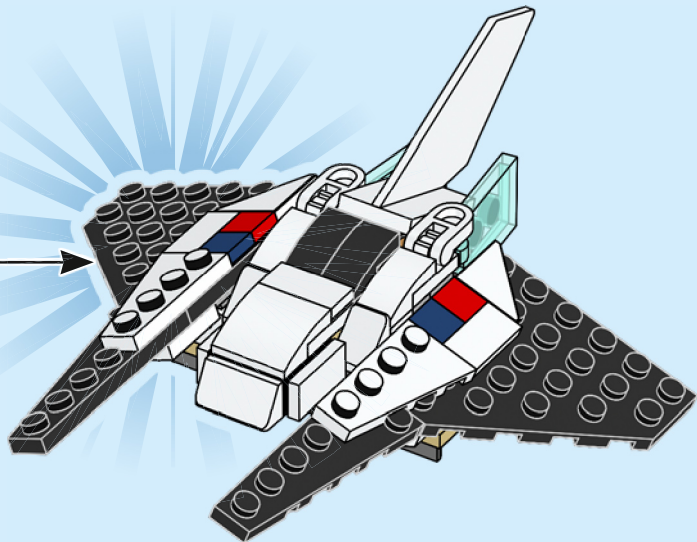

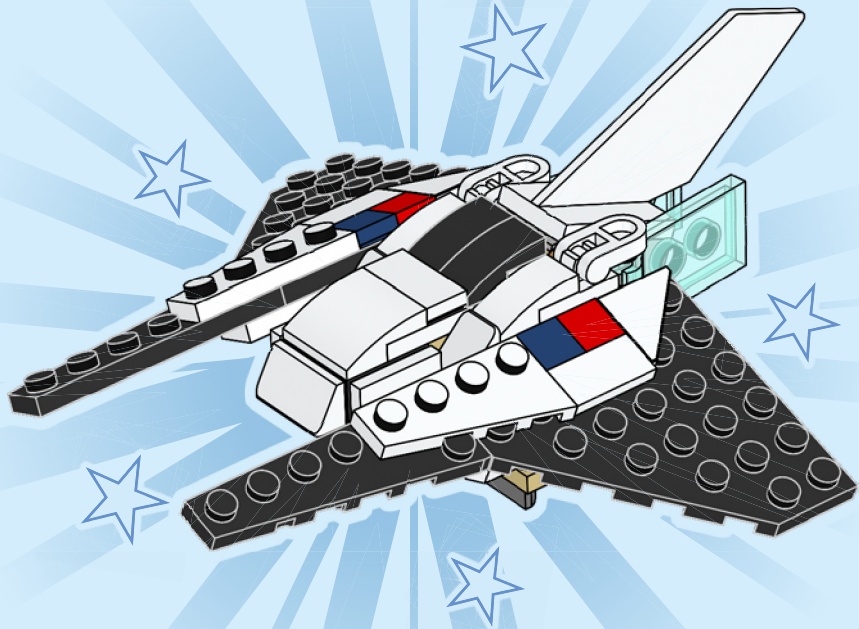



CREATOR™

3 IN 1

31137



31139



31138

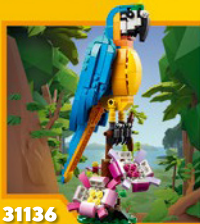

31136

31135



31134



31140



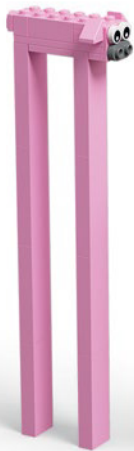

Rebuild
the
world™





2x
4504369



2x
302401



4x
6258135



4x
6174937



1x
4160857



1x
4161326



1x
4547489

34



8x
306901



2x
393701



2x
6347309



2x
6069002



2x
6034044



2x
6176240



4x
6217875



3x
6218822



13x
6047220



4x
302101



2x
6132212



2x
6378416



1x
301001



1x
623901



2x
379501



2x
416201



2x
4579260



1x
4160483



1x
4114319



1x
4114309



2x
4124067

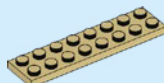

1x
4113988



2x
6047276



1x
6310268



2x
6250020



1x
302126

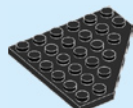

2x
4106977

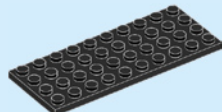

1x
303026



3x
6245310



2x
307021



2x
4585493



2x
6275732



1x
6344427



1x
6344428



2x
6245263



2x
4631385



1x
6355025



2x
6258831



3x
6308012



2x
6225242



3x
6429052



3x
4211475



2x
4550325



10x
6117967



1x
6004990



1x
4211632



2x
4211353



2x
4211881



1x
6116608



1x
4243797



1x
6397633



4x
6221607



1x
6314192



1x
4211094



1x
6266299



1x
6266298



2x
6348063



LEGO.com/service

YOU COULD

WIN



Scan this QR code or go to
LEGO.COM/PRODUCTFEEDBACK and give us
your short feedback about this LEGO® set
for a chance to win a cool LEGO prize.

Terms and Conditions apply*

DE: Du könntest GEWINNEN. Es gelten die Teilnahmebedingungen* **FR: Tu pourrais GAGNER.** Des conditions s'appliquent* **IT: Potresti VINCERE tu.** Termini e condizioni sono applicabili* **ES: Puedes GANAR.** Aplican términos y condiciones* **PT: Poderá GANHAR.** Aplicam-se termos e condições* **JA: プレゼント付き! 利用規約が適用されます*** **ZH: 轻松获奖. 条款和条件适用*** **KO: 상품의 주인이 되어보세요. 소정의 약관이 적용됩니다*** **RU: Вы можете ВЫИГРАТЬ.** Действуют положения и условия* **PL: Szansa na WYGRANĄ.** Obowiązują warunki korzystania* **CS: Máte šanci VYHRÁT.** Platí všeobecné smluvní podmínky* **SK: Máte šancu VYHRATĚ.** Platia všeobecné zmluvné podmienky* **HU: TE IS NYERHETSZ.** Felhasználási feltételek érvényesek* **RO: Ai putea CĂȘTIGA.** Se aplică termenii și condiții* **BG: Можете да СПЕЧЕЛИТЕ.** Има определени правила и условия* **LV: Tu vari LAIMĒT.** Ir spēkā noteikumi un nosacījumi.* **ET: Sul on võimalus VÕITA.** Kehtivad tingimused* **LT: Jūs galite LAIMĖTI.** Taikomos sąlygos*

*[LEGO.com/productfeedback-terms](https://www.lego.com/productfeedback-terms)